

PREFACE

In a bid to standardize higher education in the country, the University Grants Commission (UGC) has introduced Choice Based Credit System (CBCS) based on five types of courses viz. *core, discipline specific, generic elective, ability and skill enhancement* for graduate students of all programmes at Honours level. This brings in the semester pattern, which finds efficacy in sync with credit system, credit transfer, comprehensive continuous assessments and a graded pattern of evaluation. The objective is to offer learners ample flexibility to choose from a wide gamut of courses, as also to provide them lateral mobility between various educational institutions in the country where they can carry their acquired credits. I am happy to note that the university has been recently accredited by National Assessment and Accreditation Council of India (NAAC) with grade "A".

UGC (Open and Distance Learning Programmes and Online Programmes) Regulations, 2020 have mandated compliance with CBCS for U.G. programmes for all the HEIs in this mode. Welcoming this paradigm shift in higher education, Netaji Subhas Open University (NSOU) has resolved to adopt CBCS from the academic session 2021-22 at the Under Graduate Degree Programme level. The present syllabus, framed in the spirit of syllabi recommended by UGC, lays due stress on all aspects envisaged in the curricular framework of the apex body on higher education. It will be imparted to learners over the six semesters of the Programme.

Self Learning Materials (SLMs) are the mainstay of Student Support Services (SSS) of an Open University. From a logistic point of view, NSOU has embarked upon CBCS presently with SLMs in English / Bengali. Eventually, the English version SLMs will be translated into Bengali too, for the benefit of learners. As always, all of our teaching faculties contributed in this process. In addition to this we have also requisitioned the services of best academics in each domain in preparation of the new SLMs. I am sure they will be of commendable academic support. We look forward to proactive feedback from all stakeholders who will participate in the teaching-learning based on these study materials. It has been a very challenging task well executed, and I congratulate all concerned in the preparation of these SLMs.

I wish the venture a grand success.

Professor (Dr.) Subha Sankar Sarkar
Vice-Chancellor

Under Graduate Degree Programme

Choice Based Credit System (CBCS)

Subject : Honours in Botany (HBT)

Course : Biodiversity

(Microbes, Algae, Fungi and Archegoniate)

Course Code : GE-BT-11

First Print : July, 2021

Under Graduate Degree Programme

Choice Based Credit System (CBCS)

Subject : Honours in Botany (HBT)

Course : Biodiversity

(Microbes, Algae, Fungi and Archegoniate)

Course Code : GE-BT-11

: Board of Studies :

Members

Prof. Kajal De

(Chairperson)

Director, School of Sciences

NSOU

Prof. Nandadulal Paria

Professor of Botany

NSOU

Mr. Sandip Das

Assistant Professor of Botany

NSOU

Dr. Sushovan Bera

Associate Professor of Botany

Jogamaya Devi College

: Course Writer :

Dr. Pranab Giri

Associate Professor

Dum Dum Motijheel College

Prof. Sanjay Guha Roy

Professor of Botany

West Bengal State University

Dr. Shaymal Kumar Chakraborty

Retd. Associate Professor, WBES

Bidhannagar Govt. College

Dr. Swapan Bhattacharya

Retd. Associate Professor, WBES

Maulana Azad College

Prof. Alope Bhattacharjee

Professor of Botany

Burdwan University

: Course Editor :

Dr. Swapan Bhattacharyya

Retd. Associate Professor

Maulana Azad College

: Format Editors :

Mr. Sandip Das

Dr. Swapan Bhattacharyya

Notification

All rights reserved. No part of this study material may be reproduced in any form without permission in writing from Netaji Subhas Open University.

Kishore Sengupta

Registrar



**Netaji Subhas
Open University**

**UG-Botany
(HBT)**

Course : Biodiversity

Course Code : GE : BT – 11

Unit 1	☐	Microbes	07–70
Unit 2	☐	Algae	71–120
Unit 3	☐	Fungi	121–167
Unit 4	☐	Unifying characters of Archaeogoniatae	168–1174
Unit 5	☐	Bryophyta	175–195
Unit 6	☐	Pteridophyta	196–216
Unit 7	☐	Gymnosperm	217–260

Unit 1 □ **Microbes**

Structure

- 1.0 Objective**
- 1.1 Introduction**
- 1.2 Discovery of Viruses**
- 1.3 General Characteristics of viruses**
 - 1.3.1 Host Range**
 - 1.3.2 Shape and size of viruses**
- 1.4 Structure of Viruses**
 - 1.4.1 Structure of a typical helical plant virus**
 - 1.4.2 Structure of a typical Complex virus (bacteriophage)**
- 1.5 Classification of plant viruses on the basis of nucleic acid composition**
- 1.6 Multiplication of viruses**
 - 1.6.1 Lytic cycle**
 - 1.6.2 Lysogenic cycle**
- 1.7 Economic importance of viruses**
- 1.8 Bacteria**
- 1.9 General Characteristics of Bacteria**
 - 1.9.1 Shape and size**
 - 1.9.2 Bacterial Nutrition**
 - 1.9.3 Bacterial Growth**
 - 1.9.4 Metabolic characteristics**
 - 1.9.5 Bacterial genetic recombination**
 - 1.9.6 Bacterial sporulation**
 - 1.9.7 Structure of bacterial cell**
- 1.10 Economic importance of Bacteria**
- 1.11 Summary**
- 1.12 Exercises**

1.0 □ Objective

The microbes are almost omnipresent. They include viruses and bacteria. In this Unit you will become acquainted with their general characteristics and will be able to know how important they are in our lives as well as globally.

1.1 □ Introduction

Diversity is the gift of nature. In living world the diversity among organisms is known as biodiversity which includes microbial diversity. The microbial diversity consists of microscopic living objects like bacteria, algae, fungi etc. The viruses which are intermediate between living and non living objects also contribute to a great extent to the microbial diversity. The study of representatives of microbial diversity in details is very important since they play immense role in human welfare and sustainable development of environmental ecosystem. Not only that, by virtue of their some unique metabolic activities such microbial wealth could be exploited in the production of industrially important compounds which add values to our economy. In this unit, the history of discovery of two types of microbes such as bacteria and viruses has been highlighted. The structural characteristics of such two groups and their economic values have been discussed in detail. After going through this unit learners would be able to understand the background of researches related to their discovery. They would understand the structural peculiarities of such two kinds of microbes which are different from higher plants and animals. They would acquire some knowledge regarding the application of such microbes in different fields of environment, industry and welfare of human beings.

1.2 □ Discovery of Viruses

There is a long history behind the discovery of virus particle and the progress in the study of viruses i.e. virology. The onset of the science began in 1774 when Benjamin Jesty, a farmer had vaccinated his wife and two sons with cowpox taken from the udder of an infected cow and had written down his experiences. Using such written accounts Edward Jenner in 1776 used cowpox to elicit immune response against smallpox. In 1885, Louis Pasteur discovered rabies vaccination and he was the pioneer worker who coined the terms 'virus' and 'vaccination'. He actually developed the scientific basis for Jenner's experimental approach to vaccination. The stepping stone towards the discovery of virus

was the discovery of porcelain bacterial filter by Charls Chamberland in 1884. Such filter was used to sterilize liquid. In his experimental study, A. Mayer (1886) showed that the sap of mosaic leaves of tobacco when inoculated to the healthy plant it develops the characteristic symptoms. He concluded that the sap contains bacteria as inoculum, which was responsible for development of disease symptoms.

Russian Botanist Dmitri Ivanovski in 1892 for the first time filtered the sap of infected tobacco plant by using Chamberland filter designed to separate bacteria. He observed that the filtered sap was capable of developing mosaic symptoms after injection to the healthy host. He concluded that the infectious agent was bacteria which were smaller than usual bacteria and hence filterable. Such inoculum was named as virus i.e. poisonous fluid. The concept of virus as small and infectious particle which can readily pass through porcelain filter came into depiction in 1898. Professor Martinus W. Beijerinck at the Technical University of Netherland had put forth the concept and defined the infectious agent as *contagium vivum fluidum*. He also observed that the infectious agents are smaller than bacteria and could diffuse through the agar that arrested bacteria. Moreover his experimental results revealed that the virus could not be cultured without the living host cells. The virus was *Tobacco mosaic virus* (TMV). Actually, Beijerinck was the first person who reported that microbes need not be cellular. In the same year two German Scientist Loeffler and Frosch used porcelain filter for the isolation of the causal agent of foot and mouth disease of cattle.

F.W. Twort (1915) in England demonstrated that the bacterial colony could be lysed by some agents and the lysate is transmitted from colony to colony. The diluted sample of bacterial lysate can pass through the bacterial filter and when such lysate is used to infect fresh bacterial colony, the lytic effect was demonstrated. Upon heating the lysate loses its ability to cause lysis of the bacterial colony. Twort suggested that the lysis was caused by virus. Felix d' Herelle in Pasteur Research Institute rediscovered the phenomenon and coined the term bacteriophage i.e. bacteria eater to these bacteria infecting agents.

Two major technical breakthroughs took place by the end of third decade of 20th century. One is the development of ultracentrifugation technique and the other is the discovery of electron microscopy. With the advent of such two techniques it was not possible to resolve many unsettled issues related to discovery of virus particle. The developments of viral research after that are summarized below:

- a) In the year 1935, American Chemist Wendell M. Stanley crystallized the Tobacco mosaic virus from tobacco leaves and showed that when such crystals are inoculated to healthy plants the infectivity is retained. Stanley was awarded the Nobel Prize in 1946 for this work.
- b) In the year 1938, two British Biochemists F.C. Bawden and N.W. Pirie through detailed analysis demonstrated that the crystals of TMV are made up of protein and ribonucleic acid (RNA) and won Nobel Prize.
- c) In 1952, Hershey and Chase studied the structure of T₂ bacteriophage in detail with the help of electron microscope and proved that DNA was the genetic material of T₂ bacteriophage. Such DNA phage passes its genome to the living cell to cause infection.
- d) In 1956, the RNA was proved to be an infectious agent and genetic material by Gierrer and Schramm. They also demonstrated experimentally the virus uses nitrogenous and other compounds for replication of its own genome. Fraenkel-Conrat confirmed that RNA is the genetic material of TMV. Thus it took more or less 50 years to prove that TMV was an infectious nucleoprotein and since then it has continued to play leading role in the development of fundamental concept of virology. Between 1960 and 1970, many researches at the molecular level were performed related to the understanding of the virus encoded proteins using TMV.
- e) In 1963, cyanophages, the viruses eating upon the members of Cyanophyceae or Blue Green Algae (BGA) were discovered by Safferman and Morris.
- f) In 1966, satellite virus was discovered by Kassanis.
- g) In 1967, capsidless or naked infectious genetic material or viroid was discovered by Diener and Raymer.
- h) Mycovirus from the cultivated button mushroom was discovered by Hollings in 1982. In the same year, proteinaceous infectious particle called Prion was discovered by Prusiner.
- i) In 1983, Luc Montagnier discovered HIV.

During last few decades much advancement has taken place in virology. Techniques for isolation and artificial cultivation of viruses have been developed. Now a days viruses

are being used in the preparation of genetic maps, immunization process, genetic engineering, molecular biology, vaccine development etc.

1.3 □ General Characteristics of viruses

The answer will be ambiguous if question arises whether viruses are living or nonliving objects. Life is a complex set of processes governed by nucleic acid derived proteins. Since viruses are inert outside the living cell they are not considered to be living entities. When it infects the host cell, its nucleic acid or genome replicates and proteins are synthesized to form progeny particles. Thus virus could be defined as a simple, small, filterable, exceptional living organism with complex aggregation of non living chemicals which requires living host for multiplication. Lwoff (1957) defined that “*Viruses are infectious, potentially pathogenic nucleoprotein with only one type o nucleic acid which reproduce from their genetic material are unable to grow and divide and devoid of enzymes*”. Lwoff and Tournier (1962) set apart viruses from other organisms on the basis of following eatures:

- i) They are all potentially infectious
- ii) Presence of single nucleic acid.
- iii) Absence of enzymes or energy metabolism.
- iv) Absence of ribosome.
- v) Absence of information for the synthesis o ribosomal RNA and soluble tRNA.
- vi) Incapability to grow the genetic material only.
- vii) Reproduction from genetic material only.
- viii) Absence of information for the production n of enzymes in the energy cycle.
- ix) Absence of information for the synthesis of ribosomal proteins.

Viruses are devoid of their own metabolic enzymes and enzymes for proteins and ATP synthesis. They need host metabolic machinery for multiplication. This unique property is counteractive for the development of antiviral drug, because any compound which has preventive role for viral multiplication would also interfere with the functioning of the host cell and therefore are toxic for clinical use.

1.3.1 Host Range

Viruses are host specific and may infect a wide range of host and causing damage to the host. The host range includes invertebrates, vertebrates, plants, fungi, bacteria, algae etc. However, host specificity is a constant feature except some specific cases. The phenomenon of host specificity could be explained by the existence of some unique types of receptor and antigenic interaction. Viral antigen has some specific molecules on their structure by which it can bind with compatible receptor molecules present on the host cell surface. Different forces such as hydrogen bond Van-dar Wall forces, electrostatic interaction between virus and host in addition, are also responsible for stable association between virus and host which is required for successful infection. Sometimes fimbriae, flagella on bacterial surface serve as binding components between virus and host.

The specificity of binding between virus and host might have some therapeutic significance. The specificity of bacteriophages to kill bacterial cells might be a possible field of exploration for preparation of antibacterial vaccine by which pathogenic bacteria could be killed with the preparation of a specific strain of virus. This strategy has now been popularised as *phage therapy*. With the advancement of scientific technology special effort is now being given on research to develop specific viral strain which could destroy oncogenic cell- line by lysis. Development of effective oncolytic viral strain with a biotechnological approach and its successful application on the patient suffering from cancer is a challenging area of virological research in present day context.

1.3.2 Shape and size of viruses

The shape and size of the viruses are variable. As determined by electron microscopy the size of viruses could range from 20 to 1000nm. Usually the size of viruses are smaller than bacteria but rarely some large viruses have sizes identical to the size of some smaller bacteria like mycoplasma, rickettsias and chlamydias (e.g. vaccinia virus). Virus of lymphogranuloma is slightly larger than the smallest bacterium (3000-400µm). The shape of different viruses may be as follows:

Shape of the virus	Example
1. Spheroid or cuboids	Adenoviruses
2. Elongated viruses	Potato viruses
3. Flexuous or coiled	Beet yellow virus
4. Bullet shaped	Rabies virus, Nuclear Polyhedrosis Virus(NPV)
5. Pleomorphic	Alfa alfa mosaic virus
6. Filamentous	Bacteriophage M13.
7. Brick shaped	Pox virus

1.4 □ Structure of viruses

A complete virus is known as virion. The virion is basically nucleo-proteinaceous in nature. It has a central core of nucleic acid surrounding which proteinaceous coat called capsid is present. So virus is a nucleocapsid particle. Capsid is made up of structural unit called capsomere which is made up of polypeptide chains. The protein in the capsid is known as capsomere or capsomers. The helical capsid contains single type of structural protein whereas icosahedral capsid is made up of several types of structural proteins.

In some viruses, surrounding the capsid, a covering is present called envelope and viruses having such envelope are called enveloped virion. Chemically the envelope is made up of proteins and glycoproteins and sometimes due to the presence of lipid the envelope becomes loose and flexible. Envelope may be made up of host specific carbohydrate component and virus specific protein components. In several viruses the envelope is made up of lipid bilayer which is inert and acts as a protective layer to prevent desiccation or enzymatic degradation of virus particle. The constituent lipids may be of three types such as glycolipid, phospholipid and cholesterol. On the surface of envelope in some viruses, certain projections are found which are called spikes. Such spikes are glycoprotein in nature. Usually enveloped viruses are animal viruses as the envelope is acquired from the host cell membrane. It is a true double layered membrane with modifications by the way of spikes etc.

On the basis of electron microscopic and crystallographic analysis viruses could be categorised into three broad morphological groups such as a) Helical or cylindrical viruses b) Polyhedral viruses and c) Complex viruses.

- a) **Helical Viruses:** The capsid of these viruses is rod shaped, elongated, hollow, and cylindrical and the capsomers of the capsid are helically arranged. In TMV the helical capsid is naked whereas in influenza virus the capsid is enveloped.

1.4.1 Structure of a typical helical plant virus

Tobacco Mosaic Virus or TMV is a typical example of a helical virion. It is a rod shaped elongated particle. The length of each particle is 300nm and diameter is 15nm. There are 2130 capsomers in each rod. The centre of the rod is occupied by RNA helix, surrounding which the capsomers are arranged in a helical array. There is a hollow core at the centre of each rod which is about 4 nm in diameter. It runs along the entire length of the rod. The RNA molecule is deeply embedded in the core and remains associated with the protein subunits. RNA is a single stranded molecule which also runs along the entire length of the rod. The protein content of the particle is about 95% and remaining portion (5%) is occupied by RNA. The proteins in the capsid are of high molecular weight of about 40 million Dalton whereas the single stranded RNA has the molecular weight of 2 million Dalton. The ss (+) RNA of the virus is made up of 6500 nucleotides. It is called + or sense because it can act as m RNA. In each helical turn there are about 16 and 1/3 protein subunits and three turn of the helix contain about 49 capsomers. Each capsomer has a molecular weight of about 17300 dalton and arranged in the virus with a pitch of 23\AA . The amino acid composition of the capsomer is similar to the amino acid composition of other plant proteins. Each capsomer contains about 168 amino acid molecules. Stanley (1935) for the first time isolated TMV in the form of crystal from the leaf sap of infected tobacco plant. The virion may remain infective for about 50 years and it can withstand boiling for about 10 minutes. (Fig. 1.1)

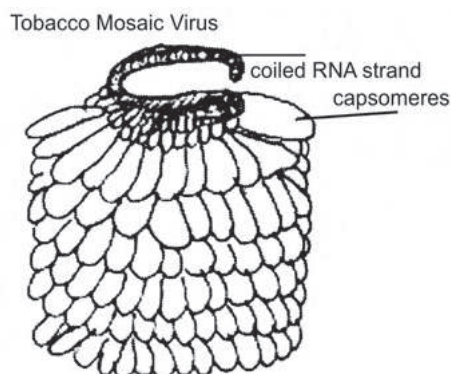

Fig. 1.1 : Structure of a TMV

- b) Polyhedral viruses:** Three symmetries of the polyhedral particle may be possible such as tetrahedral, octahedral and icosahedral. An icosahedron is a regular polyhedron type with 20 triangular faces, 30 edges and 12 vertices. The polyhedral viruses may be naked (i.e. without any envelope surrounding the capsid e.g. adenovirus, poliovirus etc.) or enveloped (i.e. with envelope surrounding the capsid e.g. herpes simplex virus etc.).
- c) Complex Viruses:** Complex viruses may have capsid which are neither helical nor polyhedral. Where capsid is present, it remains associated with some additional structures. Vaccinia virus is an example of complex virus where the virion is brick shaped. Capsid with additional tail like structure is found in T even series of phages which look like tadpole. T_4 bacteriophage is a complex virus of binal type where head is polyhedral and tail is helical.

1.4.2 Structure of a typical Complex virus (Bacteriophage T_2)

Bacteriophage is a typical DNA virus which is differentiated into three parts such as head, collar or neck and tail. It is a naked virion with contractile tail. Since the virion has both an icosahedral head and a hollow helical tail, it is said to have a binal symmetry. The different parts of this virus are described below:

Head: The head of the bacteriophage is icosahedral. The size of the head is 95x65 nm. It consists of about 2000 capsomer subunits. A double stranded DNA molecule is tightly packed inside the head. The length of the DNA is 1000 times greater than the length of the phage itself. It is linear and terminally redundant. The bacteriophage DNA has 5-hydroxymethylated cytosine instead of normal cytosine nucleotide base. In this respect bacteriophage DNA differs from the normal DNA. On entering the host cell the DNA gets circularized by annealing of terminal cos sites.

Neck: The phage head and its long helical tail remains connected by a small connector called neck. The neck has a collar and to which multiple whiskers remain attached.

Tail : The size of the tail of bacteriophage is 80x18 nm. It has a central hollow tubular core (Diameter 25A⁰). The central core is surrounded by a contractile sheath. The sheath is made up of 24 rings, each containing 6 subunits. Thus total 144 protein subunits aggregated together to form the contractile sheath. The sheath connects head at one end and base plate at the other end. On contraction the tail exposes the central hollow tubular cylinder which penetrates the bacterial cell wall.

At the end of the tail fibre there is a hexagonal base plate. Six spikes remain attached to the six corners of the base plate. The spikes are 130x2 nm in size. Spikes help in the attachment of phage with the specific receptor of the host surface. Each spike is differentiated into a proximal part which remains attached firmly with the base plate and a distal part which recognizes the specific receptor site of the host surface. Thus the spikes in bacteriophage have significant role in causing host infection. **(Fig. 1.2)**

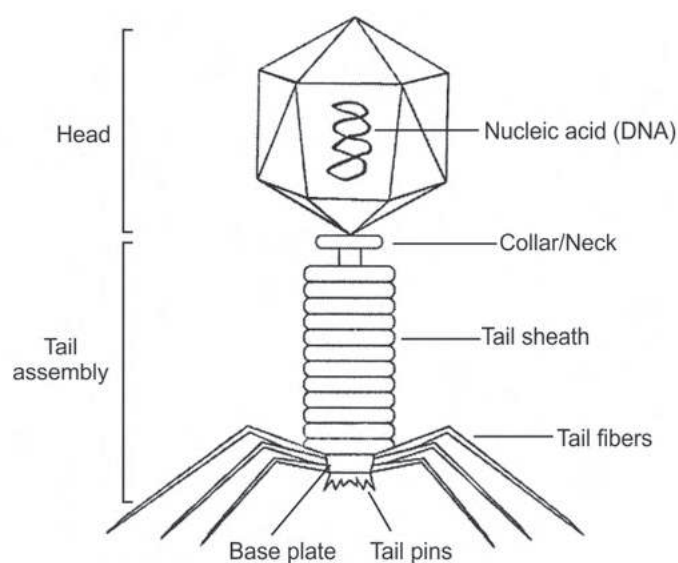

Fig. 1.2 : Structure of a Bacteriophage

1.5 □ Classification of plant viruses on the basis of nucleic acid composition

All viruses belong to the kingdom viruses. Broadly, the plant viruses have been categorised into RNA viruses and DNA viruses. They have either DNA or RNA as genome. DNA can be single (ss) or double stranded (ds). RNA can also be ss or ds type and genomic RNA can either act as mRNA (+ or sense type) or unable to do so (- or antisense type). The classification of Viruses is outlined in the Table-1. (See next page)

1.6 □ Multiplication of viruses

Viral multiplication was best studied in bacteriophages. There are two modes of multiplication of phages. One is lytic and other is lysogenic mode of multiplication. The

viruses which multiply by lytic mode are called virulent phages and those which exhibit lysogenic cycle are called temperate phages. Different stages of multiplication cycle of two types of phages are described below:

1.6.1 Lytic cycle

This type of multiplication cycle is found in T even series (T₂, T₄ etc.) of phages such as T₄ phage. The lytic cycles is accomplished by the following stages:

- a) **Adsorption:** The attachment of phage particle on the host cell surface is known as adsorption. It is a surface specific phenomenon in which interaction between host surface receptor and phage occurs. The receptor of host surface may be different chemical molecules or surface structures. The process of adsorption involves complementary interaction between surface receptor and phage particle. In bacteria lipopolysaccharide may serve as receptor. Besides, any kind of surface molecules such as carbohydrate, protein etc. may function as receptor to which specific phage particle can bind. Different surface structure like pili, fimbriae, etc. may play significant role in the process of adsorption. In case of phage, the attachment of phage on host bacterium takes place with the help of tail fibre. Such attachment may be reversed as the virus could be washed off by any possible means from the surface until and unless the tail pins present on the base plate of tail fibre attach themselves on the surface of the cell.
- b) **Penetration:** It is the process by which genetic materials of phage enter into the host cell. In case of bacteriophage the proteins present in the base plate of the tail fibre have lysozyme activity. The proteins having lysozyme activity acts on the peptidoglycan of bacterial cell wall and digest it. Peptidoglycan polymer has alternately arranged repeating unit of N- acetylc glucosamine (NAGA) and N-acetylc muramic acid (NAMA), linked with each other by β -1,4 glycosidic linkage. Phage lysozyme attacks such linkage and cleaves it to dissolve the hard layer of peptidoglycan locally. The contractile sheath present in the tail fibre plays a significant role in the process of penetration. It contracts and pushes the core tube of the tail fibre to penetrate through wall layer just like a syringe injects a vaccine (**Fig. 1.3**). Penetration in T₂, T₄ phages is therefore partly mechanical and partly enzymatic process. The injection tube, however, penetrates the peptidoglycan but never penetrates the cytoplasmic membrane. The genetic material from the phage head thus passes through the core tube and reaches the periplasmic space above cytoplasm of the host bacterium leaving the protein

Table 1 : General outline of Classification of Viruses

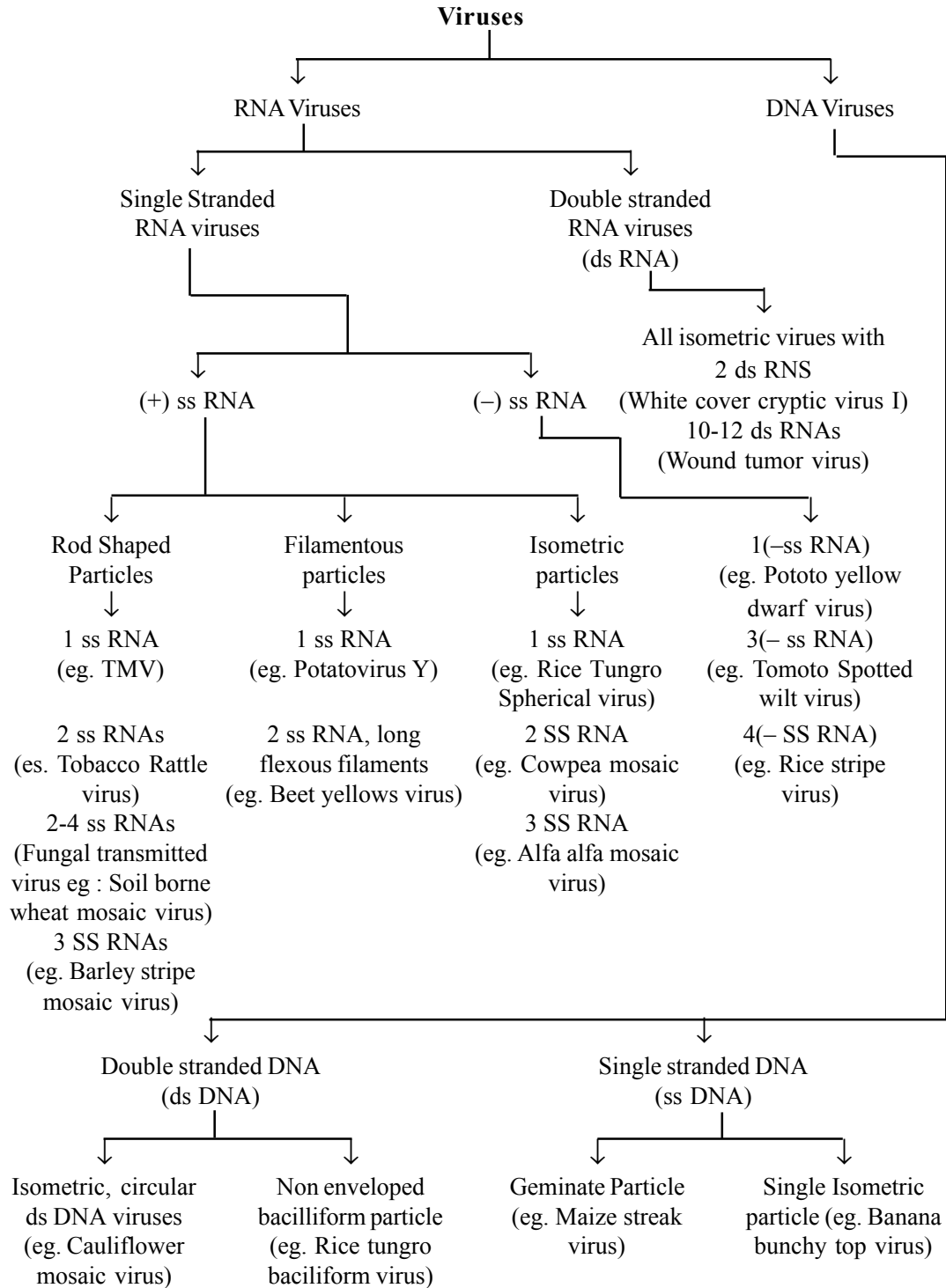

coat of the phage particle outside the cell, commonly called ghost. Sheath contraction may not be a prerequisite for phage infection in many cases like T1, T5 phages where such sheath is absent and the phage penetrates their nucleic acid through cell envelope possibly at adhesion site between the inner and outer membrane. Sometimes the virion enters the host cell prior to the liberation of DNA from capsid (e.g. fd and M13).

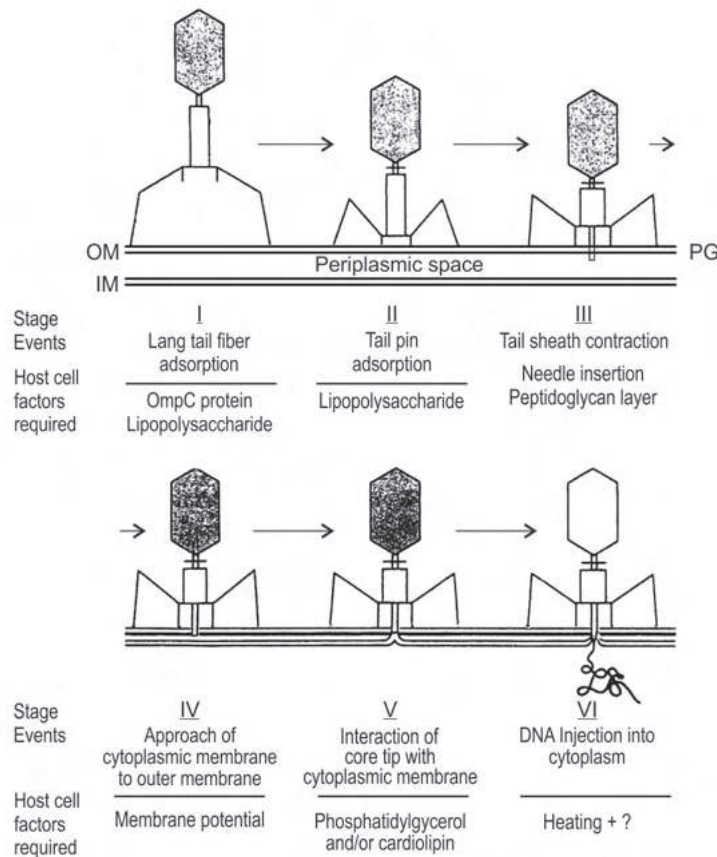

Fig. 1.3 : Summary of process of phage T4 infection. OM, outer membrane; IM, inner membrane; PG, peptidoglycan layer. [Reproduced from H. Furukawa, T. Kuroiwa, and S. Mizushima, “DNA Injection During Bacteriophage T4 Infection of *Escherichia coli*,” *J. Bacteriol.* **154** : 938–945, 1983, Courtesy of S. Mizushima, Nagoya University.]

- c) **Replication & transcription:** After entry of the viral genome into the host cell the process of gene expression of host cell is stopped. In case of T4 phage the phage genome contains three classes of genes such as immediate early gene, delayed early gene and late gene. The genes are named after the sequence of their expression inside the host cell.

At first, immediate early genes express with the help of host cell's protein synthesis machinery. The proteins encoded by immediate early gene cleave the host cell genome into nucleotide subunits. The product of the genes also modifies the RNA polymerase in such a manner that the modified RNA polymerase could initiate the transcription of delayed early genes. The cleavage of the host genome is essential to supply nucleotide subunits required for phage genome replication or synthesis that means the free nucleotides generated after host genome cleavage are utilized for the phage genome replication. All the nucleotides of the host genome could be utilized for phage genome synthesis except cytosine. The latter becomes incorporated into the phage genome after being modified into 5- hydroxymethyle cytosine. So the cytosine of the phage genome is hydroxymethylated derivative. This modification is performed by delayed early genes. The product of such genes glucosylate the cytosine residue inside the cytoplasm of the host cell in such a manner that the normal cytosine could not be incorporated during synthesis of phage genome. Not only that, the gene product modifies RNA polymerase again in a manner so that it could sequentially initiate late genes. The late gene products are different structural components of progeny phage (head, neck, tail fibres etc.). Late gene product also has lysozyme activity and therefore it causes lysis of the host cell to release progeny virions. This is the general T₄ model of replication and transcription of viral genome. The sequence of transcription events of phage DNA in other bacteriophages may vary to some extent.

There are two models for replication of DNA of T₄ phage inside the host cell *E.coli*. Early replication takes place by θ (theta) mode which requires a bidirectional replication fork to be formed. Late phage replication takes place by 'Rolling Circle' mechanism where the outer strand is nicked and drawn away as a single stranded template. Interestingly, T₄ DNA on replication produces 3-4 daughter DNA molecules which are end ligated known as concatamer.

Assembly and release: The process of aggregation of structural components of phage particle is known as assembly. It starts after the viral components are being synthesized completely. About 25 mins after initial infection nearly 200-300 progeny phages get assembled and the bacterial cell bursts, releasing the new phages. The yield of phage per bacterium is called burst size. **(Fig. 1.4)**

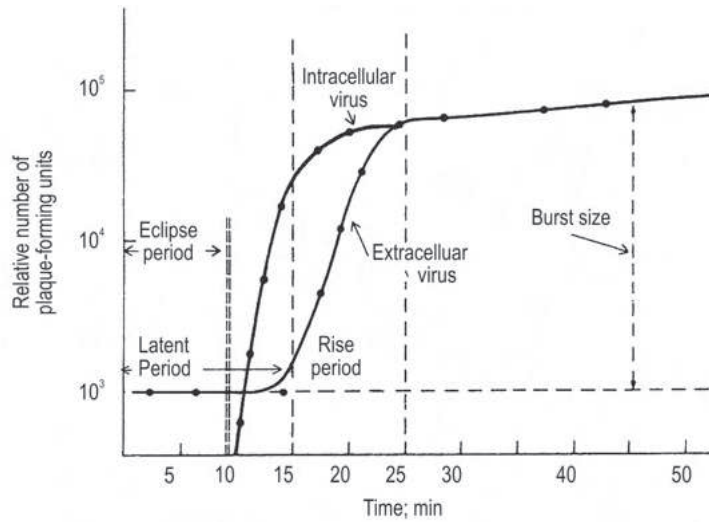

Fig. 1.4 : One step growth curve of lytic phage showing burst size.

Specifically during first 10 mins of phage infection no phage can be recovered by disrupting the infected bacterium. This phase is known as eclipse period. At the end of this period matured phages begin to accumulate intracellularly until they are released by cell lysis. The time interval between the infections until lysis is known as latent period. After that the number of extracellular phages increase until it reaches a constant titer at the end of the multiplication cycle; this time period is known as rise period.(**Fig. 1.5**).

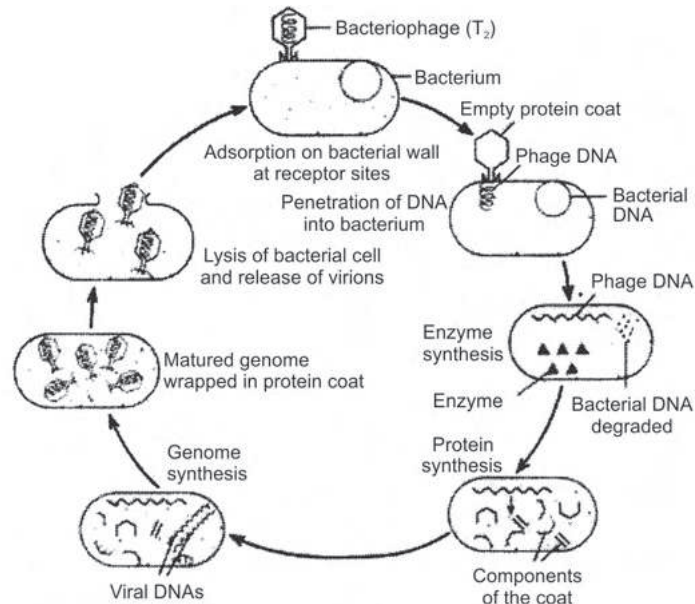

Fig. 1.5 : Lytic life cycle of bacteriophage (T_2)

1.6.2 Lysogenic Cycle of Bacteriophage λ (lambda)

In lysogenic phage or temperate phage the processes phenomenon of adsorption, penetration are similar to that of lytic phage, but there is a precise genetic regulation by which phage genome integrates with the host genome to form a dormant structure called prophage.

Mechanism of entry of phage into lysogeny: In lambda phage, the DNA after entry inside the host cell becomes circularised. Out of three classes of genes present on the genome, expression of immediate early genes (CRO & N) and late genes (O, P, Q, S, R etc.) are suppressed by an intricate gene regulatory mechanism which helps the lysogeny to set in. This suppression is brought about by repressor molecules coded by cI gene. The repressor synthesis is initially started with the help of promoter P^E under the control of cII and cIII. The promoter P^E is located between cro and cII gene. The product of gene cII and cIII acts on promoter P^E , so that the RNA polymerase enzyme can initiate transcription towards left, thus synthesizing RNA of genes cro and cI. The anticlockwise transcript of cro gene could not translate into protein but the anticlockwise transcript of cI gene can do so and produce repressor protein. Such repressor binds with the promoter and operator of cro and N gene (PR/OR & PL/OL respectively) and inhibits their expression (**Fig. 1.6**). After initiating P^E promoter driven synthesis of repressor by cI gene,

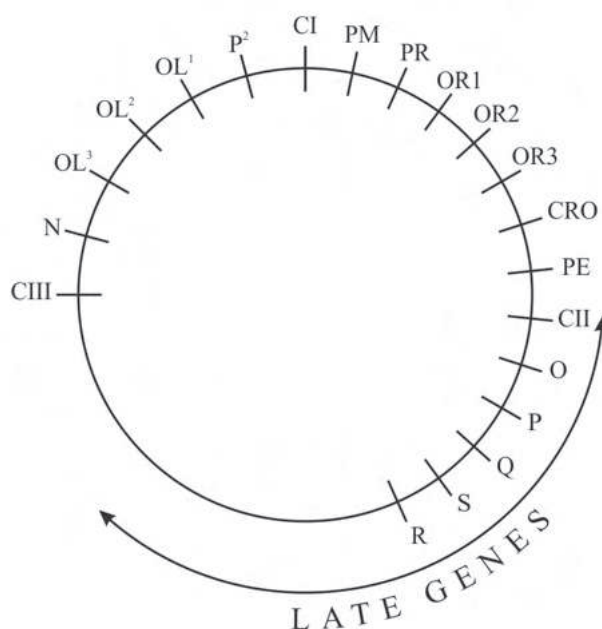

Fig. 1.6 : Map of λ (lambda) phage genome

cII and *cIII* genes are switched off but another promoter P^M located in between *cro* and *cI* gene is activated and allows the *cI* repressor to be synthesized in limited amount. Thus limited repressor concentration under the control of P^M is more important for inhibition of the expression of immediate early and late genes. This helps the phage to enter and maintain lysogeny.

Mechanism of prophage formation: The integration of phage genome with bacterial genome leads to the formation of prophage. The mechanism of prophage formation is

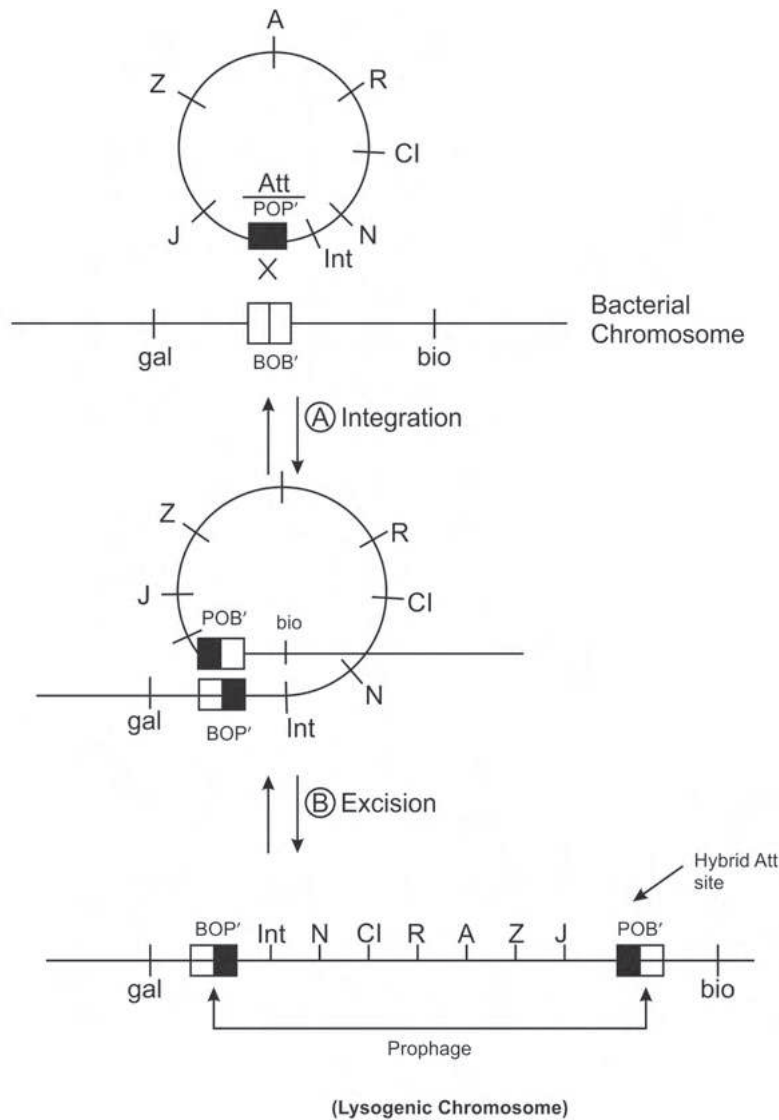

Fig. 1.7 : Molecular mechanism of prophage formation and induction.

basically a phenomenon of genetic recombination with site specificity. The specific site of phage and bacterial genome which takes part in the recombination is designated as att P and att B site respectively. In *E. coli* the att B site is located between two marker genes such as **gal** (galactose) and **bio** (biotin). In lambda phage the location of attP site is demarcated between two marker genes of the genome such as *Int* and *J*. An endonucleolytic cleavage occurs within such two sites at the same base location. The *Int* gene of lambda phage DNA produces an enzyme called integrase which with the help of special bacterial protein catalyses the physical exchange of viral and bacterial DNA strand. The circular phage DNA is integrated into the bacterial chromosome as linear DNA between **gal** and **bio** genes, and is called prophage. (Fig. 1.7).

Mechanism of Phage Induction: When host bacterial cell becomes stressed, the phage genome gets separated from the prophage and enters into normal lytic mode of reproduction as discussed in the lytic cycle. The mechanism of excision of phage genome from the integrated state is catalysed by an enzyme. The initiation of induction process is associated with sudden fall in the level of repressor molecules. The operator OR and OL has three binding sites such as OR1-OR2-OR3 and OL1-OL2-OL3 respectively. The sites are gradually occupied by the repressor molecules synthesised by *cI* gene under the control of promoter *pM*. Since the promoter *pM* lies in the site 3 the occurrence of repressor at that site inhibit *pM* and the repressor level gradually falls because now *cI* gene cannot synthesize repressor molecules by the promoter *PM*. Moreover the cleavage of repressor molecules occurs. The repressor molecule has a N terminal and a C terminal domain. Two such domains are connected by a connector region made up of 93-132 amino acid residues. In a stressed host cell this connector is cleaved by enzyme Rec A Protease. Due to cleavage in the connector region first C terminal domain is released and N- terminal domain loses its affinity to bind with operator.(Figs. 1.8 i&ii) Now the genes repressed earlier by the repressors will be expressed causing the entry of phage into lytic phase. The process of replication, structural protein synthesis and assembly to for progeny particles are more or less similar to lytic phage. [Fig. 1.8(iii)]

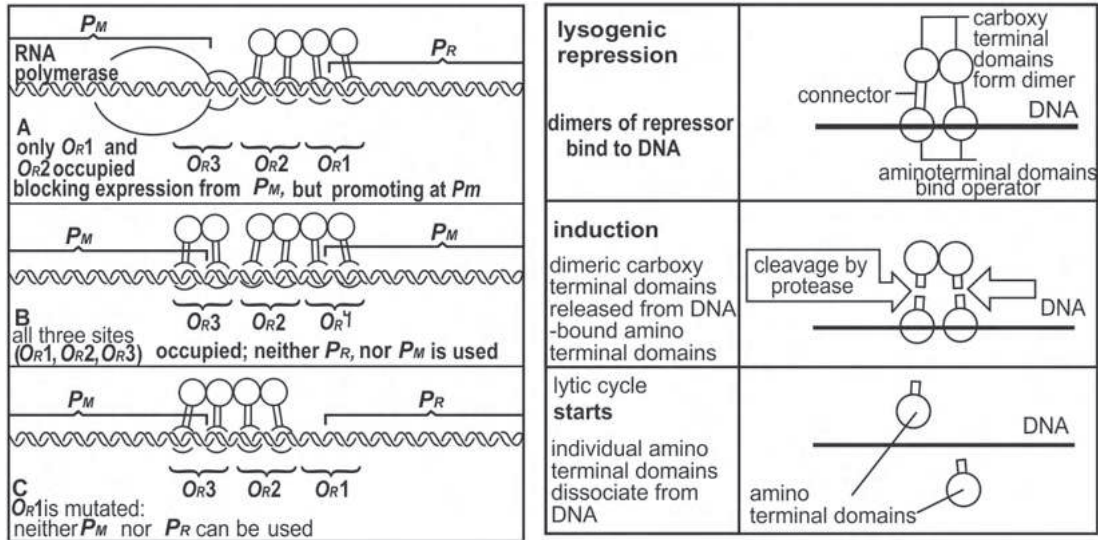

Fig. 1.8(i) : The role of three parts of O_R in autogenous regulation of repressor synthesis (for details see text)

Fig. 1.8(ii) : The role of C-terminal domains in controlling the binding of repressor dimers to the operator site (through the N-terminal domain of repressor). (Note that due to cleavage of C-terminal domains, the N-terminal domains lose their affinity for binding).

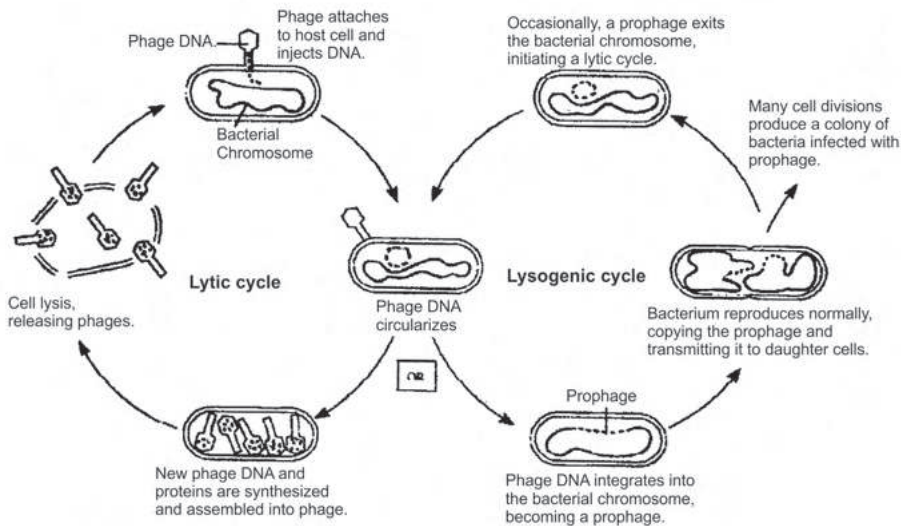

Fig. 1.8(iii) : Lysogenic cycle in λ phage

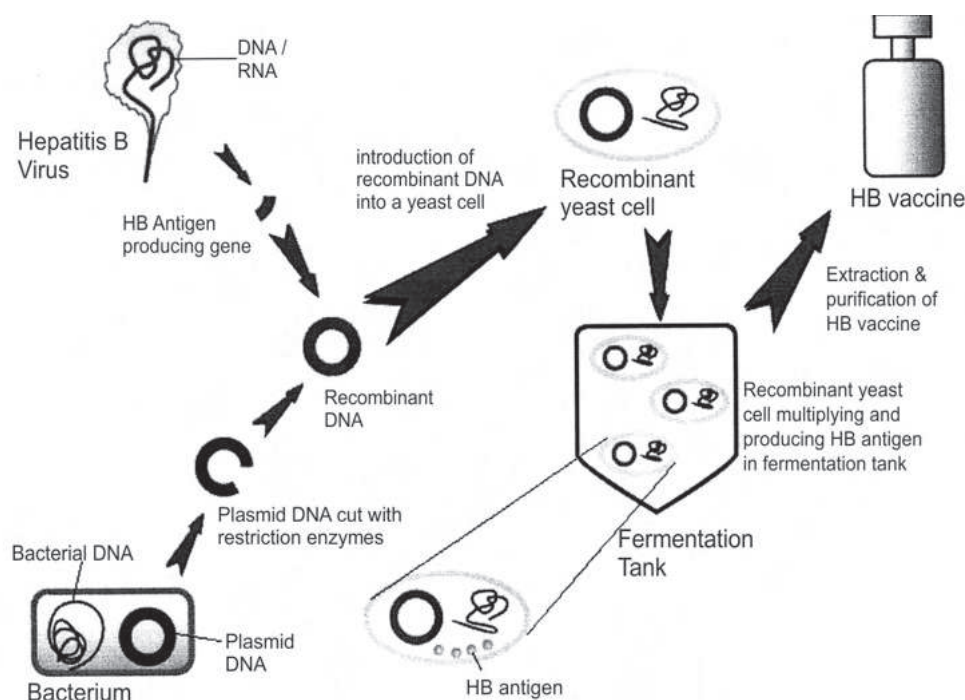

Fig. 1.8(iv) : Production of Recombinant HB Vaccine

1.7 □ Economic importance of viruses

Viruses are infectious particles which cause infection to plants, animals, humans, fungi etc. Human efforts have made viruses useful in many ways. Viruses could be exploited in genetic engineering, pesticide production, vaccine production, medicines and many other ways. The different fields of application of viruses are :

- a) **Role of virus in vaccine production:** Viruses play a significant role in the production of life-saving vaccines. The use of viruses as vaccines was started by Edward Jenner in 1796. He used cowpox or vaccinia virus as a live vaccine to prevent smallpox. Conventional vaccines are produced using live attenuated virulent strains which are easy to produce and confer resistance to the same pathogenic viruses. It involves production of a viral strain which is pathogenic for a particular disease under cultured conditions in a controlled environment. Use of sophisticated fermentation technology, tissue culture techniques could be used for production of viruses at an effective rate. After production, viruses are separated from the culture environment through graded ultrafiltration and after attenuation, such virulent strains of viruses could be used as vaccines. Use of such live attenuated

virus or killed viruses have some disadvantages, such as; i) The attenuated strain sometimes become virulent, e.g. live Poliovaccine. ii) Since viruses are grown in animal cells some undesirable, undefined components may be mixed up. iii) Some viruses are difficult to produce since they don't grow in culture medium, e.g. Hepatitis B virus iv) Inactivated viral vaccine sometimes may be ineffective in some diseases.

Nowadays to overcome such difficulties recombinant viral vaccines are used. The production of such vaccine involves isolation and purification of gene coding for major antigenic protein of virus. Such gene is inserted into a suitable vector. **[Fig. 1.8 (iv)]** Avirulent viruses or bacteria may serve as vector for such genes. Now the recombinant viruses are incorporated into the human host. The gene replicates inside the host and express itself to produce recombinant proteins which provokes cell mediated or humoral immune response. Different viruses could be used as vector for such vaccine production such as Vaccinia virus, adenovirus, Canarypox virus, attenuated polio virus etc. Among these viruses Vaccinia virus is the most suitable one, since it has a broad host range and it can remain stable for a long period of time. However, the major drawback of this virus is its large size and lack of unique restriction site. So fusion of gene could be possible only through homologous recombination. The major antigenic proteins that could be expressed by such recombinant viruses are Hepatitis B surface antigen, haemagglutinin proteins, Rabies G proteins, Herpes simplex viral glycoproteins etc. It is also possible to clone 2-3 antigenic protein genes simultaneously in a given virus which opens up the possibility of vaccination with multiple antigens at one go.

Recently, DNA viruses are being used in the production of vaccines called DNA vaccines. However, DNA vaccine production is still in infancy and research is underway. A plasmid preparation with genes of pathogenic virus and a strong viral promoter is injected into the muscle of human host. Antigenic proteins of pathogens are produced in the muscle cells provoking cellular and humoral immune response. DNA vaccines against Hepatitis B virus, Herpes virus, AIDS virus have been developed and tested.

- b) Role of viruses in gene therapy:** The introduction of functional gene in human cell to correct defective gene by replacing them is known as gene therapy. Initially this technique was used to treat genetic disorders, now it is being used widely to treat different diseases like cancer and some infectious diseases. Viruses

have been proved to be useful carrier of desired genes. Gene therapy has been proved effective where a single gene or a limited number of genes are required to be corrected for a given disease. The success of gene therapy involves the availability of the functional copy of defective gene called therapeutic gene and efficient gene delivery system. Viruses serve as efficient gene delivery system for both ex vivo and in vivo gene therapy in use. Adenovirus, Adeno associated virus, Retrovirus, Vaccinia virus, Pox virus, Herpes simplex virus and others are used as efficient gene delivery system. Adenovirus is the most plausible candidate for gene therapy because of its high specificity, easy manipulation, effective nuclear invasion and high tendency of expression. Adenovirus is now being used in the treatment of respiratory disorder because of its high affinity to the cells of respiratory system. It is also used in the treatment of cystic fibrosis. However, major drawback is some adenovirus may be cytotoxic and have a narrow host range. Recently the concept of germ line gene therapy has come up which includes introduction of therapeutic gene in germ cell with the aim to correct defective gene in the next generation. This technique however is still not in use for human beings and restricted in laboratory.

- c) **Viral vaccine in cancer therapy:** Cancer is the uncontrolled proliferation of cells. A viral vaccine known as Hepatitis B vaccine is now commercially available for the treatment of liver cancer or hepatic cancer. Similarly, human papilloma virus is responsible for treating cervical cancer. Viral vaccines used to treat carcinogenic cell lines are prophylactic in nature. It stimulates the immune system to synthesize and to recruit specific antiviral molecules called interferon in cells. Cancer cells express characteristic viral specific proteins. Genes producing such proteins could be targeted using vector to enhance the specificity of vaccine. Such therapeutic vaccines are now in clinical trial and are still not approved for human beings. **Virus directed enzyme pro drug therapy (VDEPT)** is another approach for cancer treatment in which virus directed enzyme is targeted into the cancer cell. The enzyme can alter an inactive precursor of a cytotoxic drug into an active form. However the treatment model is in research stage and being evaluated for therapeutic effect.
- d) **Role of viruses in control of insect and pests:** Viruses can be used to control the harmful insects and pests. Nuclear polyhedrosis virus (NPV) is very important in this regard. This virus is used for the production of biopesticide. T2 phage is another important virus because it controls dysentery of human beings

by killing the pathogenic strains of *E. Coli* . This phage can be effectively used to purify water by virtue of its ability to eradicate coliform contaminants.

- e) **Role of virus in genetic research:** Viruses are used as simple models of living organism in laboratory for genetic research. In genetic engineering viruses are used in the identification of gene segments, exons, introns and for transfer of genes from one cell to another.
- f) **Role of viruses in evolutionary study:** Viruses play wider role to acquire knowledge about the trend of evolution and process of origin of living organisms. Viral DNA structures have proved more ways to get evidence of evolution. Apart from some viruses, all organisms use the same basic genetic code. This supports the evidence that everything is related and has evolved from a common ancestor. Viruses lie inbetween living and non- living entities which is very significant in tracing the evolutionary pathways.
- g) **Use of viruses in paints and burnishes:** Good quality of paints and burnishes available in the market contain virus particles as their important component. Such virus particles increase the shelf life of paints and burnishes. Not only that presence of virus particles helped to protect the timber, wooden furniture from the attack of fungi, bacteria, termites etc.
- h) **Use of virus in textile industry:** In textile industry viruses are also used. High quality textiles which are available in market contain virus particles. Such textiles have high polishes and are ten times more durable than normal ones.
- i) **Use of viruses in wood polishes:** Polishing of wood is a common practice to increase its glaze. A good quality polishing agent contains viral particles that serve as antifungal antibacterial and insecticidal agent. Using such a good quality of polishes having viral particle it could be possible to enhance the longevity and shine of wood.
- j) **Role of virus in disease diagnosis:** Viruses are responsible for different types of CNS (central nervous system) diseases. Two major clinical presentations are Aseptic meningitis and less common Meningo Encephalitis. Such diseases could be diagnosed with the help of detection of viral particle. Most virological laboratories can provide diagnostic information on the disease caused by enterovirus, herpes simplex virus, human immune deficiency virus etc. By providing a rapid diagnostic test or by isolation of virus the virology laboratories play a direct role in guiding antiviral therapy for patients with herpes simplex and

encephalitis. Although there is no specific drug available for enterovirus, attention needs to be paid to this virus since they are the most common cause of non bacterial meningitis. Sometimes diagnosis of the disease based on symptoms may cause confusion in case of bacterial and viral meningitis and the patients are treated wrongly with antibiotics. Proper virological diagnosis could be helpful for early withdrawal of antibiotics and for initiation of proper antiviral therapy. In virological laboratory the presence of viral particle in pathological sample could be detected as follows: a) Growth of virus in cell culture. b) Detection of virus specific antibodies in blood. c) Detection of viral antigen d) Detection of viral nucleic acid e) Gene sequencing to characterise the viral strain f) Detection with the help of electron microscopy g) Haemagglutinin assay.

- k) Role of virus in plant diseases:** Viruses are responsible for many plant diseases that lead to major economic loss. Tobacco Mosaic Virus (TMV), Potato Virus, Cauliflower Mosaic Virus (CMV) etc. are some important viruses which are very common and destructive plant viruses. Crop rotation, sanitation and use of resistant variety are common practices to avoid such diseases.

1.8 □ Bacteria

Bacteria are microscopic, vegetatively propagated prokaryotic living organisms which are ubiquitous in distribution and have immense ecological and economic importance.

Anton van Leeuwenhoek (Father of Microbiology) was the first person who observed bacteria through his self made single – lens microscope in 1674. On 16th June 1675, he first observed the existence of fungi, bacteria and protozoa in rain water and called them as “**animalcules**”. Ferdinand Cohn (1676) first identified some photosynthetic bacteria and proposed taxonomy for this microorganism. In nineteenth century, a lot of progress in bacteriological research had taken place which is chronologically summarized below:

Year	Events of discovery
1828	Christian Gottfried Ehrenberg introduced the name bacterium.
1853	Ferdinand Cohn categorised bacteria on the basis of their morphological shape, such as rod, spherical, thread and spirals. The rod shaped bacteria were divided into short and long rod types.

1857	Louis Pasteur demonstrated that the growth of bacteria can cause fermentation by their metabolic activity.
1876-77	That the bacteria can cause diseases was first shown by a German Doctor Robert Koch. He discovered anthrax bacillus (<i>Bacillus anthracis</i>) for which he won Nobel Prize in 1905.He also discovered <i>Bacillus tuberculosis</i> in 1882 and <i>Vibrio cholera</i> in 1883.
1877	Thomas J. Burrill first discovered that bacteria are the causal organism of plant diseases.
1884	Danish Physician, Hans Christian Gram discovered the most popular technique for staining of bacteria known as Gram staining that is being used till date for the identification and characterization of bacteria.
1887	S. Winogradsky, a Russian Microbiologist first explained the role of bacteria in biogeochemical cycle.
1890	Robert Koch postulated a four step technique to establish a relationship between a causative microbe and a disease (Koch's Postulates).
1910	Paul Ehrlich developed the first drug for syphilis.
1915-1917	Felix de Herelle and others discovered bacteriophage that can kill bacteria.
1928	Griffith Demonstrated experimentally the gene transfer of bacteria using pneumococcal bacteria.
1947	Lederberg and Tatum showed that the gene transfer between bacteria could be possible through conjugation.
1977	Carl Woese proposed a new domain of life form Archaea, which is a separate line of evolutionary descent from bacteria and eukarya.

1.9 □ General Characteristics of Bacteria

Bacteria have some unique features by which they could be distinguished from other prokaryotic microorganisms. The important features of bacteria are described below:

1.9.1 Shape and size

There is a great diversity in the shape and arrangement of cells in bacteria. The three basic shapes are cocci (spherical) bacilli (rod shaped) and spirilla (twisted) respectively. The spherical bacteria are called **cocci** (singular coccus). When coccus divides in one plane and remain attached in pair, such cocci are called **Diplococcus**. When the daughter cells produce as a result of uniplaner cell divisions and are arranged in linear chain, such arrangement is called **Streptococcus**. When cells divide in two planes and form group of four cells, they are called **Tetracocci**. Division of cell of cocci when occurs in multiple direction and the daughter cells are arranged in a branched chain, it is called **Staphylococcus**. Cells when divide in three planes in regular pattern and produce a bunch of cocci, such arrangement is called **Sarcinae**.

The rod shaped bacteria are called **bacilli**. The single celled free living bacilli are called **Monobacilli**. After division the cells remain adhered and appear in pair to form a structure called **Diplobacilli**. The daughter cells produced as a result of cell divisions arranged in the form of a chain like straws called **Streptobacilli**. The bacillus which to some extent looks like coccus is called **Coccobacillus**.

Spiral Bacterial cells having less than one complete twist are called **Vibrioid**. When twisting of the cells are more than one in number, such cells are called **helical**.

Besides, the above mentioned shapes there are other forms of bacteria. Some bacteria can change their shape according to the environment, they are called **pleomorphic** bacteria

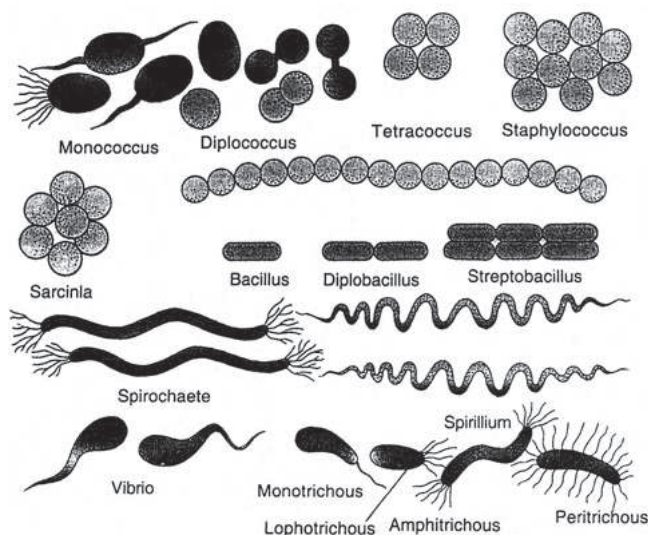

Fig. 1.9 : Different forms of bacteria.

(eg; *Rhizobium*, *Mycoplasma* etc.). When the contact area between the adjacent rod shaped cells arranged in the form of a chain are large, such cells of bacteria constitute a **trichomatous** arrangement (e.g. *Baaggiatoa*, *Saprospira*). The **palisade** like configuration developed by bacteria when cells are arranged laterally to form a match stick like pattern (eg. *Corynebacterium diphtheriae*). (**Fig. 1.9**)

1.9.2 Bacterial Nutrition

Bacteria can synthesize their food in the form of carbohydrate using carbon source, electron source and energy. All these raw materials required for carbohydrate synthesis may vary greatly in respect of their source among the bacteria and bacteria have been categorised into different types on that basis. Some bacteria use CO₂ as their major or even sole source of carbon; such organisms are termed as **autotrophs**. Others require organic compounds as carbon source and are called **heterotrophs**. When the bacteria rely on chemical compounds as an energy source, they are called **chemotrophs**. When radiant energy (light) is utilized by bacteria for synthesis of food, they are called **phototroph**. Electron source for carbon reduction to produce carbohydrate is essential requirement for bacterial nutrition. When inorganic compounds serve as electron donor, such bacteria are called **lithotrophs**. Other bacteria use organic compounds as electron donors and are called **organotrophs**. Some organisms are nutritionally recombinant and as such bacterial strains may be **chemolithotrophs** (chemical substances as energy source and inorganic substances as electron source), **photolithotrophs** (light as energy source and inorganic substances as electron source). Similarly bacteria may be **chemoorganotrophs** (Chemical substances as energy source and organic compounds as electron source) and **photoorganotrophs** (where light serves as energy source and organic compounds as electron source). Chemolithotrophic heterotrophs i.e. bacteria that obtain energy by utilizing inorganic electron donors, but obtain most of their carbon from organic compounds are called **mixotrophs**.

1.9.3 Bacterial Growth

The growth of bacterium does not mean its increase in size, it indicates the rate of increase in cell number as result of **binary fission**. Being prokaryotic in nature usual mitotic cell division is absent in bacteria. The process of binary fission is accomplished by the active role of the cytoplasmic organelle called mesosome. Bacterial nucleoid is found to remain attached with the mesosome during binary fission which suggest its positive role. Electron microscopic study reveals that during binary fission duplication of both mesosome

and nucleoid occurs. The mesosome begins to divide because of synthesis of membrane between the DNA-mesosome attachment sites. The proper segregation of nucleoids in the daughter cells occurs because of the attachment of mesosome with nucleoid. In Gram negative bacteria a bleb appears on the outer membrane where septum formation will occur. At the corresponding site of the cytoplasmic membrane a mesosome remains attached. Now the cytoplasmic membrane including peptidoglycan invaginates from opposite direction and meet with each other to form two daughter cells. Prior to septum formation duplication of the genome and complete separation of the daughter genomes into daughter cells occurs. (Fig. 1.10)

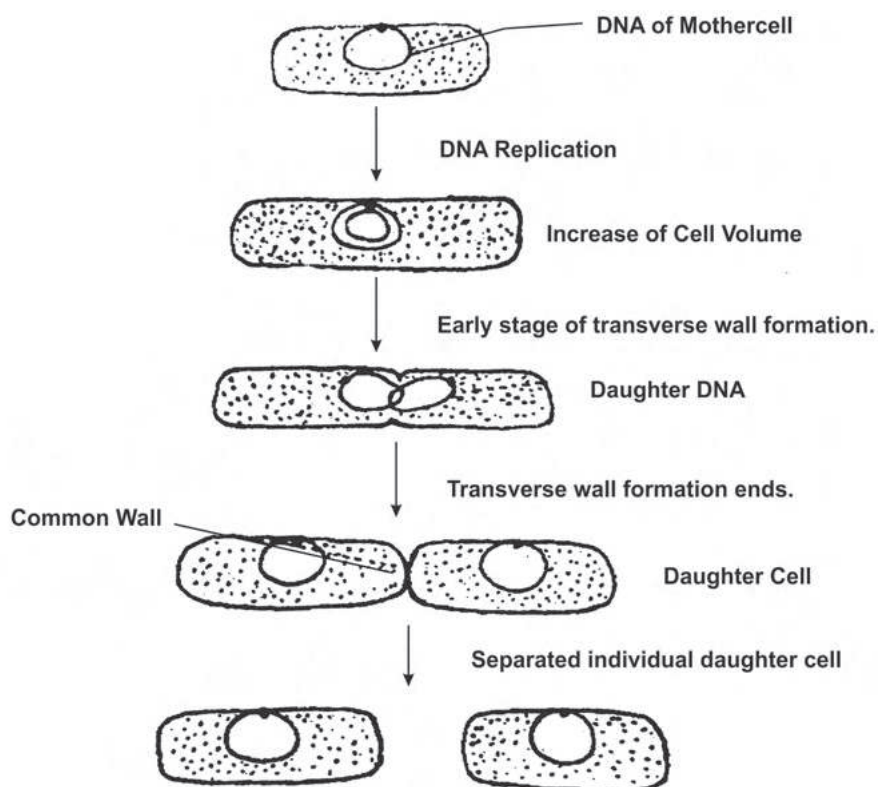

Fig. 1.10 : Steps of binary fission in bacteria.

The number of daughter cells due to binary fission becomes double in a particular time interval. Such time interval is known as **generation time (g)** and the number of generation exhibited by the bacterial cell per unit time is expressed as **growth rate (R)**. Generation time is species specific. Some bacteria double in very short time. For example generation time of *E.coli* is only 20 mins ($g=20\text{mins}$). Some others, like *Mycobacterium tuberculosis*

take a long time to divide into two ($g = 20$ hrs). If the increase of cell number in a growing bacterial population is expressed in respect of time a typical growth pattern is observed (**Fig. 1.11 a&b**) which consists of **lag phase, log phase, stationary phase and death phase**. The lag phase is the preparatory phase since during this phase cells acclimatize

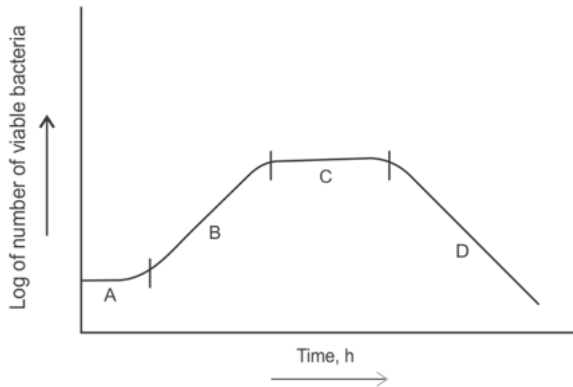

Fig. 1.11(a) : Typical bacterial growth curve. A, lag phase; B, log (logarithmic), or exponential, phase; C, stationary phase; D, death or decline phase.

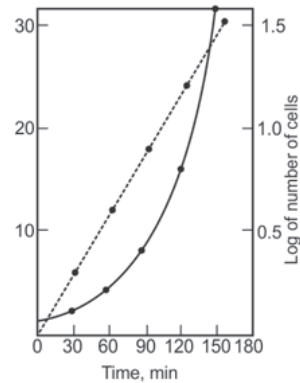

Fig. 1.11(b) : Hypothetical bacterial growth curve, assuming that one bacterial cell is inoculated into a medium and divisions occur regularly at 30-min intervals (generation time). - - - = logarithm of number of bacteria versus time; ____ = arithmetic number of bacteria versus time.

themselves to enter into the active growth phase. The genes related to growth become gradually activated but cells do not divide in this stage and therefore a lag in the cell division is observed. The log phase is known as exponential phase because the rate of increase in the cell number in the population occurs proportionately with respect of time as the cells remain in a metabolically active state. The growth rate and generation time could be represented by the following formula:

$$\text{Generation time (g)} = \frac{t}{n} = \frac{t}{3.3(\log_{10} N - \log_{10} N_0)}$$

[where n is the number of generation that occur in a particular time interval t]

N = Total population at the end of a given time period.

N_0 = The number of bacteria inoculated at the zero.

$$\text{Growth rate (R)} = \frac{3.3(\log_{10} N - \log_{10} N_0)}{t}$$

After the log, the cell number becomes static for the time being and such stage is called as stationary phase. There are two schools of thought explaining the static nature of cell number during this stage. According to one school the cells stop to divide due to nutrient exhaustion and the cell number does not increase any more whereas the other suggests that the division of cells continues but half of the daughter cells produced become dead due to nutrient deficiency and unfavourable growth conditions. This phase, where the number of new cells produced is more or less equal to number of older cells dead, is also known as a phase of **cryptic growth**. In the death phase many cells die and cell number decreases, though some cells begin to sporulate to remain dormant to overcome unfavourable period of growth, which come under the consideration of viable count keeping the declining line of the graph untouched to the X axis.

Different physico-chemical factors affect bacterial growth. Based on temperature requirement bacteria are classified as **Psychrophiles** (Bacteria which are able to grow at 0^o-10^oC), **Mesophiles** (Grow best within a temperature range of approximately 25-40^oC) and **Thermophiles** (grow best at temperatures greater than 45^oC). The gaseous substance oxygen exerts toxicity in anaerobic bacteria because they lack mechanisms to detoxify the harmful derivatives of oxygen like free radicals, hydrogen peroxides etc. The aerobic bacteria have such metabolic set up by which they could detoxify harmful oxygen derivatives. Harmful super oxide free radicals are removed in aerobic bacteria with the help of enzyme superoxide dismutase. Similarly another harmful derivative hydrogen peroxide is removed by the activity of catalase, peroxidase etc. The concentration of salts, acidity, alkalinity etc. in the growth medium is other parameters that regulate bacterial growth.

1.9.4 Metabolic characteristics

Different mechanisms are observed in bacteria for breaking down sugar (Glucose) to pyruvate in cytoplasm. Normal cytosolic glycolysis or EMP pathway is very common in aerobic bacteria. In anaerobic bacteria pyruvate produced by glycolysis is converted into lactate or other organic compounds like alcohol etc. In aerobic bacteria pyruvate is converted to acetyl CoA and enters into TCA cycle. An alternate pathway of glycolysis is observed in *E. coli*, *Clostridium*, *Pseudomonas* etc in which Dihydroxy acetone phosphate is converted into Methylglyoxal which later on gives rise to pyruvate. This pathway is known as **Methyl glyoxal pathway**. In *Rhizobium*, *Agrobacterium* etc. **Etner- Doudoroff Pathway** is followed for production of pyruvate. Pyruvate production is also reported in many bacteria through **Pentose Phosphate Pathway**. Normal TCA cycle reactions takes

place in bacteria despite the absence of mitochondria. Essentially, the cytoplasm and plasma membrane of a bacterial cell perform the same functions as the mitochondrial matrix and inner membrane respectively.

Photosynthetic bacteria have been classified into two broad groups such as **anoxygenic** and **oxygenic** group. Anoxygenic bacteria are of two types:

(1) Purple bacteria: These are anaerobic bacteria which grow in presence of light and do not use water as e-donor as in the higher plant. Purple bacteria are of two types: (a) **Purple sulphur bacteria (Family Chromatiaceae):** They are Gram negative and contain bacteriochlorophyll a (Bchl a) and bacteriochlorophyll b (Bchl b) and grow chemolithotrophically in dark with thiosulphate as electron donor. They may also be chemoorganotrophs or photolithotrophs. Eg. *Chromatium*, *Thiospirillum*, *Thiopedia* etc. (b) **Purple non-sulphur bacteria (Family : Ectothiorhodospiraceae) :** They also have Bchl a and Bchl b but they can use very low concentration of sulphide. Eg. *Rhodomicrobium*, *Rhodospirillum* etc.

(2) Green Bacteria: These bacteria are brown in colour, Gram negative, and contain Bchl c, Bchl d or Bchl e plus small amount of Bchl a. The photosynthetic apparatus is called chlorosomes which is made up of cylindrical tubules which remain attached to cytoplasmic membrane. These are called thylakoids. Green bacteria are of two types such as:

- (a) **Green sulphur bacteria (Family: Chlorobiaceae) :** They are non motile and may be rods, spiral and cocci. They do not possess gas vacuoles but have chlorosomes. They can assimilate simple oxygenic substances for photosynthetic growth if sulphur source is present. Eg. *Chlorobium*, *Chloroherpeton* etc.
- (b) **Green non sulphur bacteria (Family: Chloroflexaceae):** These are green, thermophilic, filamentous, non sulphur bacteria exhibiting gliding motion. They are usually thermophilic in nature. Eg. *Chloroflexus*.

(3) Heliobacteria: These are endospore forming, motile Gram positive rod shaped green bacteria which lack chlorosomes and bear cytoplasmic membrane bounded bacteriochlorophyll. They are found to grow in tropic soil of paddy fields. Eg. *Heliobacterium*, *Helophilum*, *Heliobacillus* etc.

Oxygenic bacteria include **Cyanobacteria** and **Prochlorophytes**. The former have phycobilins but the latter are devoid of phycobilins. Prochlorophytes contain both chlorophyll

a and b whereas cyanobacteria have only chlorophyll a. The thylakoids in prochlorophytes are paired.

1.9.5 Bacterial genetic recombination

Sexual reproduction is absent in bacteria. Therefore natural variation among the bacterial population is accomplished by different means. There are three methods of genetic recombination in bacteria, such as a) Transformation b) Transduction and c) Conjugation.

1.9.5.1 Transformation

It is the process of genetic recombination in bacteria in which genetic material from external environment is taken up by the bacterial cell and be converted into a new strain by integration of the external genetic material with its own genome. The genetic material which is taken up by the cell from external environment is called exogenote and the genome of the bacterial cell itself is known as endogenote. Bacteria usually in the late log phase of growth uptakes DNA due to the production of competence factors. When competence factors are produced by bacterial cell naturally and cells get transformed, such transformation is called **natural transformation**. However in many bacteria competence factor production can be induced artificially by addition of divalent cations to the culture medium to make the cell capable of undergoing transformation. Such transformation is called **artificial transformation**. Different protein factors are actively involved in the uptake of exogenote. Such proteins and their individual role are described below separately in Gram negative (*Neisseria gonorrhoeae*) and Gram positive bacteria (*Bacillus subtilis*).

In *N. gonorrhoeae*, the protein factors are :

- i) **Pil Q** : This protein helps to pass the DNA through outer membrane.
- ii) **Pilin complex Pil E** : It helps the DNA to pass the DNA through periplasm and peptidoglycan.
- iii) **Com E** : It is a DNA binding protein and helps in the firm binding of DNA so that the DNA could not be folded during its movement.
- iv) **N** : It is known as nuclease. It converts double stranded DNA into single stranded form.
- v) **Com A** : This protein helps in the construction of trans membrane channel through which DNA could pass easily into the cytoplasm. (**Fig. 1.12 a, b &c**)

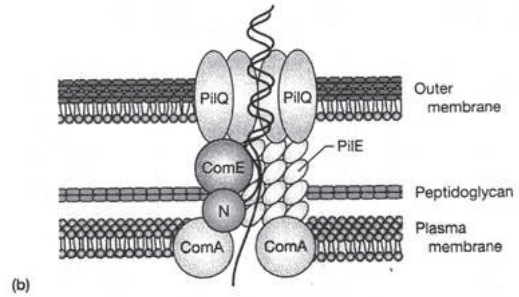
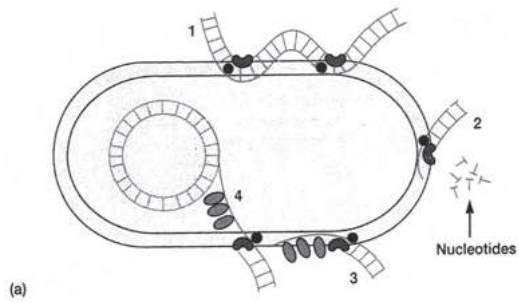
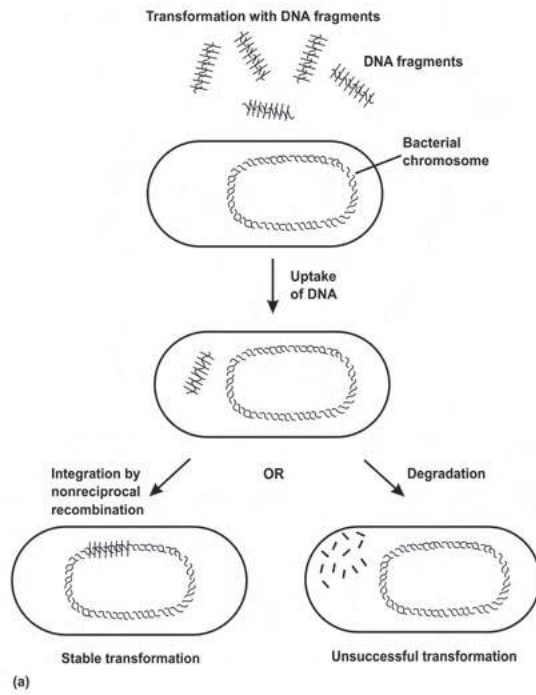

Transformation with a plasmid

DNA plasmid

Fig. 1.12(a) : Transformation with DNA fragments

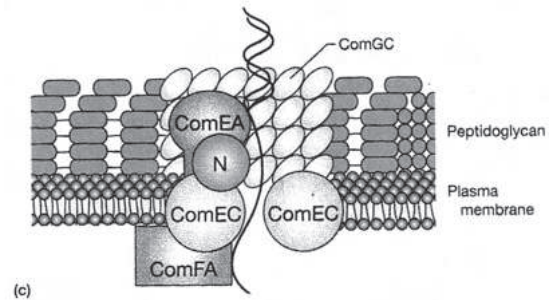
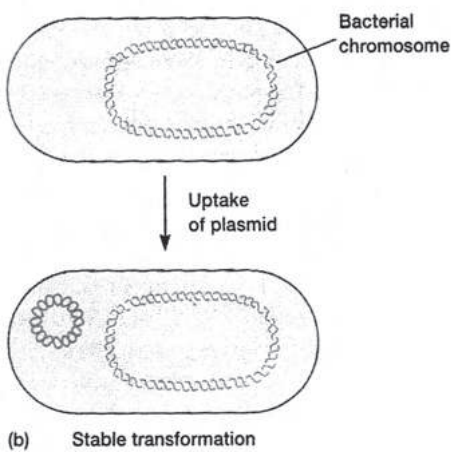

Fig. 1.12(c) : Molecular Mechanism of Transformation.

Fig. 1.12(b) : Transformation with a plasmid

In *B. Subtilis*, the pilin complex is known as Com GC, DNA binding protein is known as Com EA and channel forming protein is known as ComEC. Here nuclease is similar to

Gram negative bacteria which are designated as N. Com FA is a DNA translocase that moves the DNA into cytoplasm.

In *Haemophilus influenzae*, the exogenote enters in a double stranded form and it remains protected inside a sac like structure developed outside the cell called **transformosome. (Fig. 1.13)**

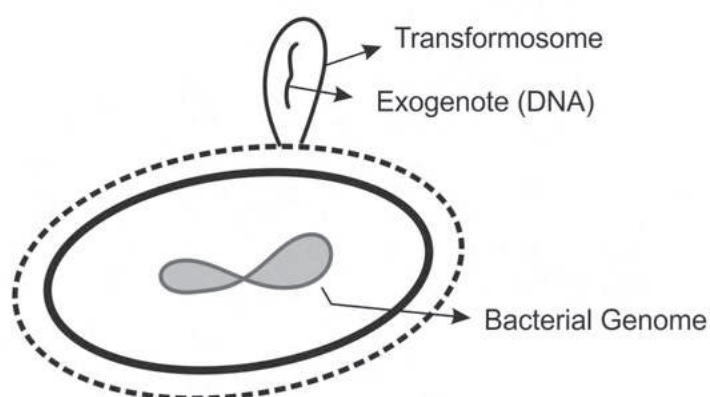

Fig. 1.13 : Uptake of genetic material through transformosome in *Haemophilus influenzae*.

1.9.5.2 Transduction

It is a method of genetic recombination in which genetic material from a donor bacterium is transferred to a recipient cell with the help of an intermediate phage particle. The recipient cell thus becomes a new recombinant. The phage particle which helps in the transfer of genetic material is known as transducing particle. Depending on whether the transducing particle is a lytic or lysogenic phage, transduction is categorised into two types such as a) Generalised transduction and b) Specialised transduction.

- a) **Generalised Transduction:** In this transduction lytic phage (e.g. T4) is involved. After entry of phage DNA into the host cell it replicates at the expense of the nucleotide of the bacterial genome itself. To supply nucleotides for phage DNA replication bacterial genome is fragmented. Now the replica of phage genome synthesizes viral proteins with the aid of host cytoplasmic machinery. The structural proteins of some phage during their assembly accidentally pack bacterial genomic fragment instead of their own genome. Thus progeny phage particles having bacterial genome are produced in addition to normal phage particles. The progeny particle with bacterial DNA fragment in its head is known as transducing particle. Such particle when infect a recipient cell genomic fragment from donor bacterium is transferred to the recipient making it a new recombinant strain. Since any

random DNA fragment without any specificity could be transferred from donor to recipient cell to give rise to new recombinant bacterium, it is called generalised transduction. (Fig. 1.14)

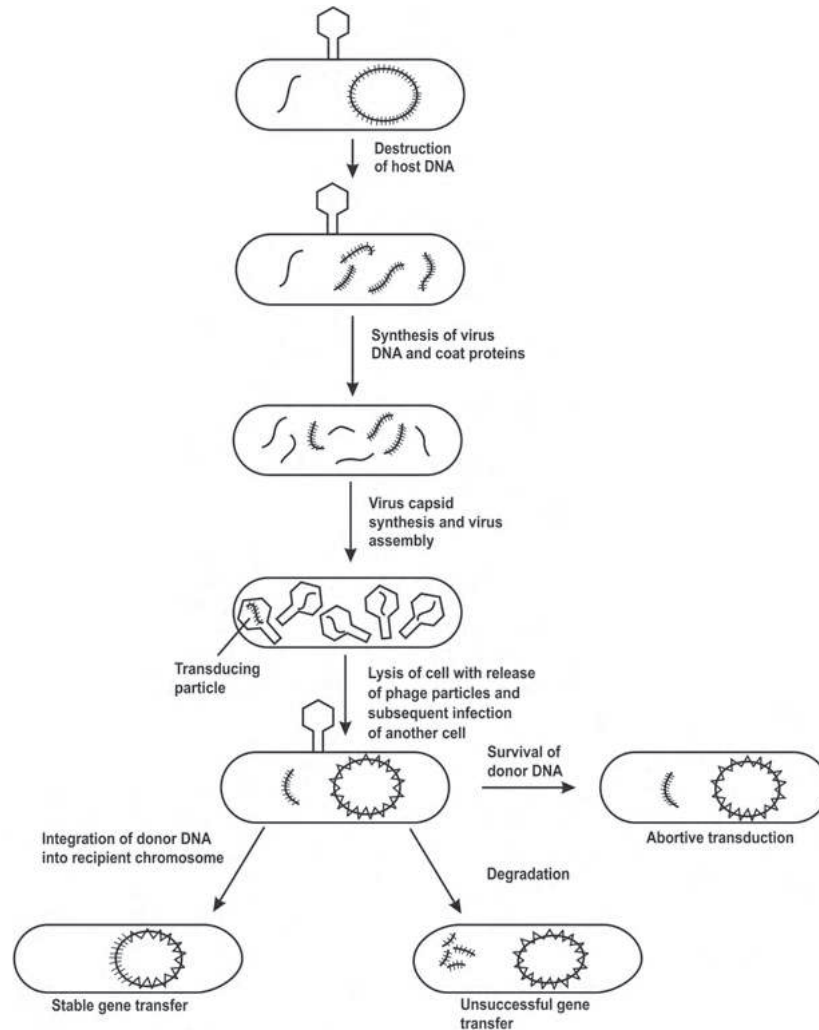

Fig. 1.14 : Generalized Transduction by Bacteriophages.

- b) **Specialised Transduction:** This type of transduction is mediated by lysogenic phage eg. λ phage. Here phage DNA after its entry into the bacterial cell is integrated with bacterial genome to form a prophage. Due to induction phage genome separates from prophage by taking a specific part of bacterial genome (in *E. Coli*, it is 'gal' or 'bio' gene). Such separated phage genome with specific bacterial gene replicates in expense of host genome. The structural proteins of

phage are synthesized from its genome as usual. The progeny particle produced after assembly thus has its own genome in part along with the bacterial specific gene.. Such progeny particle is called transducing particle (also called λ dgal since it carries donor bacterial gal gene). When such transducing particle infects a recipient cell genetic recombination occurs and the recipient (gal^-) bacterium is converted into gal^+ recombinant bacterium. They are called 'd' or defective because by accommodating 'gal' gene it leaves some essential genes in bacterial genome and therefore are unable to multiply inside the new host after infection. So the host cell survives and expresses the newly acquired gene. (Fig. 1.15)

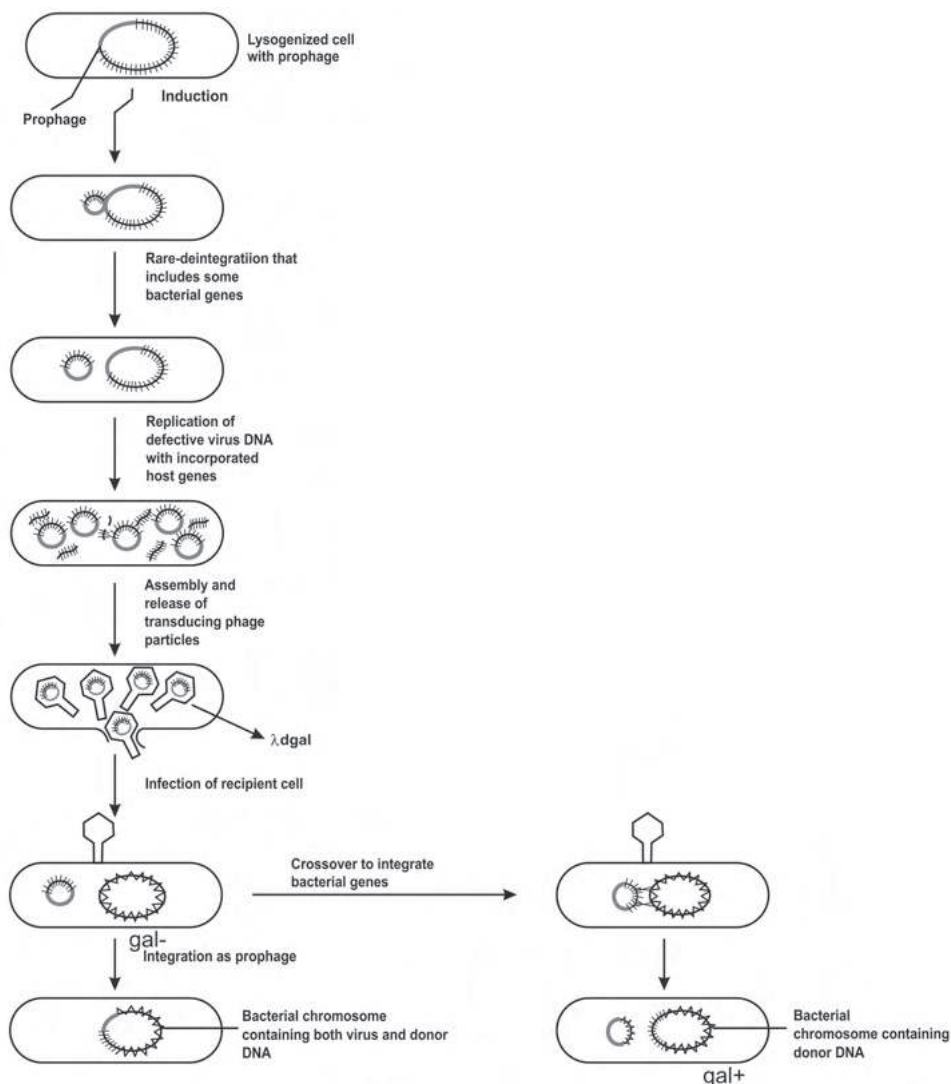

Fig. 1.15 : Specialized Transduction by a Temperate Bacteriophage.

1.9.5.3 Conjugation:

That the recombination of genetic material between two bacterial cells occur by conjugation was first experimentally demonstrated by Joshua Lederberg and Tatum (1946) in *E. coli*. They mixed two triple auxotrophic strains (Strains that could not synthesize specific nutrients and need the supply of such for their growth in artificial medium). One is $\text{Bio}^- \text{Phe}^- \text{Cys}^- \text{Thr}^+ \text{Leu}^+ \text{Thi}^+$ and the other is $\text{Bio}^+ \text{Phe}^+ \text{Cys}^+ \text{Thr}^- \text{Leu}^- \text{Thi}^-$. The cultures were incubated for several hours in nutrient medium and then plated it on minimal medium. They found the growth of prototrophic colonies ($\text{Bio}^+ \text{Phe}^+ \text{Cys}^+ \text{Thr}^+ \text{Leu}^+ \text{Thi}^+$) on the minimal medium. Organisms which are able to grow on minimal medium and do not need any growth supplements are called **Prototrophs**. On the other hand organisms which need supplementation in growth medium with specific nutrients are called **Auxotrophs**. They concluded that the genome of two auxotrophs had undergone recombination to produce a prototroph. (**Fig. 1.16**)

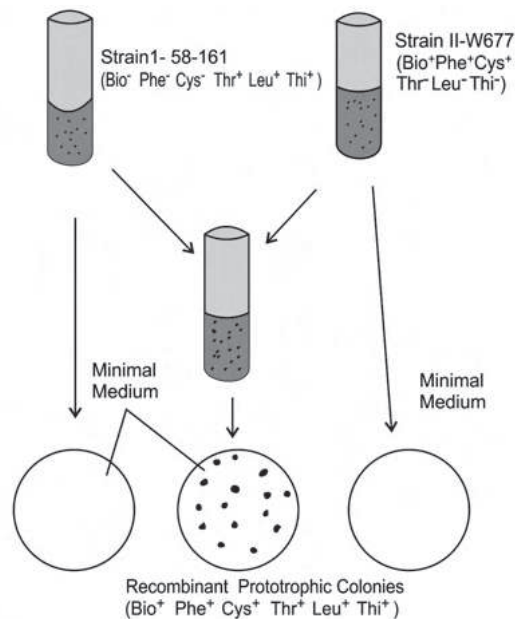

Fig. 1.16 : Demonstration of Lederberg and Tatum's experiment of bacterial conjugation by using triple auxotrophs.

Bernard Davis (1950) performed U tube experiment in which at the bottom of the tube a filter was used through which bacteria could not pass but media can pass from one side to other. He took culture medium in the tube and different double auxotrophic mutant was used in each side of the tube. Using suction device medium is allowed to move back and

forth through the filter and then incubated for 4 hours. (**Fig. 1.17**) After incubation the suspension was plated in the minimal medium. It was discovered that when two auxotrophs remain separated by the filter, gene transfer could not take place. So, direct contact between two cells is necessary for genetic recombination to occur. There are three types of conjugation:

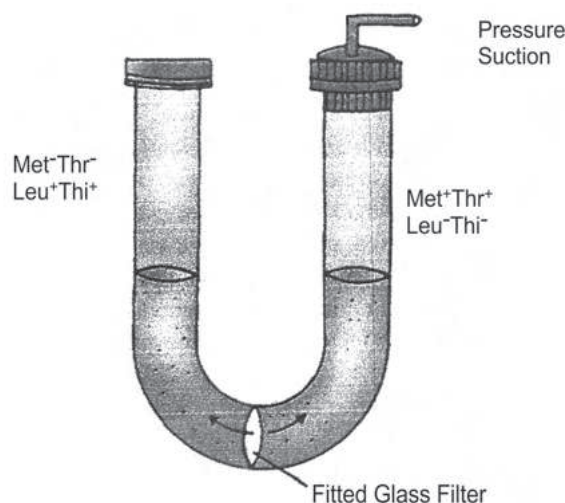

Fig. 1.17 : The U-tube experiment of Bernard Davis to show the need of cell-to-cell contact for conjugation.

- i) **F⁺ x F⁻** : In 1952, W. Hayes demonstrated that gene transfer through physical contact requires the involvement of two kinds of cells such as F⁺ and F⁻. The cytoplasm of F⁺ contains an extra chromosomal factor that contains gene for pilin protein. Such proteins are organised to form conjugation tube. The cytoplasmic factor is known as F factor or **episome** as it is capable of replicating independently as well as in integrated state. The cytoplasm of F⁻ cell lacks the episome. The conjugation tube from F⁺ proceeds towards F⁻ and fuses with it to establish connection in between. Now the F plasmid replicates and a copy or replica of F passes through the conjugation tube into the F⁻ cell, converting the latter into F⁺. After the transfer of the replica of F plasmid the conjugation tube breaks and both the conjugant becomes F⁺. (**Fig. 1.18**)
- ii) **Hfr x F⁻** : A second type of conjugation exists in which F plasmid from donor bacterium after transfer integrates with the recipient bacterial genome by recombination. Such recombinant genome perform rolling circle mode of replication and transfer genetic material to F⁻ recipient cell. Such donor cell is known as **Hfr** (High frequency of recombination) **strain**. It exhibits a very high efficiency of gene transfer compared to the F⁺ strain for which it is so named. Due to Hfr and

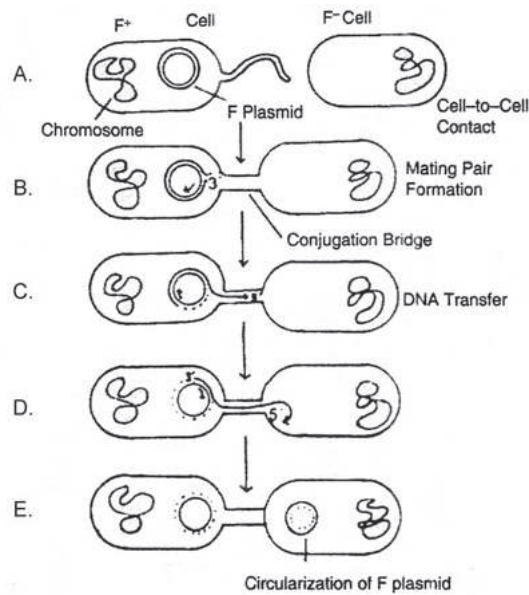

Fig. 1.18 : Steps in F plasmid transfer. A, cell-to-cell contact; B, formation of matching pair; C-D, DNA transfer; E, circularization of transferred DNA.

F⁻ conjugation the entire episome does not usually transfer into the recipient cell and therefore the F⁻ recipient does not become F⁺. During the partial transfer of episome from Hfr through conjugation a part of donor bacterial genome frequently transfers along with episome into the recipient and incorporated into F⁻ genome by recombination. **(Fig. 1.19)**

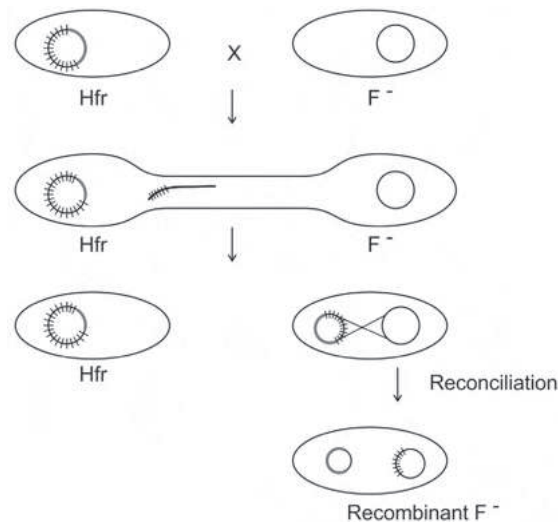

Fig. 1.19 : Conjugation between Hfr & F⁻ resulting into the formation of F⁻ recombinant bacterial strain (See the text for description)

- iii) **F' X F⁻** : The episome which remains integrated with the bacterial genome of Hfr may sometimes be separated at low frequency and form free F factor in the cytoplasm. Such F factor during separation from bacterial genome may take a small segment of chromosome. The bacterial cell with such kind of F factor is known as F' cell. F' cells are of two types. In **Type I F'** cell the episome contains a part of host genome of one side where episome remains attached to the host chromosome. In **Type II F'** cell the episome carries host genome from both side of the point where episome was integrated with host chromosome. When such F' cell conjugates with the recipient F⁻ cell, the F factor is transferred and convert F⁻ into the secondary F' cell. As the secondary F' cells are partially diploid they are called **merodiploid** or **merozygote**. The partial diploid nature of the recipient cell is due to having a segment of DNA from donor cell in addition to its own genome. The process of formation of merozygote was called **sexduction** by Jacob and Wollman (1961). [Figs. 1.20 (a) & (b)]

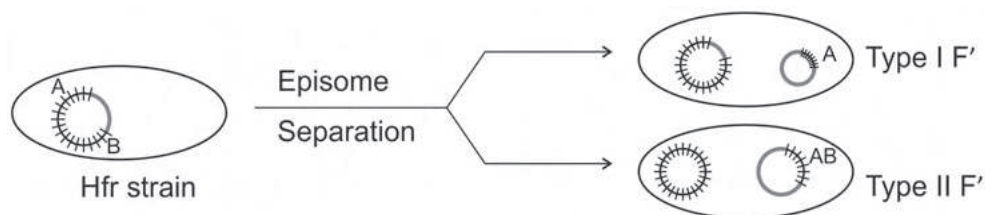

Fig. 1.20(a) : Origin of F' strain due to separation of episome from Hfr strain.

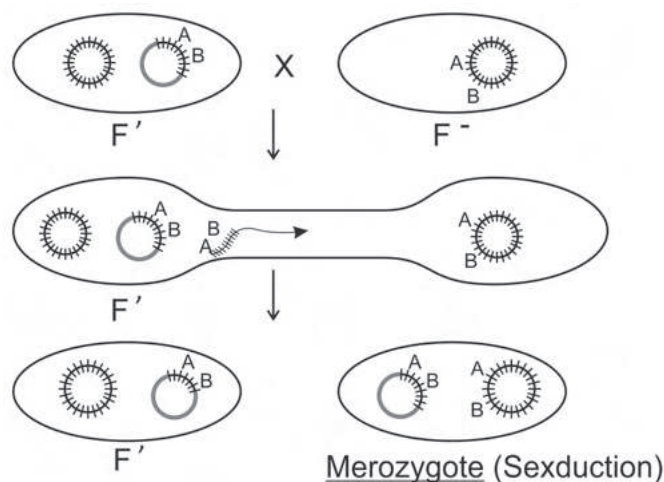

Fig. 1.20 (b) : Conjugation between F' & F⁻ strain that results into the development of partial diploid or merozygote. (See the text for description).

1.9.6 Bacterial sporulation

When bacterial cells are subjected to unfavourable conditions, they form endogenously produced spherical, thick walled resting body within their cells to overcome unfavourable period of growth. Such resting body within bacterial cell is called **endospore**. Many Gram positive rod shaped bacteria produce endospore, though the production of endospore by spherical bacteria are not less common (eg. *Sporosarcina*). Depending upon the location of spore the shape of the cell may alter. [Fig. 1.20(c)]

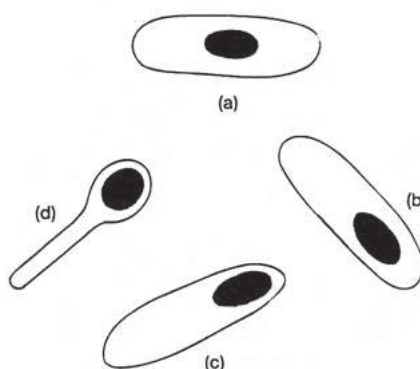

Fig. 1.20(c) : Examples of Endospore Location and Size, (a) Central spore, (b) Subterminal spore. (c) Terminal spore, (d) Terminal spore with swollen sporangium.

At the centre of the endospore there is a core which contains sporoplasm with ribosomes and nucleoid. The central core remains covered by a boundary wall called core wall. Next to the core wall the broad wall layer is located which is called cortex. This cortex layer is made up of spore peptidoglycan which is mainly responsible for imparting rigid nature of endospore wall. This layer is also impervious to heat and temperature. The spore peptidoglycan layer is made up of repeating units of three dimers of N-acetyl glucosamine (NAGA) and N-acetyl muramic acid (NAMA) with different groups remain attached with NAMA. In the NAMA of the first dimer there is the attachment of L-alanine residue and in the NAMA of second dimer tetrapeptide remains attached to constitute tetrapeptide subunit. A lactic acid moiety however remains attached to the NAMA of third dimer to constitute muramyl lactam subunit (**Fig. 1.21**). Outside the cortex layer another thick layer is present which is known as spore coat. The spore peptidoglycan accumulates in between core wall and spore coat to form cortex during the process of sporogenesis. In some bacterium another additional layer is present outside the spore coat which is known as exosporium or exine. Inside the sporoplasm calcium dipicolinic acid (DPA) accumulates

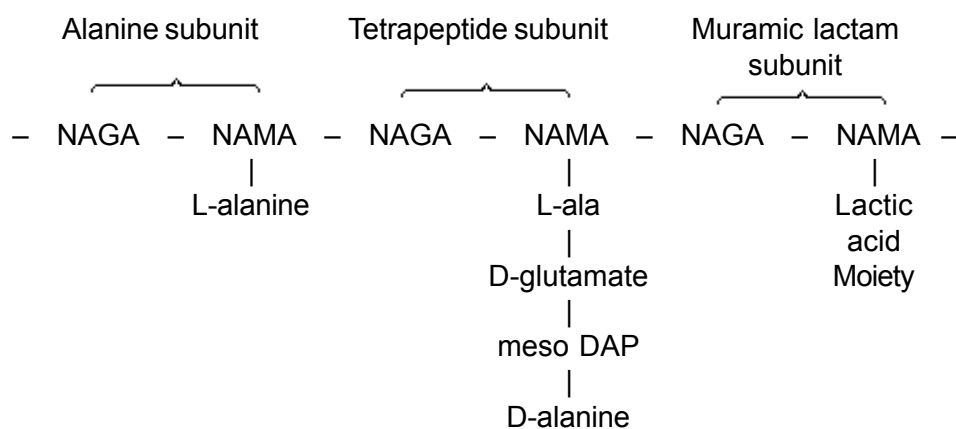

Fig. 1.21 : Chemical composition of spore peptidoglycan.

which is responsible for the heat resistant property of the endospore. On return of favourable condition the endospore containing cell gives rise to a new bacterium. (**Fig. 1.22**)

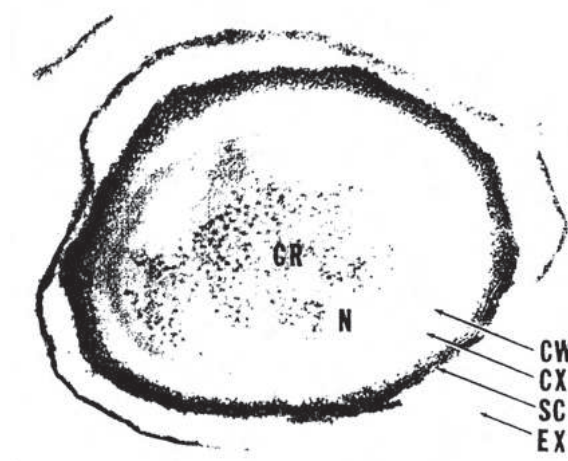

Fig. 1.22 : Endospore Structure. *Bacillus anthracis* endospore (X151,000). Note the following structures; exosporium, Ex; spore coat, SC; cortex, CX; core wall, CW; and the protoplast or core with its nucleoid, N, and ribosomes, CR.

1.9.7 Structure of bacterial cell

On the basis of staining reactions bacterial cells have been categorised into Gram + and Gram – bacteria. Both Gram + and Gram – bacteria are covered by chemically different thick wall layer. The cytoplasm in both contains cytoplasmic organelles and genetic materials. The different components of bacterial cell are discussed below:

1.9.7.1 Cell Wall

The cell wall of Gram positive bacteria is more rigid than Gram negative bacteria because of having high percentage of building material (75-80%) known as peptidoglycan. In Gram negative bacteria peptidoglycan serves as secondary wall component and it occupies only 15-20% of the dry weight of the cell wall. Here lipid and polysaccharide constitutes the primary wall component. The peptidoglycan which is also known as murein or glycopeptides is basically a polymer made up of two monomers, one is a sugar amine i.e. N-acetyl Glucosamine (NAGA) and the other is a sugar acid known as N-acetyl muramic acid (NAMA). [Fig. 1.23(a)] Both the monomers are linked together by β -1,4 glycosidic linkage which is susceptible to enzyme viral lysozyme. During infection virus breaks this linkage and fragments the cell wall. Viruses which pack lysozyme from the host cell penetrate a new host cell using this lysozyme to form 'holes' in the cell wall. The murein layer of Gram positive bacteria comes directly in contact with viral lysozyme during the attack since no protective covering lies outside the murein layer. On the other hand, Gram negative bacteria have distinct outer envelope made up of lipid and polysaccharide surrounding the murein layer, so that viral lysozyme could not come in direct contact with the wall layer, making the cell less susceptible to viral attack. In the peptidoglycan polymer NAMA is very important because of its variability in different attached groups and cross linkage in between. Murein has been categorised into two types, such as **Group A** and **Group B**

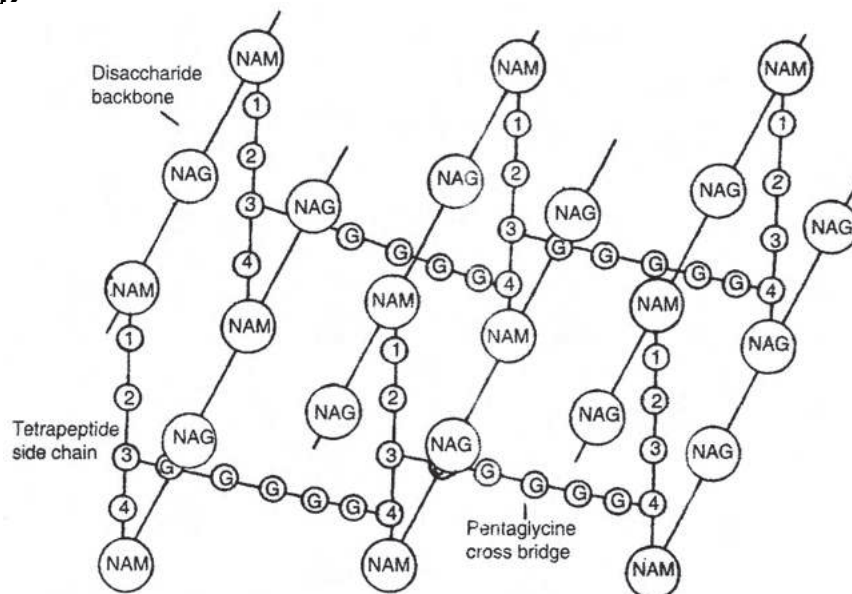

Fig. 1.23(a) : Organisation of peptidoglycan layer of *Staphylococcus aureus*, 1, alanine, 2, D-glutamate; 3, L-lysine; 4, D-alanine; G, glycine.

In **Group A murein**, third amino acid of tetrapeptide chain of NAMA remains cross linked with the fourth or terminal amino acid of the adjacent tetrapeptide chain. The cross linkage may be direct and the amino acid sequence of the tetrapeptide chain is L-alanine-D- glutamic acid- meso-diaminopimelic acid (DAP)- D-alanine. (**Fig. 1.23 b, c**) In case of indirect cross linkage diverse type of linker molecules (Eg. Pentaglycine) play role in the establishment of linkage and in such cases amino acid component at the third position of tetrapeptide is Lysine instead of DAP (**Fig. 1.24**).

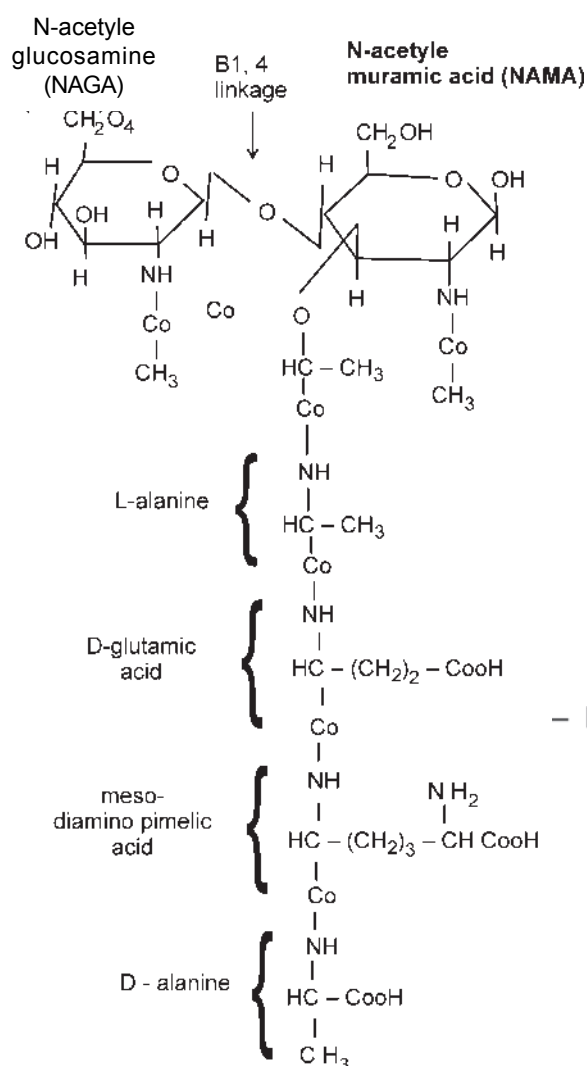

Fig. 1.23(b) : Chemical structure of the peptidoglycan polymer with attached tetrapeptide submit with N-acetylmuramic acid (NAMA)

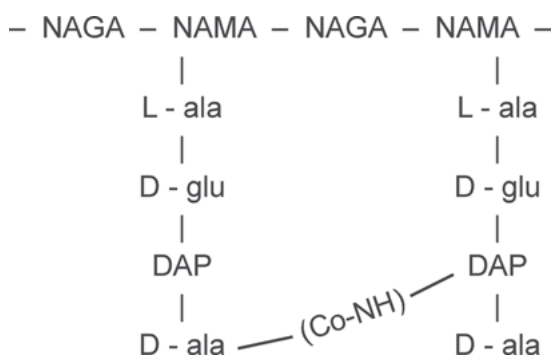

Fig. 1.23(c) : Direct 3,4, cross linkage (peptide bond) between the adjacent tetrapeptide chain of NAMA present in peptidoglycan polymer.

In **Group B murein**, the adjacent tetrapeptide chains are connected with each other by 2,4 transpeptide linkage and such linkage is usually indirect. The amino acid composition of tetrapeptide is Glycine- D- glutamic acid- Lysine –D- alanine and here D glutamic acid at the second position is cross linked with the terminal ones of the adjacent tetrapeptide with the help of different types of linkers (**Fig 1.25**).

In Gram positive bacteria as a **secondary wall component** a compound is found which is known as **teichoic acid**. Such secondary wall component as acidic polymer of glycerol phosphate or ribitol phosphate remains attached to peptidoglycan by covalent bond. Techoic acid helps to protect bacteria from thermal injury.

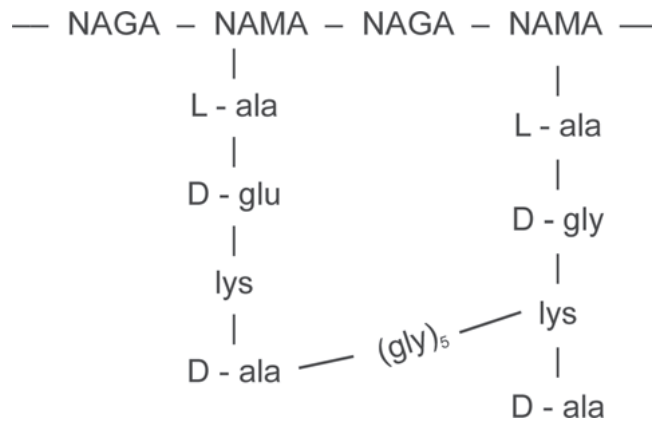

Fig. 1.24 : Indirect cross linkage (3,4) between the adjacent tetrapeptide chain involving pentaglycin.

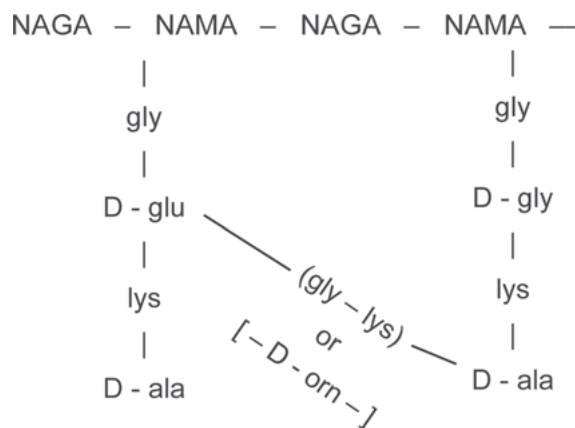

Fig. 1.25 : Chemical Composition of Group B murein.

In Gram negative bacteria outside the thin layer of peptidoglycan a membranous envelope is present which is known as **outer membrane**.

1.9.7.2 Structure of the outer membrane

This layer is impermeable and protects bacteria from harmful substances of external environment. Outer membrane remains attached to the underlying peptidoglycan by means of **Braun's lipoprotein**. Outer membrane is a bilayered structure and made up of **phospholipids, protein and Lipopolysaccharide (LPS)**. (Fig. 1.26 a&b) LPS is located **outside** to the outer membrane and it imparts toxic property of the cell and is also known as endotoxin. LPS is composed of three regions from inside to outside the regions are: **lipid A**, the **R core region**, and the **O side chain**. Although outer membrane is impermeable, it allows certain molecules to pass across (e.g. Small peptides, oligosaccharides, nucleosides etc.) by means of a channel forming protein called **Porin**.

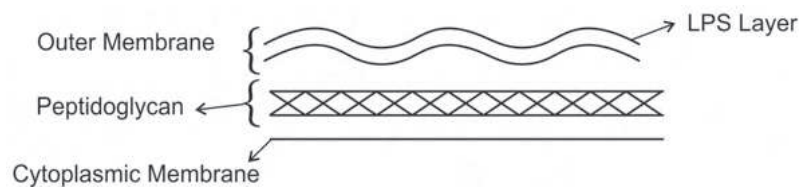

Fig. 1.26(a) : Diagrammatic representation of the cell wall of Gram negative bacteria.

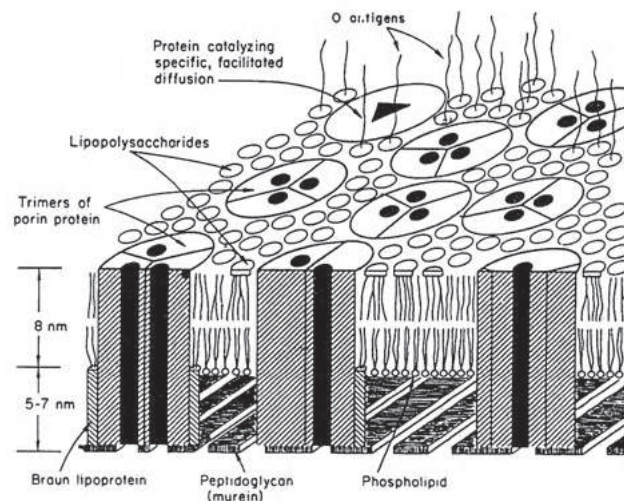

Fig. 1.26 (b) : Tentative model of the cell wall of a Gram-negative bacterium like *Escherichia coli* or *Salmonella typhimurium*. Not shown is the cytoplasmic membrane, which is located below the peptidoglycan layer. The 8-nm-thick outer membrane of the cell wall is separated from the peptidoglycan layer by a 5 to 7 nm space. Molecules of Braun's lipoprotein extend across this space and anchor the outer membrane to the peptidoglycan. porins extend from the external surface of the outer membrane down to the peptidoglycan layer. (Courtesy of H. Nikaido and T. Nakae, *Adv Microbial Physiol* **20** : 163, 1979.)

1.9.7.3 Cytoplasmic membrane

The cytoplasmic membrane of bacteria is approximately 7.5 nm thick and is made up of phospholipids and proteins. The phospholipids form a bilayer in which two types of protein such as integral and peripheral proteins are present. In eubacteria the phospholipids are phosphoglycerides whereas in archaeobacteria the lipids are polyisoprenoid branched chain lipids. In the former the straight chain fatty acids are ester linked to glycerol whereas in the latter long chain branched alcohols or phytanols are ether linked to glycerol. In Gram positive bacteria the cell wall could be removed by enzyme treatment or by the application of cell wall synthesis inhibitory antibiotics to give rise to cytoplasmic membrane bounded round structure called **protoplast**. In Gram negative bacteria the same treatment though remove thin cell wall but outer membrane is retained and give rise to double membrane bounded spherical structure called **spheroplast**.

1.9.7.4 Membranous intrusions

Bacterial cytoplasm lacks membrane bound cytoplasmic organelles like mitochondria, chloroplast etc. The localised infoldings of the plasma membrane give rise to a membranous structure called mesosome. It is made up of vesicles and tubules of lamellar whorls. Mesosomes are found near the site of cell divisions or nuclear area. The exact function of mesosomes though unknown but it has been suggested that they play active role in bacterial respiration. It determines the site of origin of constriction during binary fission. In some purple bacteria the vesicular bodies are flattened and stacked into a regular plate like structure called thylakoids.

1.9.7.5 Cytoplasm

The cytoplasm of a typical bacterial cell is divided into three regions such as : a) Granular area rich in macromolecular RNA –protein bodies known as ribosomes b) The chromatin area and c)The fluid portion with dissolved substances. The ribosomes have a sedimentation coefficient of 70 Svedberg Units (70S) and are composed of two subunits, a 50 S and 30S.

1.9.7.6 Granular inclusions

In the granular area different types of inclusions are found such as: i) **Volutin granules**: These are known as polyphosphate or metachromatic granules and are used for synthesis of ATP and nucleic acids. ii) **PHB**: These are polymer of poly β hydroxyl butyric acid, present as a storage material in the cytoplasm and serves as a carbon and energy source. (**Fig 1.27**) iii) **Glycogen**: These are polymer of glucose and also serve as reservoir for

carbon and energy. iv) **Carboxysomes** : These are enzyme containing granular inclusions which contain Ribulose biphosphate carboxylase (RUBISCO) required for carbon dioxide fixation during photosynthesis. v) **Sulphur granules**: In photosynthetic purple sulphur bacteria which grow under anaerobic sulphur rich environment (e.g. *Thiobacillus*, *Thiospirillum*, *Thiocapsa* etc.) these inorganic inclusions are found (**Fig. 1.28**). vi) **Magnetosomes** : In magnetotactic bacteria intracellular chains of 40-50 membrane bound magnetite(Fe_3O_4) particles (40-100 nm diameter) are found which help the bacteria to determine northward and downward directions. These particles are called magnetosome.

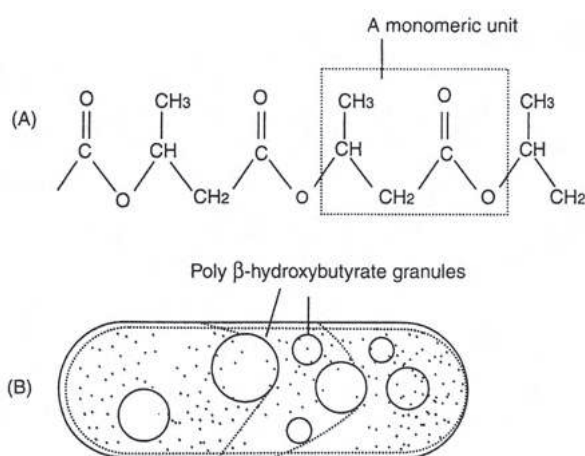

Fig. 1.27 : (A) Chemical structure of poly β -hydroxybutyrate (PHB), (B) *Rhodospirillum sodomense* containing granules of poly β -hydroxybutyrate (PHB).

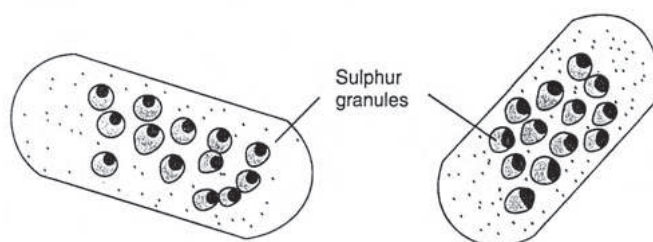

Fig. 1.28 : Cytoplasmic inclusions found in some bacteria. (Intracellular sulphur granules found in *Chromatium vinosum*).

(**Fig. 1.29**) vii) **Gas vesicles**: In many bacteria gas filled vesicles are found in cytoplasm which provide buoyancy and keep the cell in floating form. (**Fig. 1.30**) viii) **Chlorosome**: In green bacteria photosynthetic pigment bacteriochlorophylls are present in an ellipsoidal vesicle called chlorosome (**Fig. 1.31**).

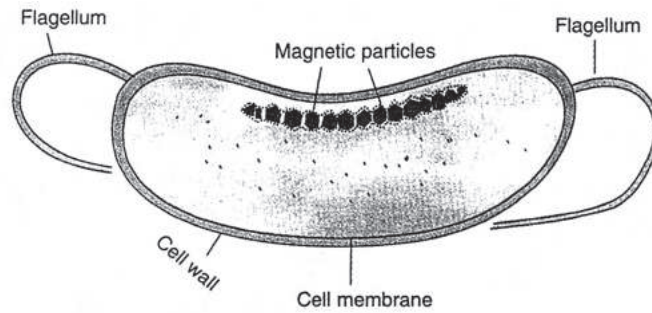

Fig. 1.29 : Magnetotactic bacterium (*Aquaspirillum magnetotacticum*) showing magnetosomes arranged in a chain (diagrammatic).

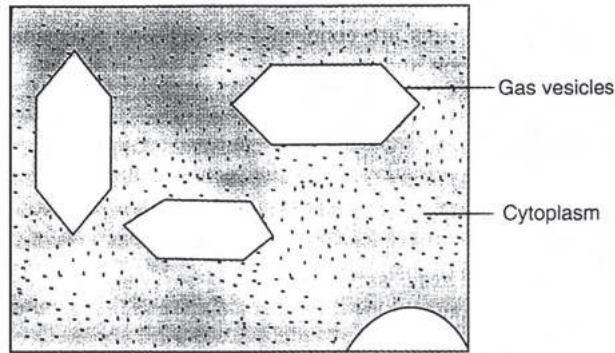

Fig. 1.30 : A portion of bacterial cell showing gas vesicles (diagrammatic)

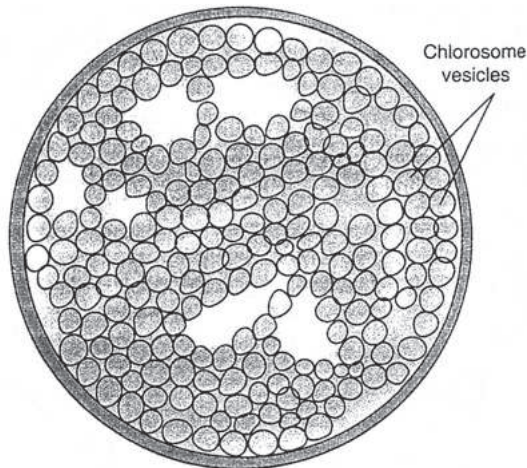

Fig. 1.31 : *chromatium sp.* showing individual vesicle (diagrammatic).

1.9.7.7 Nucleoid

The bacterial chromosome present at the central region of the cell is known as nucleoid. The genetic material does not remain separated from the cytoplasm by any membrane. The

DNA does not remain associated with histone like proteins and therefore it cannot produce nucleosome like structure. The nucleoid is observed as a coral like body with the branches of multiple supercoiled scaffolds which spread far into the cytoplasm. Generally the number of nucleoid per cell is one but in some bacteria the number may be four or more. The nucleoid is made up of a single circular DNA which forms loops or domains surrounding the central protein and RNA core (**Fig. 1.32**).

1.9.7.8 Bacterial Plasmid

Plasmids are defined as extra chromosomal free cytoplasmic genetic material (usually double stranded DNA molecule) which carries important genes related to specific properties

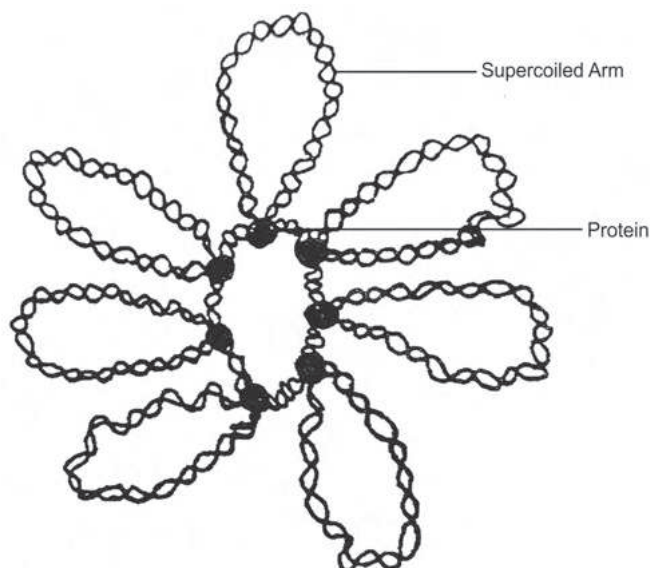

Fig. 1.32 : Structure of nucleoid or genophore.

of the bacterial cell. Plasmid may be present in the cytoplasm in a supercoiled form such configuration is described as ccc i.e. covalently closed circular DNA. Plasmid may be **conjugative** or **non conjugative**. (**Fig. 1.33**) The former carries genes that promote the transfer of the plasmid from a donor to recipient cell by conjugation. The latter could not promote its own transfer by conjugation. **R plasmid** is a type of plasmid which imparts resistance to the bacterial cell against different antibiotics due to the presence of genes for resistance. **Col plasmids** encode certain proteins which prevent the growth of related strains of bacteria. The encoded proteins produced by the plasmid are known as **bacteriocins**. **Ti plasmid** (Tumour inducing plasmid) is another kind of plasmid present in *Agrobacterium tumefaciens* which encodes factor responsible for tumour induction. Low molecular weight DNA molecules have been reported in cytoplasm of some bacteria which

have no specific biological role; such plasmids are called **cryptic plasmid**. Besides, there are plasmids in bacterial cells which encode specific toxins responsible for pathogenicity of the bacteria. Enteric plasmids, Hly plasmids are example of such type.

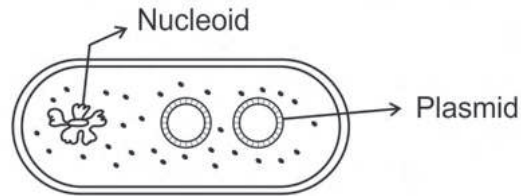

Fig. 1.33 : Bacterial Cell with plasmid.

1.9.7.9 Bacterial flagella

Flagella are hair like helical surface appendages that protrude through the cell wall and are mainly responsible for motility of bacterial cell. The number and distribution pattern of flagella on the cell may vary among the bacteria. When a single polar flagellum is observed, such bacterium is called as **monotrichous** (E.g. *Pseudomonas aeruginosa*). A bunch of

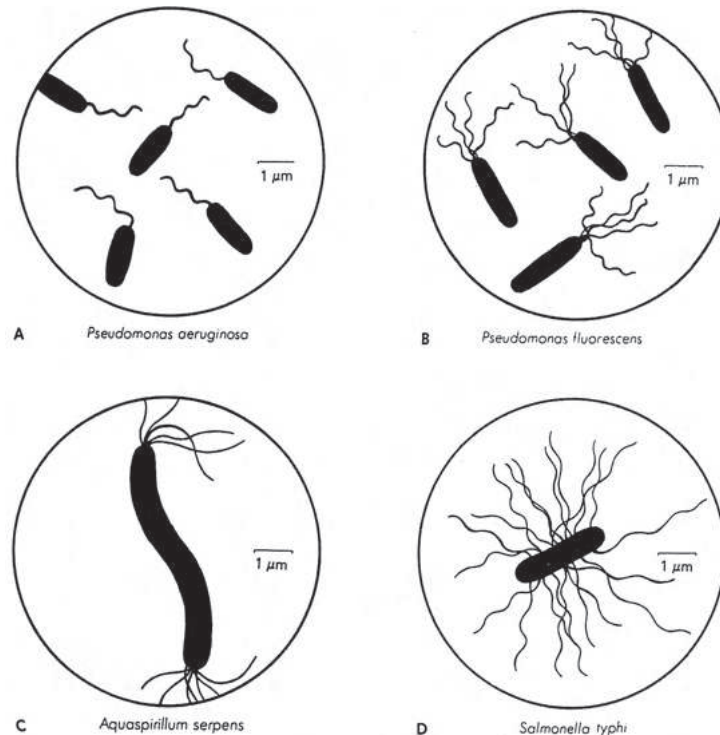

Fig. 1.34 : Drawings of various arrangements of bacterial flagella. (A) Monotrichous; a single polar flagellum. (B) Lophotrichous; a cluster of polar flagella. (C) Amphitrichous; flagella, either single or clusters, at both cell poles. (D) Peritrichous; surrounded by lateral flagella, (*Erwin F. Lessel, illustrator*)

polar flagella attached with a rod shaped cell is known as **Lophotrichous** (e.g. *P. fluorescens*). An **Amphitrichous** bacterium develops where two bunches of flagella attached with the rod shaped cell (e.g. *Aquaspirillum serpens*). The bacterium where flagella are distributed on the entire surface is known as **Peritrichous** arrangement (e.g. *salmonella typhi*). There are three main parts of a flagellum such as: Basal body, hook and Filament. The flagellum may be up to 15 μ m long and about 20-30 nm thick. (**Fig. 1.34**)

Basal Body: In Gram negative bacteria the basal body is made up of four rings fitted on a central rod impregnated inside the cell wall. The rings corresponding to the plasma membrane and periplasmic space are known as M and S ring respectively. These two rings form a pair and another pair is constituted by P and L ring which are impregnated in peptidoglycan and Lipopolysaccharide layer of the outer membrane respectively. S & M ring form proximal set whereas L & P ring form distal set.

Hook: The basal body and filament or shaft of the flagella is connected with each other by a curved structure called hook. The hook of Gram positive bacterial flagellum is usually longer than gram negative flagellum.

The filament or shaft: It is a thin elongated proteinaceous structure. The protein is termed as flagellin. The filament and hook are made up of spherical or ovoid flagellin subunits about 5 nm in diameter. The flagellin subunits are helically arranged to form cylindrical fibrils leaving a central hollow space. The flagellin subunit of *Bacillus subtilis* is

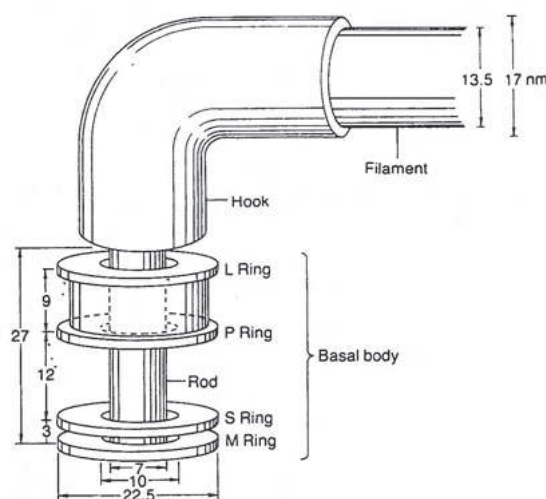

Fig. 1.35 (a) : Diagrammatic model of the basal end of the flagellum of *E. coli*, based on electron micrographs of the isolated organelle. From M. L. De Pamphills and J. Adler, "Fine Structure and isolation of the Hook-Basal Body Complex of Flagella from *Escherichia coli* and *Bacillus subtilis*, *J. Bacteriol.* **105**, 384 (1971).

made up of a single polypeptide of 304 amino acid residues and has a molecular weight of 32,600. The detail structure of bacterial flagellum is given in the figure (Fig. 1.35 a&b).

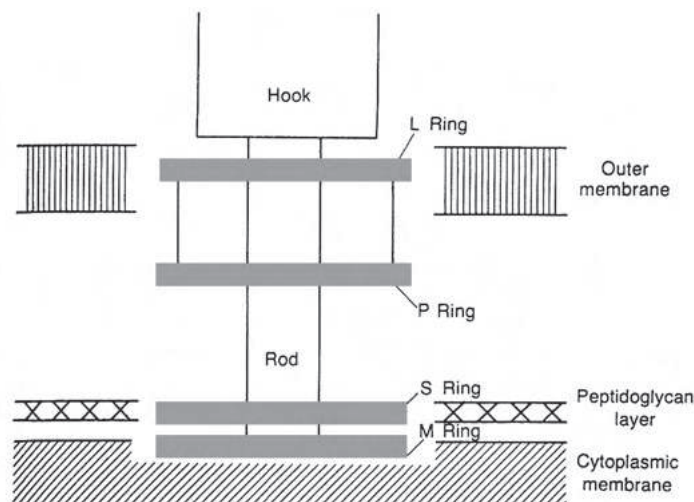

Fig. 1.35 (b) : A model showing the possible topological relations between the basal structure of the flagellum and the outer cell layers of *E. coli*. After M. L. De Pamphills and J. Adler, "Attachment of Flagellar Basal Bodies to the Cell Envelope," *J. Bacteriol.*, **105**, 396 (1971).

1.9.7.10 Fimbriae (Pili)

Some surface appendages found in bacteria other than flagella which are straight, numerous, less rigid and thinner. Such appendages are called fimbriae. Though they are the characteristic structure of Gram negative bacteria but rarely in Gram positive bacteria may their occurrence be observed e.g. *Corynebacterium renale*. They are usually much more numerous than flagella. The length of fimbriae varies from 0.2 - 20 μm and width from 30A to 140 A. Ottow (1975) classified fimbriae into six groups. Group 1 fimbriae serves as adhesive organelles and these are peritrichously arranged. Group 2 fimbriae are called sex pili since they form conjugation tube through which gene transfer occurs. Sex pili are made up of pilin protein encoded by sex factor or episome. Therefore, group 2 fimbriae are called pili but all fimbriae are not pili since they are not involved in the process of conjugation. Group 3 fimbriae are found in *Agrobacterium* and their specific function is unknown. In *Pseudomonas* and *Vibrio* Group 4 type o fimbriae are observed which help in the bacterial motion. Group 5 fimbriae are found in *Rhizobium lupini* which help in the process of clustering the competent cells to promote the conjugation process. In Group 6 fimbriae the filaments have antigenic property.

Function of Fimbriae (pili) :

- i) Fimbriae provide adhesive property to the bacterial cells.

- ii) In some bacteria fimbriae have antigenic property.
- iv) Fimbriate bacteria form a pellicle layer due to the adhesive property of fimbriae and cell to cell coordination could be possible through formation of such layer. Fimbriae also facilitate the formation of biofilm.
- v) Sex pili help the transfer of genetic materials from a donor to recipient cell by formation of conjugation tube in between.

1.9.7.11 Glycocalyx

Glycocalyx is a general term used to denote the network of polysaccharides extending from the surface of bacteria. It could encompass both **capsule** and **slime layer**. When polysaccharide materials are so highly organised that it could not be easily washed off, then it is called capsule. When it is diffused, unorganized material and could be easily washed off, then it is called slime layer. Though bacterial capsule is made up of polysaccharide in majority, rarely it is constituted of amino acid. In *Bacillus anthracis*, it is made up of Poly D- glutamic acid. Capsule could be observed under light microscope using negative stain or capsule specific stain. The capsule and slime layer in bacteria has the following functions:

- i) Capsule layer has anti phagocytic property and prevent bacteria cells to be phagocytosized

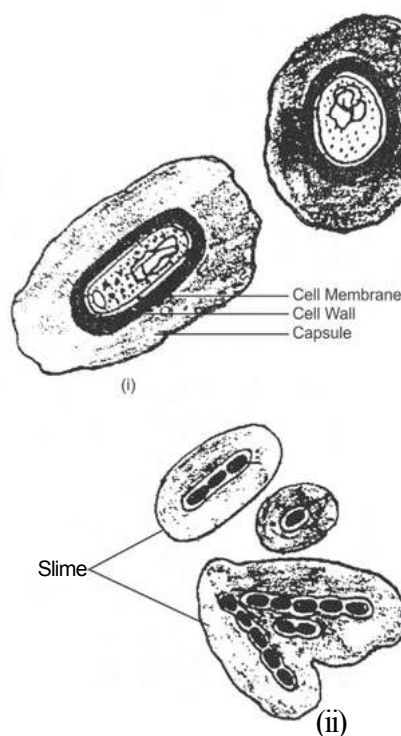

Fig. 1.36 : Bacterial slime layer and capsule.

by host phagocytes .ii) Capsule protects bacteria against desiccation.iii) It helps to attach bacteria on host surface to establish permanent host -parasite relationship. iv) In gliding bacteria slime layer helps in the mobility. v) Capsule layer has some fixed charge or ions on its surface which develop some repulsive force among similar bacteria in aquatic environment, such repulsive force helps the bacteria to remain in suspension. **(Fig. 1.36).**

In some Gram positive and Gram negative bacteria a paracrystalline surface structure similar to floor tiles in appearance are observed which are made up of proteins and glycoproteins. Such structures are called **S-Layer**. This layer is very common in occurrence in Archaea. In Gram negative bacteria S-layer is associated with the outer membrane and in Gram positive bacteria it remains attached on the surface of peptidoglycan. This layer helps to maintains shape and size of the bacterial cell. It protects the cell to withstand the environment with P^H fluctuation, osmotic stress, harmful enzymes etc. S- Layer can promote cell adhesion to the host surface. It provides virulent property to the cell by imparting antiphagocytic property on it.

1.10 □ Economic importance of Bacteria

Bacteria are applied in different field of human welfare. They could be exploited in industry, medicine, agriculture and to resolve different environmental issues. The major field of applications are discussed below:

a) Use of bacteria in food production: Bacteria are used in production of fermented milk products. The souring and curdling of milk by lactic acid bacteria is very common example of application in our everyday life. With the aid of fermentation technique using starter organism such as *Streptococcus salvaricus* sub sp. *thermophilus* and *Lactobacillus delbruckii* sub sp. *bulgaricus* **Yoghurt** is produced. **Kefir** , a fermented milk is produced by a mixed lactic acid bacteria(*Lactobacillus kefir*) and alcoholic yeast. In European country a milk product known as **Koumiss** is produced by using lactose fermenting bacteria *L. delbruckii* sub sp *bulgaricus*. Lactic acid producing bacteria such as *Leuconostoc citrovorum*, *Streptococcus cremoris* etc. are used in the production of **butter**. Milk organisms produce a small amount of acetoin which is spontaneously oxidized to diacetyl. This substance imparts characteristic flavour and aroma to butter and similar products. Two bacteria such as *Leuconostoc mesenteroides* and *Streptococcus faecalis* is used in the production of **Idli** - a fermented food product made from rice and black gram. In the ripening of **Natto** (a soybean made product) *Bacillus natto* is applied.

b) Use of bacteria in industry: In different industry bacteria are used to obtain commercially important products. 1) **Enzyme production:** There are large numbers of

bacteria which produce a variety of enzymes through fermentation process. Some important enzymes and their producer organisms are enlisted below:

Name of the Bacterial enzyme	Name of the	Major uses
1. <i>Bacillus coagulans</i>	Alpha amylase	Used in the preparation of digestive tonic, in the production of paper sizing, in the production of glucose from starch.
2. <i>Bacillus licheniformis</i>	Microbial protease.	Used in the preparation of good quality detergent, substitute of calf rennet, bating, tenderization of meat etc.
3. <i>Pseudomonas fluorescens</i> , <i>Bacillus subtilis</i> , <i>E. coli</i>	Cellulase	It is used in commercial food processing in coffee. Cellulases are used widely in textile industry and laundry detergents.

2) **Medicine:** With the advent of fermentation technology a large number of antibiotics have been discovered using different microbial strains. Antibiotics produced by bacteria have been very useful for cure of certain human diseases caused by microorganisms. Some important antibiotics with their producer microorganisms and applications are given below:

Bacteria	Antibiotics	Application
<i>Bacillus brevis</i>	Tyrothricin	Mouth and throat infection
<i>B. polymyxa</i>	Polymyxin B	UTI and gastroenteritis
<i>B. subtilis</i>	Bacitracin	Dermatitis, superficial pyogenic infection, dysentery.
<i>Streptomyces griseus</i>	Streptomycin	Tuberculosis
<i>S. erythreus</i>	Erythromycin G	Cholera, Tetanus, arthritis
<i>S. noursei</i>	Nystatin	Skin lesion
<i>S. aureofaciens</i>	Tetracyclines	Cholera, Tetanus

Nowadays with the advent of Biotechnological technique antibody producing gene against a particular pathogen is inserted into the bacterium which can infect potato leaf segment. Such leaf segments are allowed to sprout into whole plants carrying gene for antibody. Eating of potato triggers immune response to pathogen. Another achievement in the field of medicine is the artificial production of human insulin. DNA from human pancreas cell is isolated and inserted into the bacterial plasmid to produce recombinant DNA. Now the bacterial cell is transformed with the recombinant plasmid and such transformed cell line is allowed to grow in fermentation medium. During growth such recombinant cell line will produce the insulin which could be recovered from fermentation medium. Bacteria could be used as probiotics to keep our body healthy and fit. The most commonly used probiotic bacteria are *Lactobacillus acidophilus*, *L. rhamnosus*, *Bacillus coagulans*, *Bifidobacterium bifidum* etc. Bacterial toxins are used in the preparation of vaccines. Small doses of such toxins are injected into the blood of the animals like horse. To inactivate the poison the immune system of the injected animal produces antibodies. The serum with antibody is isolated from the animal which is used as weapon to combat diseases caused by bacteria. Besides, bacteria could be used in the production of vitamin B by fermentation of sugars and starch. *Clostridium acetobutylicum* is the bacterium which is used in such purpose to produce vitamin B in commercial scale.

3) **Alcohol production:** Many bacteria can produce ethanol as the major fermentation product from carbohydrates. Some commonly used alcohol producing bacteria are *Clostridium acetobutylicum*, *Klebsiella pneumoniae*, *Leuconostoc mesenteroides*, *Sarcina ventriculi*, *Zymomonas mobilis*.

4) **Production of organic acids :** Bacteria are used for production of different types of organic acids such as vinegar or acetic acid, citric acid, lactic acid etc. Vinegar production is a two step process. In the first step yeast converts sugar to ethanol anaerobically. In the second step ethanol is aerobically oxidised to acetic acid by *Acetobacter* and *Gluconobacter*. Vinegar is used in cleaning, washing hair, preserving food, improving skin function and different recipes. Lactic acid produced as a byproduct of bacterial fermentation (e.g. *Lactobacillus delbrueckii*, *L. bulgaricus*, *L. pentosus* etc.) is used in different way. Calcium lactate is used in baking powder. Lactate provides acidity in foods and beverages and serves as preservatives in food stuff. In textile, laundry and in leather industry lactate is used significantly. Economically important citrate could also be produced by using bacteria like *B. Subtilis*, *B. licheniformis*, *B.flavum* etc.

5) **Retting of jute fibre:** Retting is a process by which fibre is separated from the stem due to hydrolysis of pectic substances in the cell wall. To enhance the process fibre

yielding plants are immersed in water and after being swelled bacterial activity starts to separate fibre from stem through retting. These separated fibres are used to make rope, sacks etc. Bacteria such as *Clostridium butyricum* are used for retting of jute, hemp and flax.

6) **Tanning of Hides and skins:** During the process of tanning the action of bacteria are very important in the conversion of hides and skins to leather.

c) **Role of Bacteria in agriculture:** Bacteria play immense role in agriculture through exerting their effects to improve soil fertility as well as crop protection. Bacteria act on complex organic substances and convert them into simpler inorganic forms. The proteins present in dead plants and animals are converted to ammonia by different ammonifying bacteria and such process is known as **ammonification**. Both free living and symbiotic bacteria can fix atmospheric nitrogen to the soil in the form of nitrate which is absorbed by the root system of plants and such nitrate used in the synthesis of proteins by reduction called nitrate reduction. Atmospheric nitrogen is fixed in the bacterial cell in the form of ammonium which is directly utilized by the cell itself for the synthesis of amino acids by its incorporation into keto acids. Excess ammonium is released outside the cell and ammonium produced by ammonification is oxidised to nitrite with the help of soil inhabiting bacteria *Nitrosomonas*. The nitrite again oxidised to nitrate by *Nitrobacter*. The conversion of ammonium to nitrate is known as **nitrification**. The key enzyme responsible for conversion of nitrogen to ammonium is known as nitrogenase. By virtue of having this enzyme bacteria are used in the production of biofertilizer which is basically microbial inoculants applied in the agricultural field to enhance soil fertility. *Rhizobium leguminosarum*, *Azotobacter vinelandii*, *Azospirillum* inoculants are now being used as biofertilizer as a substitute of chemical fertilizer.

Bacillus thuringiensis is widely distributed bacterium which produces several toxins having insecticidal properties. Therefore, this it is used as a biocontrol agent against insects and pests. Commercially available biopesticides in the market are produced from this bacterium. In agricultural field bacteria exert benefits not only by increasing soil fertility but also by increasing nutrient availability to the crops. Bacteria produce phosphate solubilising extracellular enzymes by which insoluble phosphates get solubilised into available form in the soil. Exerting antagonistic effects in the rhizosphere region bacteria protect root system of plants from pathogenic attack.

a) **Role of bacteria in Genetic engineering:** In genetic engineering bacteria are used as a source of vector for carrier of desired genes. The plasmid present in the bacteria is used as vector for gene insertion. The gene integrated vector or

chimeric vector can be used as cloning vector or expression vector. The former is used to multiply the gene of interest whereas the latter is used to express the desired gene inside the host where such gene is absent.

- b) Role of bacteria in Digestion:** Herbivorous animals take cellulose as their major source of energy. Such cellulosic materials are digested in the gut with the help of a bacteria *Ruminococcus spp.* This bacterium secretes cellulose enzyme that helps to digest cellulose. *Escherichia coli* form a part of human intestinal microbiota. It helps to synthesize vitamin B12 in human intestine and also helps in the process of digestion.
- c) Curing of tobacco and tea :** Bacteria are useful in curing and ripening of tobacco leaves. Bacteria like *Micrococcus*, *Bacillus megaterium* etc. are applied during preparation of tea leaves to improve their characteristic colour and aroma. To cure off the bitterness of coffee and cocoa such bacteria are employed.
- d) Disposal of sewage:** Bacteria help in environmental sanitation by disposing off the sewage by decomposition. Bacteria have different enzymes by which they can cause decomposition of sewage. Contamination of sea water with petroleum hydrocarbon could be managed by bacteria. *Methylocella silvestris*, *Pseudomonas putida*, *Micrococcus roseus*, *Flavobacterium sp.* etc are examples of bacteria which can degrade crude oil by their metabolic activity and thus potentially could be used in remediation.
- e) Production of fuel:** Bacteria involve in anaerobic digestion of organic substances and produce gases collectively known as biogas. Methanogens like *Methanobacterium formicum*, *M. thermoautotrophicum*, *Methanococcus* etc. are thus used as bio energy resources.
- f) Microbial leaching:** Microbial leaching is a process by which metals are dissolved from ore bearing rocks using microorganisms. Thus bio mining has emerged as an important branch of biotechnology in recent years. The most commonly used microorganisms for bioleaching are *Thiobacillus thiooxidans*, *T. ferrooxidans*, *Bacillus licheniformis*, *B. megaterium*, *B. polymyxa* etc.
- g) Harmful effects of bacteria:** Besides immense economic role, there are so many bacteria which are harmful. The harmful effect of bacteria is due to their involvement in food spoilage and food poisoning. Many saprophytic bacteria cause the rotting of vegetables, fruits, meat bread etc. Bacterial toxins when contaminate with human food it causes nausea, vomiting, abdominal discomfort,

diarrhoea and even death. The common food poisoning bacteria are *Clostridium botulinum*, *Staphylococcus aureus*, *Salmonella enteritis* etc. Some denitrifying bacteria like *Thiobacillus denitrificans*, *Micrococcus denitrificans* etc. convert soil nitrates and ammonia into free nitrogen and thus reduce fertility of soil. Bacteria are also responsible for causing a wide variety of plant diseases and thus bring about huge economic loss. About 90% of human diseases are caused by bacteria. Some of them are enlisted below:

Sl. No.	Name of the bacteria	Diseased cause
1.	<i>Staphylococcus aureus</i>	Wound infection, boils, food poisoning, and mastitis.
2.	<i>Streptococcus pyogenes</i>	Scarlet fever, rheumatic fever, strep throat etc.
3.	<i>Salmonella spp.</i>	Salmonellosis, typhoid fever etc.
4.	<i>Bacillus anthracis</i>	Anthrax
5.	<i>Mycobacterium tuberculosis</i>	Tuberculosis
6.	<i>Shigella dysenteriae</i>	Shigellosis (Bacterial dysentery)
7.	<i>Yersinia pestis</i>	Plegue
8.	<i>Treponema pallidum</i>	Syphilis
9.	<i>Rickettsia sp</i>	Rocky mountain spotted fever

1.11 □ Summary

Viruses are ultramicroscopic. They are inert outside a living host cell. Tobacco Mosaic Virus (TMV) is a plant virus which has a helical symmetry. Bacteriophage T₂ is a DNA virus and it is a lytic virus. Lytic cycle has the following phases : Absorption, Penetration, Replication and transcription, Assembly and Release. Bacteriophage λ (lambda) is a lysogenic phage that forms prophage by integrating into the host chromosome. Phage induction is a method by which the integrated λ chromosome is excised from host chromosome. Viruses are important plant, animal and bacterial pathogens. They are used as vectors in gene therapy. Bacteria are of three basic shapes — Cocci, rods and bacilli. They grow in geometric progression and growth is population growth. Genetic recombination of bacteria

takes place by three methods — Transformation, Conjugation and Transduction. Phage mediated transduction is either generalized or specialized. Structurally bacteria are of two types – gram positive and gram negative. This difference is based on their cell wall characteristics. They have two types of extracellular appendages — flagella and pili. Bacteria are decomposers in energy transfer cycle of nature. They are also used in many beneficial ways for humankind. Many are also potent plant and animal pathogens and cause some important human diseases.

1.12 □ Exercises

Objective multiple choice type questions

1. Who discovered porcelain filter? - a) Louis Pasteur b) Mayer c) Charls Chamberland d) Dimitri Ivanovski.
2. Who first crystallized the TMV? – a) M. Stanley b) F.W. Twort c) Beijerinck d) F.C. Bawden.
3. Who discovered cyanophage? – a) Safferman & Morris b) L. Montagnier c) Fraenkel-Conrat d) Hershey and Chase.
4. Satellite virus was discovered by – a) Kassanis b) Harshey and Chase c) Safferman and Morris d) Gierrer and Schramm.
5. Who discovered HIV? – a) Kassanis b) L. Montagnier c) Diener and Raymer. d) None of the above.
6. Pox virus is – a) Bullet shaped b) Brick shaped c) Filamentous d) Spheroid.
7. Bacteriophage M13 is a _____ shaped virus. (Fill in the blank)- a) Filamentous virus b) bullet shaped virus c) cuboid virus d) coiled virus.
8. TMV is a - a) Helical virus b) Polyhedral virus c) Complex virus d) Filamentous virus.
9. T4 bacteriophage is a - a) Helical virus b) Polyhedral virus c) Complex virus d) Rod shaped virus.
10. Which of the following viruses was first used by Edward Jenner in vaccination? - a) Vaccinia virus b) T4 c) Rabies virus d) ϕ X174
11. Which of the following viruses has insecticidal property? – a) T4 b) T2 c) NPV (Nuclear Polyhedrosis virus) d) CMV

12. Who is called father of Microbiology? – a) Anton Van Leeuwenhock b) Robert Koch c) Louis Pasteur d) Edward Jenner.
13. Who first observed Archaea as new life form? – a) Lederberg and Tatum b) Carl Woese c) Robert Koch d) Winogradsky.
14. Who first discovered *Bacillus anthracis*?- a) C. Gottfried b) Louis Pasteur c) Robert Koch d) Winogradsky.
15. The antibiotic Nystatin is obtained from: a) *Streptomyces griseus* b) *S. erythreus* c) *S. noursei* d) *Bacillus brevis*.
16. The antibiotic tetracycline is obtained from: a) *Streptomyces aureofaciens* b) *S. erythreus* c) *B.subtilis* d) *S. griseus*.
17. Which of the following bacteria is used in retting of jute fibre? a) *Clostridium butyricum* b) *Zymomonas mobilis* c) *Clostridium acetobutylicum* d) *Bacillus licheniformis*.
18. Which species of Bacillus is used as biopesticide?- a) *Bacillus subtilis* b) *B. thuringiensis* c) *B. megaterium* d) *Azotobacter vinelandii*.
19. Which of the following bacterium is used in the production of butter milk?- a) *Lactobacillus delbruckii* b) *Leuconostoc mesenteroides* c) *L.citrovorum* d) *Streptococcus faecalis*.
20. Proteinaceous glycoalyx is found in which of the following bacterium? –a) *Bacillus subtilis* b) *B. licheniformis* c) *B. anthracis* d) *B. megaterium*.

Answers: 1(c), 2(a), 3(a), 4(a), 5(b), 6(b), 7(a), 8(a), 9(c), 10(a), 11(c), 12(a), 13(b), 14(c), 15(c), 16(a), 17(c), 18(c),19(c),20(c).

Answer the following questions

1. Write the salient features of viruses. (Ans. See section 1.3.0)
2. What is phage therapy? (Ans. See section 1.3.1)
3. Draw and describe the structure of a TMV virus. (Ans. See section 1.4.1)
4. Draw and describe the structure of a typical complex virus. (Ans. See section 1.4.2)
5. Classify viruses on the basis of their nucleic acid composition. (Ans. See section 1.5.0)

6. Write the mechanism of penetration of virus into the host bacterial cell. [Ans. See section 1.6.1(b)]
7. Comment on the mechanism of transcription of viral genome within host cell [Ans. See section 1.6.1(c)]
8. Write the mechanism of prophage formation. [Ans. See section 1.6.2]
9. What is phage induction? (Ans. See section 1.6.2)
10. Write short notes on: a) Role of viruses in vaccine production.[Ans. See section 1.7.0(a)] b) Role of viruses in gene therapy [Ans. See section 1.7.0(b)] c) Role of viruses in disease diagnosis [Ans. See section 1.7.0(j)] d) Application of viruses in control of insect and pests [Ans. See section 1.7.0(d)].

Answer the following questions in brief

1. What are pleomorphic bacteria? (Ans. See section 1.9.1)
2. What are photolithotrophs? (Ans. See section 1.9.2)
3. What are mixotrophs? (Ans. See section 1.9.2)
4. Which organelle is involved in the process of binary fission? (Ans. See section 1.9.3)
5. Define generation time. (Ans. See section 1.9.3)
6. Distinguish between natural and artificial transformation. (Ans. See section 1.9.5.1)
7. Distinguish between generalised and specialised transduction. (Ans. See section 1.9.5.2)
8. Distinguish between plasmid and episome. (Ans. See section 1.9.5.3)
9. What is meant by Hfr? (Ans. See section 1.9.5.3)
10. What is merozygote? (Ans. See section 1.9.5.3)
11. Name one spherical endospore producing bacterium. (Ans. See section 1.9.6)
12. Name one secondary wall component in Gram positive bacterium (Ans. See section 1.9.7.1)
13. What are bacteriocins? (Ans. See section 1.9.7.8)

Write short notes on the following

1. The structure of outer membrane in bacteria. (Ans. See section 1.9.7.2)
2. The chemical composition of murein . (Ans. See section 1.9.7.1)
3. Granular inclusions in bacterial cell. (Ans. See section 1.9.7.6)
4. The types of plasmid found in bacteria. (Ans. See section 1.9.7.8)
5. The ultra structure of bacterial flagella. (Ans. See section 1.9.7.9)
6. Bacterial fimbriae and its function. (Ans. See section 1.9.7.10)
7. The ultra structure of glycocalyx and its function. (Ans. See section 1.9.7.11)
8. Role of bacteria in agriculture. [Ans. See section 1.10(c)]
9. Bacteria in food production . [Ans. See section 1.10(a)]
10. Medicinal importance of bacteria. [Ans. See section 1.10(b)]

Unit 2 □ **Algae**

Structure

2.0 Objective

2.1 Introduction

2.2 General Characteristics of algae

2.3 Range of thallus organization in algae

2.4 Morphology and life cycle of *Nostoc*

2.4.1 Reproduction

2.4.2 Vegetative reproduction

2.4.3 Systematic Position

2.5 Morphology and Life cycle of *Oedogonium*

2.5.1 Morphology of the filament

2.5.2 Cell structure

2.5.3 Reproduction

2.6 Systematic Position

2.7 Morphology and life cycle of *Polysiphonia*

2.7.1 Structure of thallus

2.7.2 Reproduction

2.8 Economic importance of algae

2.8.1 Algae as food

2.8.2 Agar agar

2.8.3 Carrageenin

2.8.4 Alginates

2.8.5 Funori

2.8.6 Use of algae as fodder

2.8.7 Role of algae as biofertilizer

2.8.8 Diatomite

2.8.9 Role of algae in the production of medicine

2.8.10 Role of algae in sewage disposal

2.8.11 Role of algae in land reclamation

2.8.12 Industrial importance of algae

2.8.13 Negative aspects

2.9 Summary

2.10 Exercises

2.0 □ Objective

From this unit you will be able to learn about the variations found in types, structure and reproduction of algae. You will also be able to learn their importance in ecosystem.

2.1 □ Introduction

Among the thallophytic plants algae constitute a very important group. They are aquatic autotrophic most primitive thallophytes having wide range of diversity in respect of thallus organization, mode of reproduction, and habitat. Their variability in terms of pigment constitution is so prominent that they have been classified and categorised into different groups like blue green algae, green algae, brown algae, red algae etc. They are not only important due to the evolutionary aspect but also important for their agricultural, industrial and ecological values. The learning an objective of this module is to provide a general idea about the diversity of the thallus organization found in the different classes algae. The learners would understand the structural morphology, reproduction and life cycle of the different genera of this group. They would be able to distinguish between the life cycle patterns of different genera. They would learn how algae could be applied in human welfare.

2.2 □ General Characteristics of algae

The salient features of algae are as follows:

- a) **Habit and Habitat:** Algae constitute a large group of thallophytic cryptogamic plant. It has about 1560 genera and 17535 species. Members are mostly aquatic but their occurrence is wide and variable. The terrestrial members include *Fritschiella*, *Chlorella*, *Vaucheria* *Phormidium* etc. Some are lithophytes and can grow on the moist surface of rocks and stones (e.g. *Batrachospermum*,

Enteromorpha etc.). *Dunaliella*, *Chlamydomonas ehrenbergii* etc can tolerate high salt concentration and are halophytes. Their occurrence can be found near hot spring where normal life is not possible e.g. *Heterohormogonium*. Some algae can grow at very low temperature even on the ice bed and due to their excessive growth red snow formation may occur. *Chlamydomonas nivalis*, *Ulothrix flaccida* etc. are red snow forming algae. Some are epiphytes (*Rhodymania pseudopalmata*), some are endophytes (*Anabaena azollae* grows inside the fronds of *Azolla*) and some are epizoic (*Cladophora crispata* grows epizoically on the shells of molluscs). *Chlorella* is an example of endozoic algae that grows in *Hydra*. *Cephaleuros parasitica* is a parasitic alga which grows on the tea leaves and causes a disease known as red rust. Some common algal phytoplanktons are species of *Malosira*, *Pinnularia*, *Nitzschia*, *Euglena* etc.

- b) **Thallus:** Algal thallus may vary from a single unicellular microscopic (*Chlamydomonas*) form to giant macroscopic structure. *Macrocystis pyrifera* is considered as longest alga that could attain a length of 700 feet. The unicellular forms may be motile or non motile.
- c) **Cell wall:** Each algal cell is bounded by a cell wall which is made up of pectin, cellulose, chitin algin and fucoidin etc. In some genera cell wall is associated with iorganic substances like calcium, silica and magnesium carbonate.

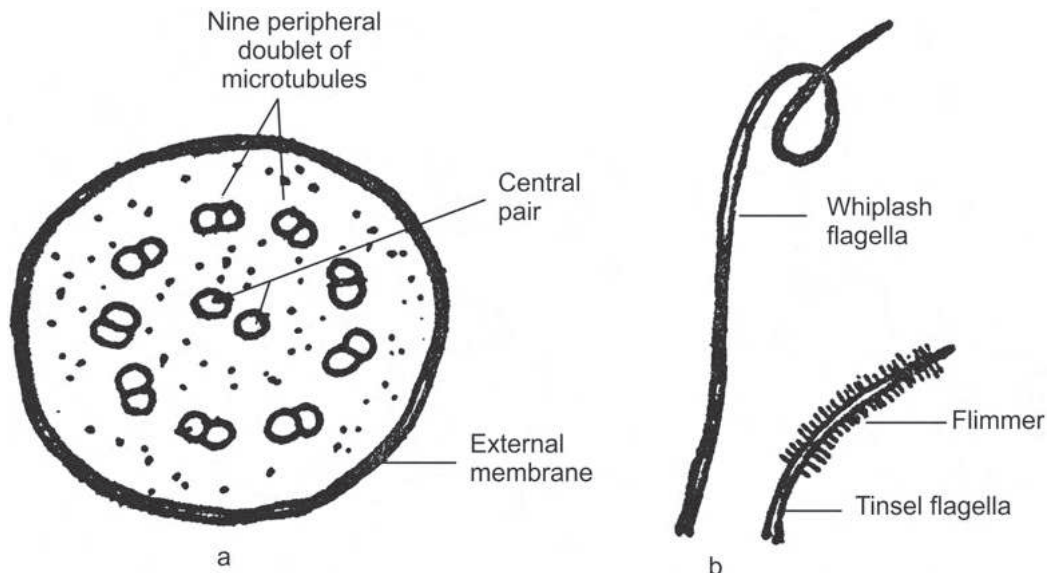

Figs. 2.1. (a) Ultrastructure of algal flagella ; (b) Morphology of different types of flagella in algae.

- d) **Algal flagella:** In motile form flagella are present which may remain attached to the cell apically or laterally or at the posterior end of the vegetative cell. Flagella may be whiplash (smooth or without any surface projection) or tinsel (having short thin surface appendages making the flagella featherlike appearance) type. Internally flagella show typical 9+2 arrangement i.e. flagella consist of two central tubules surrounded by nine peripheral tubules (**Figs. 2.1**).
- e) **Cytoplasm:** The cytoplasm of eukaryotic algae contain all cellular organelles like mitochondria, contractile vacuoles, chloroplast, nucleus, pyrenoids etc. except in prokaryotic form like Blue green Algae (BGA) where the structures like mitochondria, golgibodies, endoplasmic reticulum and a definite nucleus are absent. The common pigments present in the cell are chlorophyll-a, chlorophyll-b, β carotene and xanthophylls though the combinations of different types of pigments are variable in different class.
- f) **Reserve materials:** Starch is the principal reserve material in algal cell. Fats and oils are present in the members of Bacillariophyceae, Dinophyceae and Xanthophyceae. Laminarin and mannitol are the reserve food of the members of Phaeophyceae. In Rhodophyceae the characteristic reserve materials are Floridian starch, floridoside and mannoglycerate. Cyanophycean starch is the principal reserve material in Cyanophyceae. Sitosterol is the main sterol in the members of Chlorophyceae whereas fucosterol is present in Bacillariophyceae, Rhodophyceae and Chrysophyceae.
- g) **Reproduction:** Three different types of reproduction are found in algae such as vegetative, asexual and sexual.
- h) **Vegetative reproduction:** Reproduction by vegetative means takes place by fragmentation, fission, akinete, tuber, hormogonia and formation of adventitious thalli. In the process of fragmentation, the mother filament is separated into many fragments by mechanical force and each fragment gives rise to a new filament. In Diatom (Bacillariophyceae) the cell divides like bacteria following the process called binary fission and increase the number of cells in the population (**Fig. 2.2**). In *Anabaena*, *Nostoc* etc. a thick walled non motile body called akinete is formed as a modification of vegetative cell. The latter is rich in reserve materials and germinates under favourable condition to give rise to a new individual filament. In the underground part of *Chara* tubers are found which serves as organ vegetative propagation. Hormogonia are short segment of a filament produced as a result of the formation of separation disc in the filament. It is found in the

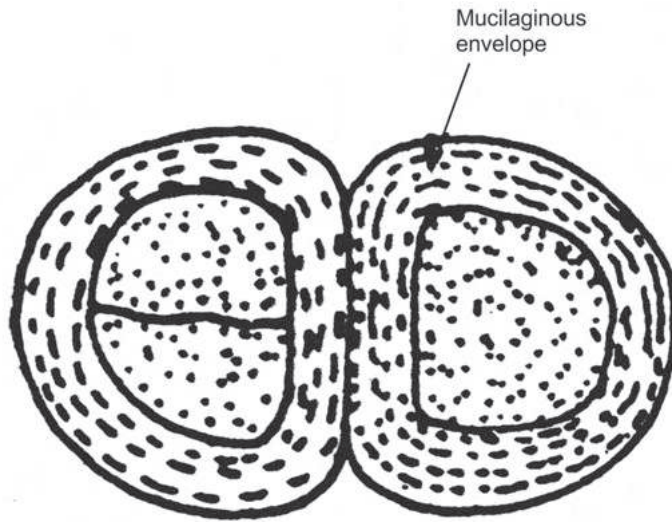
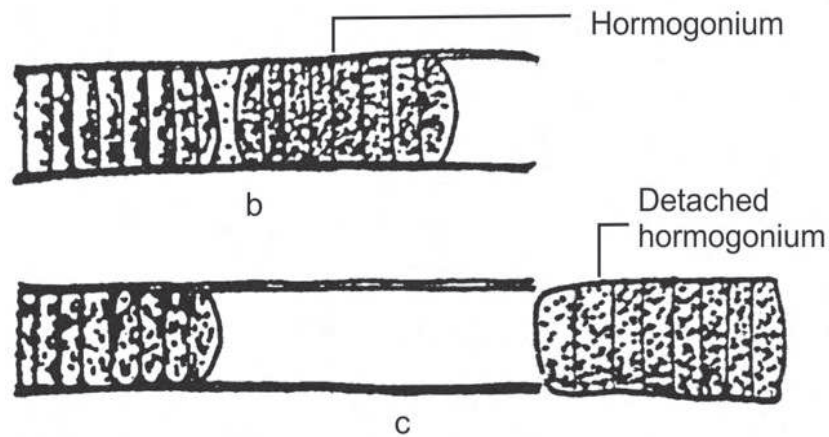

Fig. 2.2 : Vegetative reproduction by binary fission.

members of Myxophyceae. (Fig. 2.3). Adventitious thalli are produced by algae like *Fucus*, *Dictyota* etc. Such thalli are detached and give rise to new thalli.



Figs. 2.3 : Formation of hormogonium in Cyanophyceae.

- i) **Asexual reproduction:** Asexual reproduction in algae takes place by production of different types of spores. Most common form of spore is zoospore which is flagellate and produces inside a spore sac called zoosporangium. The zoospores may be biflagellate (e.g. *Chlamydomonas*) or multiflagellate (e.g. *Oedogonium*). In *Vaucheria* (Xanthophyceae) a typical multinucleate and multiflagellate zoospore is produced which is called synzoospore. A non-motile thin walled zoospore is

formed by the members like *Vaucheria*, *Chlamydomonas* etc. such spore is called aplanospore. Hypnospore is a thick walled aplanospore produced by *Vaucheria*. In *Chlorella*, *Oocystis* etc. a special type of thin walled spore is produced as a result of cell division which is similar to that of the mother cell and such spore is called autospore. (Figs. 2.4)

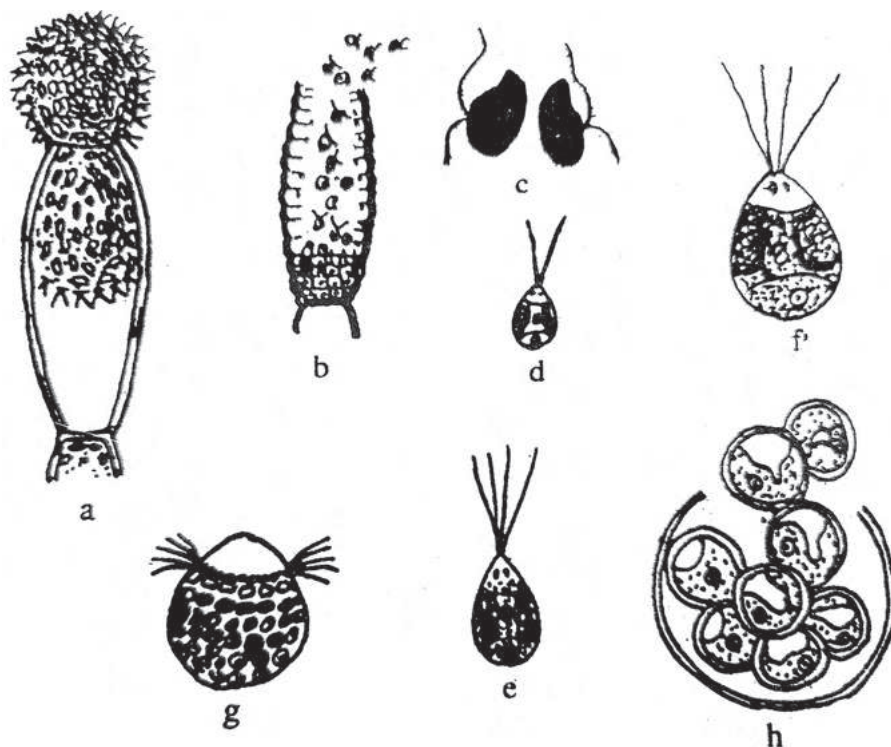

Figs. 2.4 : Different types of zoospore in algae. Biflagellate zoospore (a–d), Quadriflagellate zoospore (e, f), Multiflagellate zoospore (g), Non motile zoospore (h).

- j) **Sexual reproduction:** Sexual reproduction takes place by **isogamy, anisogamy and oogamy**. In isogamy the fusing gametes are morphologically similar e.g. *Chlamydomonas eugametos*. In *Spirogyra* the gametes are immobile mass of cytoplasm. Such gametes are fused with each other by the process called conjugation. When the fusing gametes are morphologically different i.e. one is smaller and the other is larger, such gametes are called anisogametes and the process of fusion is called anisogamy (e.g. *Chlamydomonas braunii*). In oogamy the fusing gametes are not only morphologically different but they also show behavioural differences. The smaller male gamete is motile whereas the larger female gamete is non motile. The fusion between the gametes produces diploid oospore. The gametes are produced inside specialised structures called

gametangia. In case of oogamous reproduction the gametangia are morphologically distinguishable as male and female gametangia. The degree of complexity of gametangia varies greatly. The most complex type of gametangium is found in *Chara*. The male sex organ in *Chara* is called globule and the female is known as nucule. (Figs. 2.5)

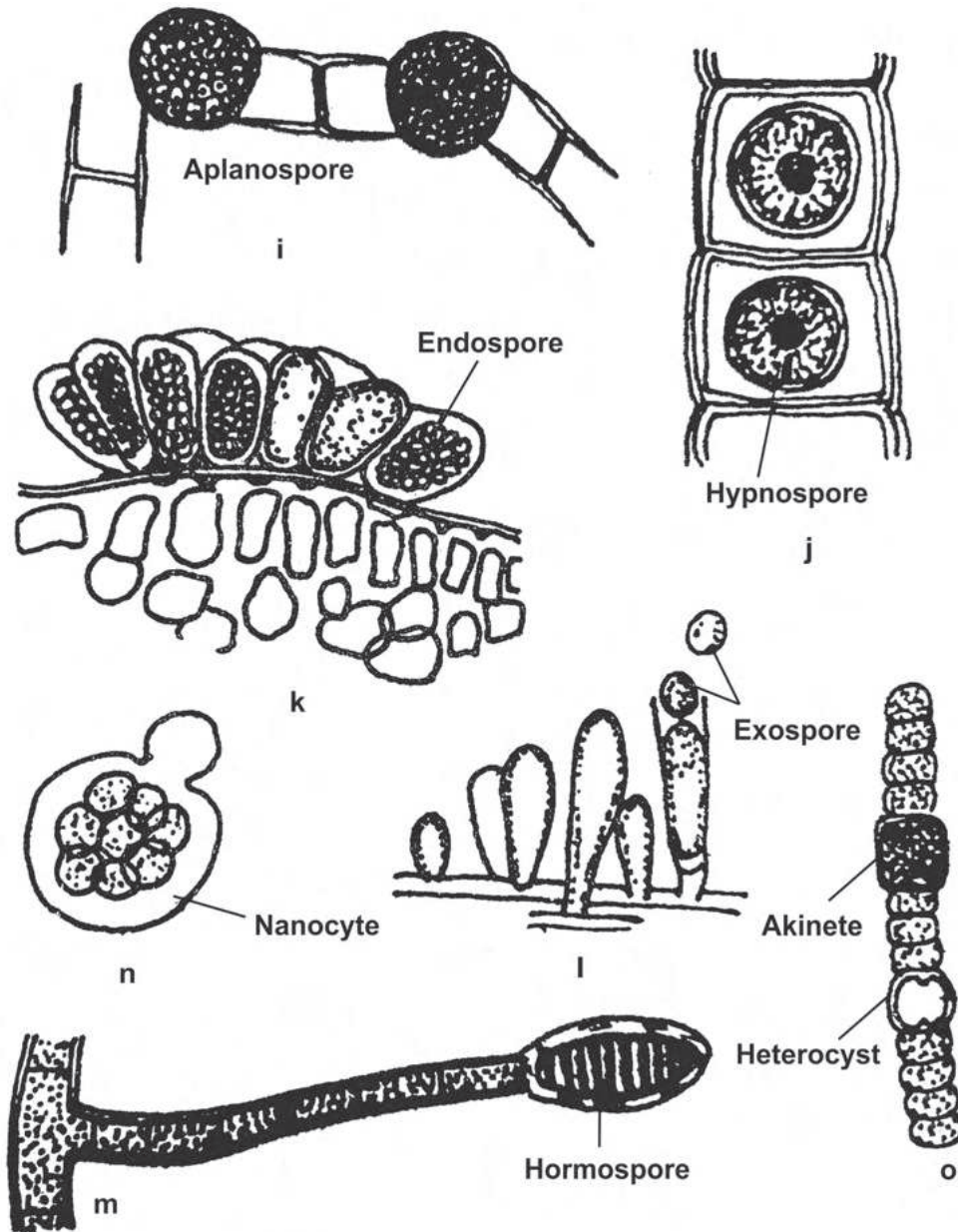

Figs. 2.5 : Different form of asexual spores in the members of algae (i-o)

- k) **Life cycle pattern:** The life cycle pattern in algae is variable. In the life cycle haploid and diploid phase repeats in a cyclic manner and such repetition is called alternation of generation. There are five different types of alternation of generation found in algae, such as haplontic, diplontic, diplohaplontic, haplobiontic and diplobiontic. In **haplontic** life cycle the haploid phase is predominant and the diploid phase is represented only by zygote. Here, the plant body is haploid. The gametes produced by the gametangia are also haploid. The haploid gametes are fused to form diploid zygote which undergoes meiosis to return further into haplophase called meiospores or meiozoospores. The latter germinates to give rise to the new haploid individual. This pattern of life cycle is found in the members of Chlorophyceae (**Word diagram 2.1**). The **diplontic** life cycle is characterised by the predominance of diploid phase in the life cycle. Here the plant body is sporophyte and diploid. It bears diploid gametangia where gametes

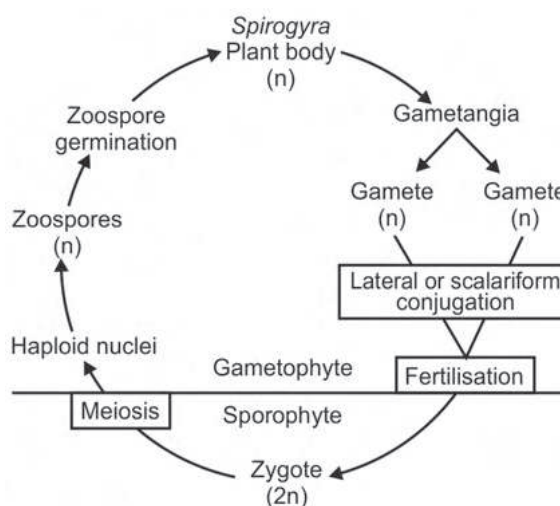

Word Diagram 2.1 : Haplontic life cycle (*Spirogyra*)

are produced as a result of gametogenic meiosis. The gametes thus produced undergo sexual union to form zygote (2n). Zygote germinates directly to form new individual and during germination no meiosis occurs. This type of life cycle is exhibited in many diatoms (**Word diagram 2.2**). In **diplohaplontic** life cycle pattern both the haploid and diploid phase is equally dominant. The diploid phase is known as sporophyte and the haploid phase is known as gametophyte (**Word diagram 2.3**). The sporophytic phase produces sporangia from which spores are formed as a result of reduction division. Spores germinate to give rise to the haploid gametophyte. The gametophyte bears sex organs from which

gametes are produced. The gametes of opposite sexuality fuses to form zygote. The zygote thus produced undergoes mitotic division and form diploid sporophytic

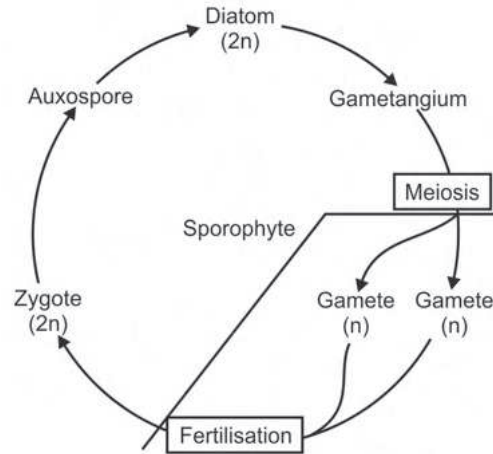

Word Diagram 2.2 : Diplontic life cycle (Diatom)

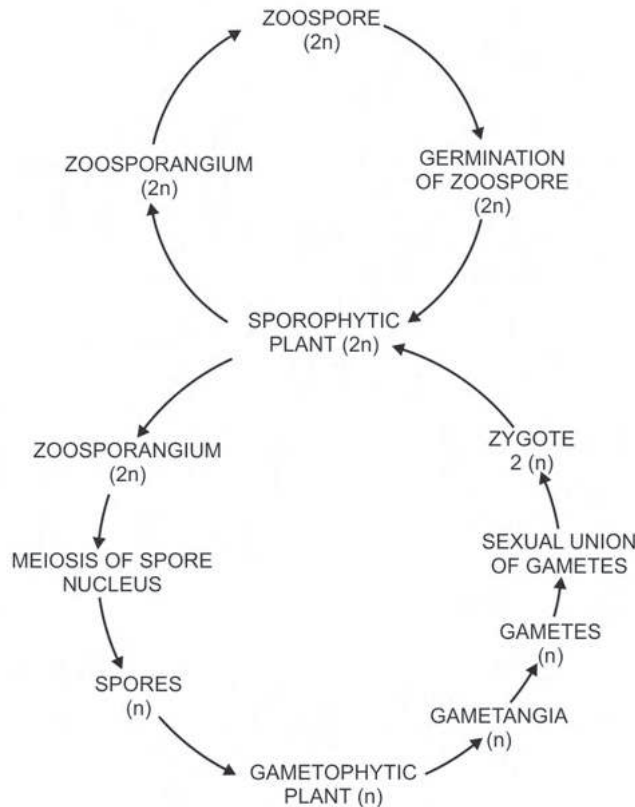

Word Diagram 2.3 : Diplohaplontic type of cycle of algae.

phase of the life cycle. Here the alternation of generation has been divided into two types. Where the gametophytic and sporophytic phases are morphologically similar such alternation of generation is designated as **isomorphic** type (e.g. *Ectocarpus*) and where the gametophytic and sporophytic phases are not identical such alternation of generation is called **heteromorphic** type (e.g. *Urospora*, *Cutleria*). In **haplobiontic** life cycle pattern the main plant body is gametophyte. The gametes produced from gametophyte undergo sexual union to form diploid zygote. The zygote gives rise to another distinct phase in the life cycle called carposporophyte. During development of carposporophyte meiosis of diploid zygote nucleus occurs. The carposporophyte bears carposporangia from which haploid carpospores are formed. The latter germinates to produce new haploid gametophyte (e.g. *Nemalion*) (**Word diagram 2.4**). Since there are two haploid

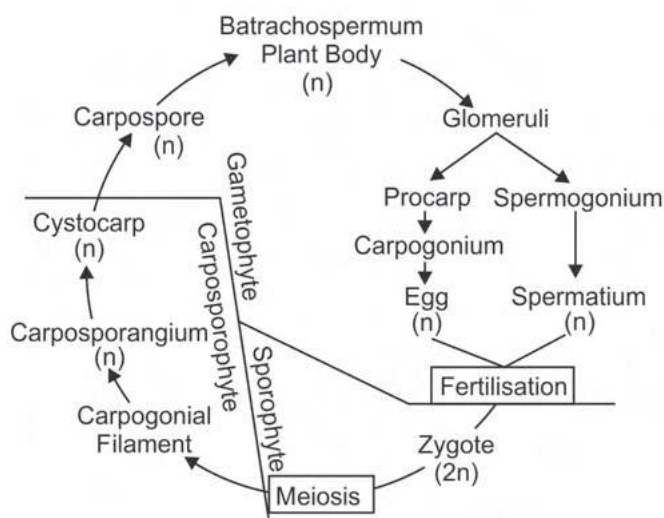

Word Diagram 2.4 : Triphasic life cycle : Haplobiontic type (*Batrachospermum*)

phases in the life cycle it may be called as haplohaplontic. The **diplobiontic** life cycle pattern is observed in the members of Rhodophyceae. Here the plant body is gametophyte that produces diploid zygote as a result of sexual reproduction. The zygote on germination develops into diploid carposporophyte. The latter bears carposporangia from which diploid carpospores are produced. The diploid carpospores germinate to give rise to another diploid phase called tetrasporophyte. The tetrasporophyte bears tetrasporangia which produce tetraspores by reduction division. The tetraspore on germination produces new gametophyte. Since three distinct phases exist in the life cycle this kind of

alternation of generation is known as triphasic alternation of generation. This kind of alternation of generation is also known as diplodiplohaplontic type because of the appearance of the two diploid and a haploid phase in a cyclic manner in the life cycle (e.g. *Polysiphonia*). (Word diagram 2.5)

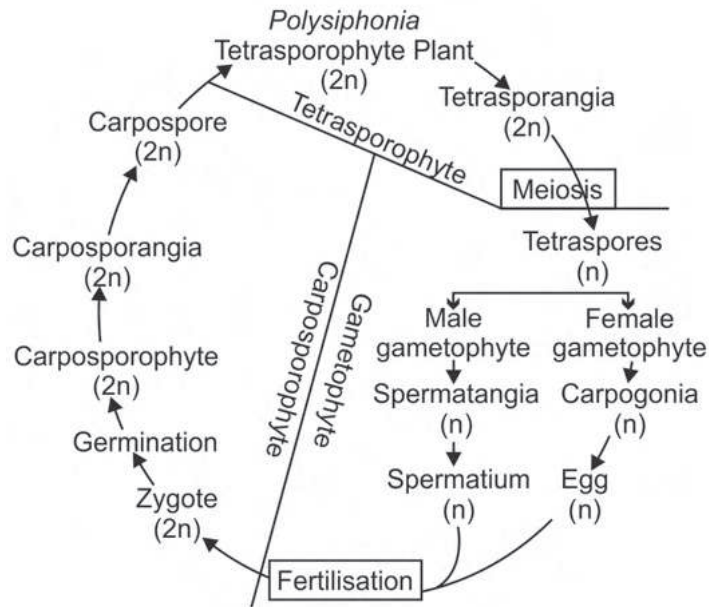

Word Diagram 2.5 : Triphasic life cycle : Diplobiontic type (*Polysiphonia*)

2.3 □ Range of thallus organization in algae

Algae have a wide range of thallus organization. It may be a simple unicell to a large complicated organisation. The different forms of thallus organization in algae are described below:

- a) **Unicellular motile forms:** The vegetative body is made up of a single cell with flagella. This simplest form of thallus organization is found in Bacillariophyceae, Chlorophyceae, Myxophyceae etc. *Chlamydomonas* of Chlorophyceae is a good example of unicellular form. Here the cell is characterized by having a cup shaped chloroplast with single distinct pyrenoid. The number and type of flagella attached to the unicell may vary greatly. In *Paraphysomonas vestita* the flagella is heterokontous and heterodynamous. Heterokontous flagella means, out of two flagella one is whiplash and the other is tinsel type. Heterodynamic flagella are those which have independent pattern of beat. (Figs. 2.6)

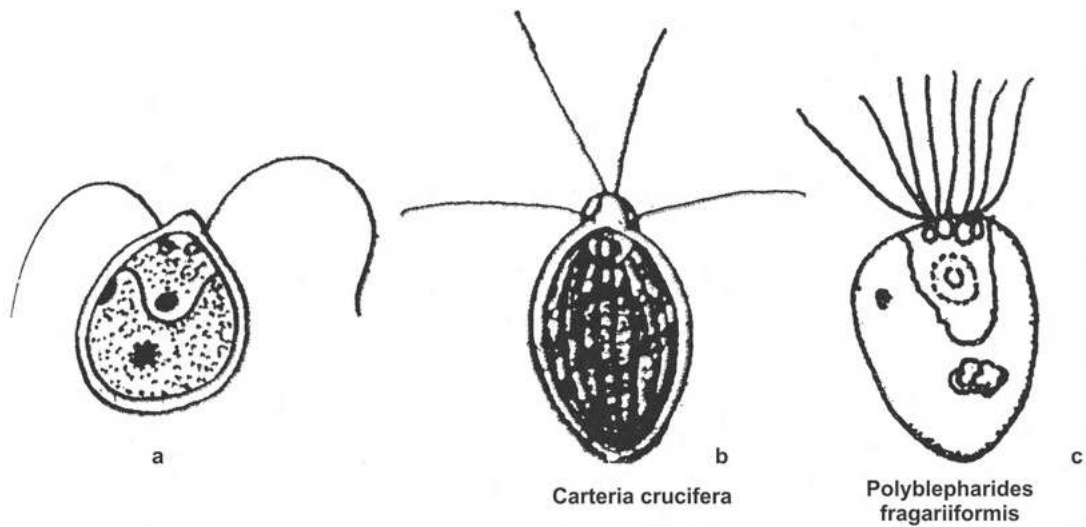

Fig. 2.6 : Unicellular motile thallus organization in different algae (a-c).

- b) Unicellular non motile form:** Here the plant body is unicellular and devoid of flagella. It is exemplified by *Chlorella* which is microscopic spherical with a single nucleus and cup shaped chloroplast. Fritsch (1935) called it as coccoid habit. This type of thallus organization is also found in the members of the class Chrysophyceae, Xanthophyceae, Rhodophyceae etc. (**Fig. 2.7**)

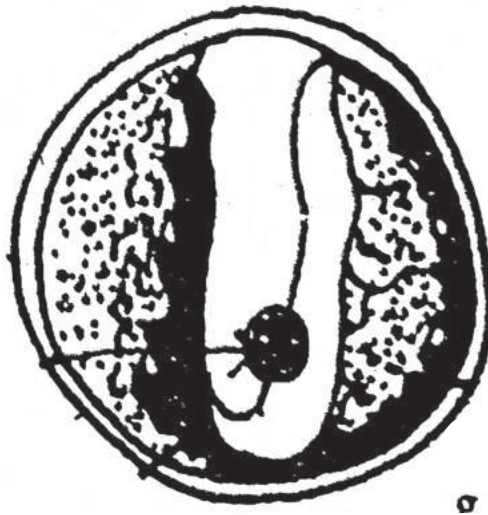
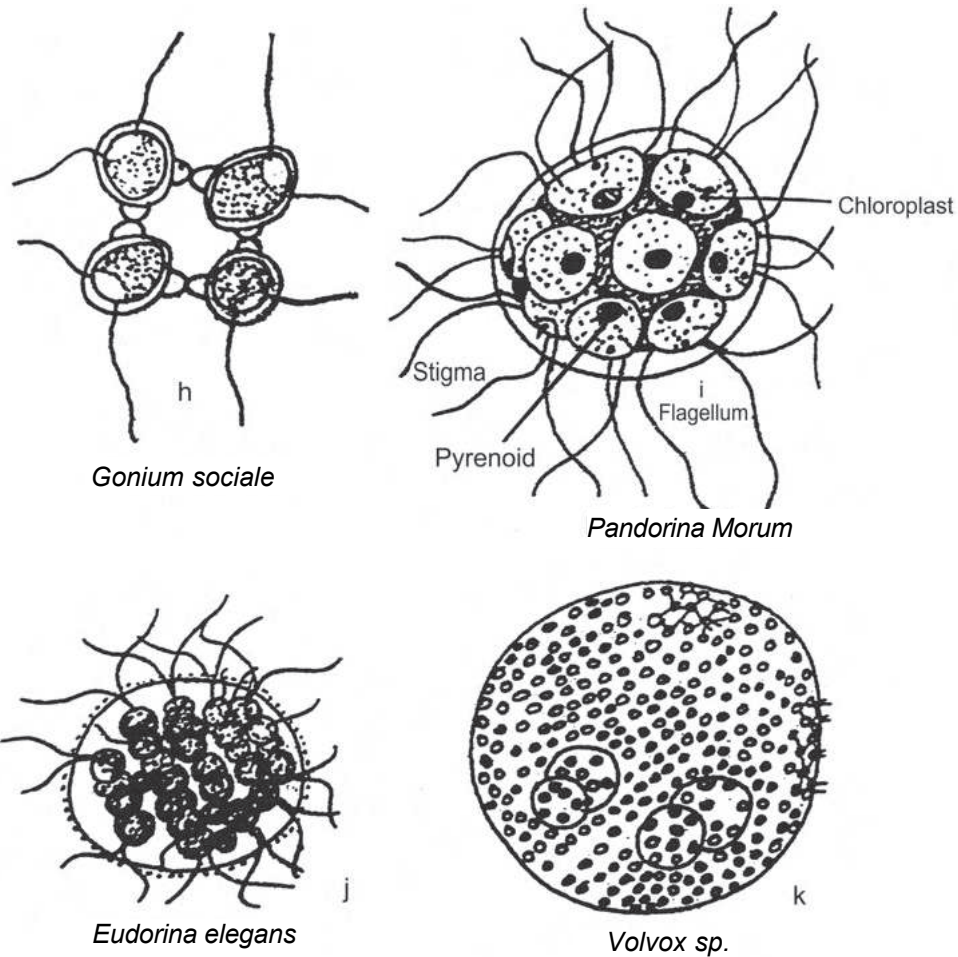

Fig. 2.7 : Unicellular nonmotile thallus of *chlorella*.

- c) Multicellular flagellated or colonial forms:** When many vegetative cells remain aggregated together within a common gelatinous matrix and remain interconnected

with each other by cytoplasmic strands, such thallus organization is called coenobium or colony. *Volvox* is a good example of colonial thallus organization. Here the colony has numerous peripheral flagella which impart motility. [Figs. 2.8]



Figs. 2.8 : Multicellular colonial forms of thallus organization in different algae (h-k).

- d) Multicellular non flagellated forms:** In this type the vegetative body of the algae forms a colonial organization and the colony lacks device for motility. The best example is *Hydrodictyon*. This type of thallus organization is predominantly found in Chlorophyceae (e.g. *Scenedesmus*, *Coelastrum*, *Pediastrum* etc.). [Figs. 2.9]
- e) Palmelloid forms:** In *Chlamydomonas*, *Chromulina* etc. the mother cell retracts flagella and divides repeatedly to produce 8, 16 or more cells. The

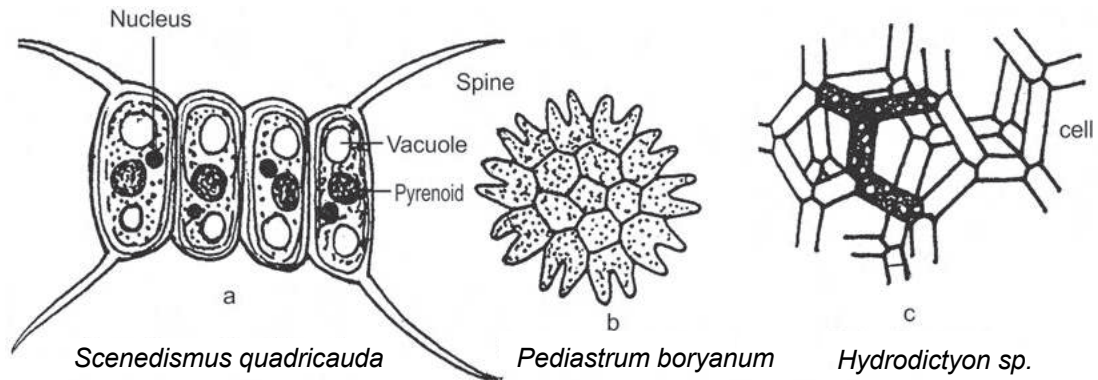

Figs. 2.9 : Multicellular non motile thallus organization in different algae (a-c).

daughter cells remain embedded in a common mucilaginous matrix in multiple groups, and the structure appears like the genus *Palmella*. Such stage is known as palmelloid stage. In palmelloid forms neither the number nor the shape and size of cells is constant. Palmelloid habit is the permanent features in *Phaeocystis*, *Chlorosaccus* etc. [Fig. 2.10]

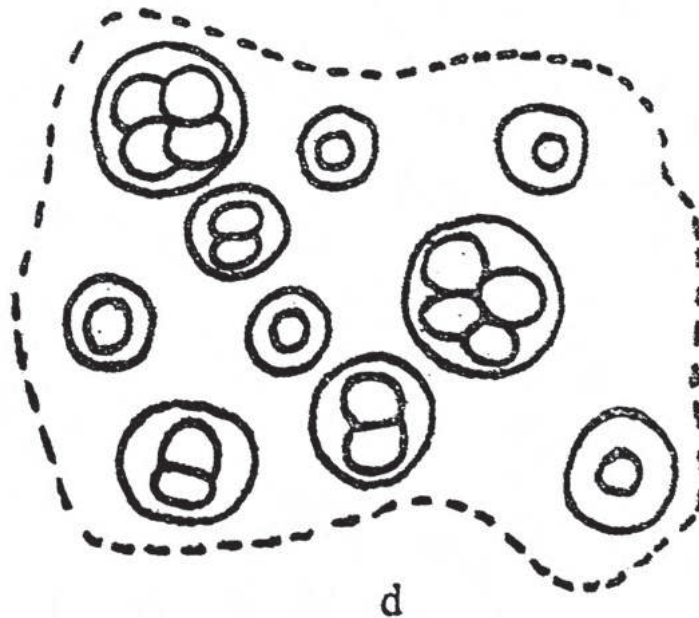

Figs. 2.10 : Palmelloid thallus of *Palmella* sp.

- f) **Dendroid forms:** In *Prasinocladus*, *Ecbalocystis* etc. this type of thallus organization is observed. The plant body appears like a microscopic tree. [Fig 2.11]

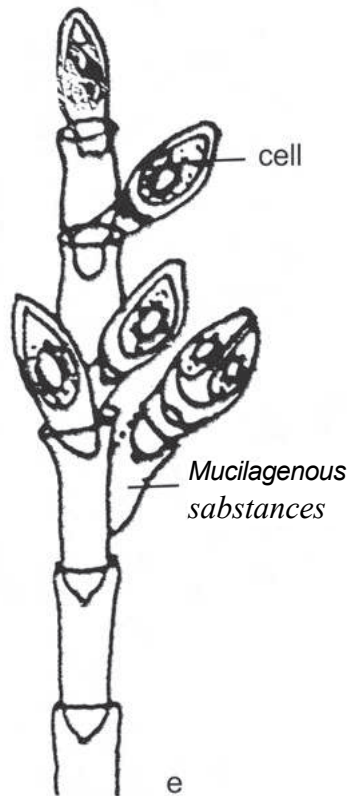

Fig. 2.11 : Thallus of *Prasinocladus marinus*



Fig. 2.12 : Thallus of *Cladophora*

- g) **Filamentous forms:** This is very common form of thallus organization. The vegetative cells are arranged in row to form a trichome. The trichome is covered by a mucilaginous sheath to produce the filament. Morphologically the filamentous thallus organization is of different types such as : i) **Unbranched filament** : The cells in this type of filament divides in a single plane, e.g. *Ulothrix*, *Oedogonium* etc. ii) **Branched filament** : When the cells of the individual filament divides in more than one plane it gives rise to a branched filamentous organization, e.g. *Cladophora*, *Pithophora* etc. [Fig. 2.12] iii) **Heterotrichous filament**: In this filamentous thallus organization, the plant body is differentiated into two systems such as prostrate or horizontal system and an aerial, erect or upright system. The

erect system is also called primary projecting system. It is the characteristic features of the order Chaetophorales of Chlorophyceae (e.g. *Draparnaldia*, *Stigeoclonium*, *Draparnaldiopsis* etc.). [Figs. 2.13]

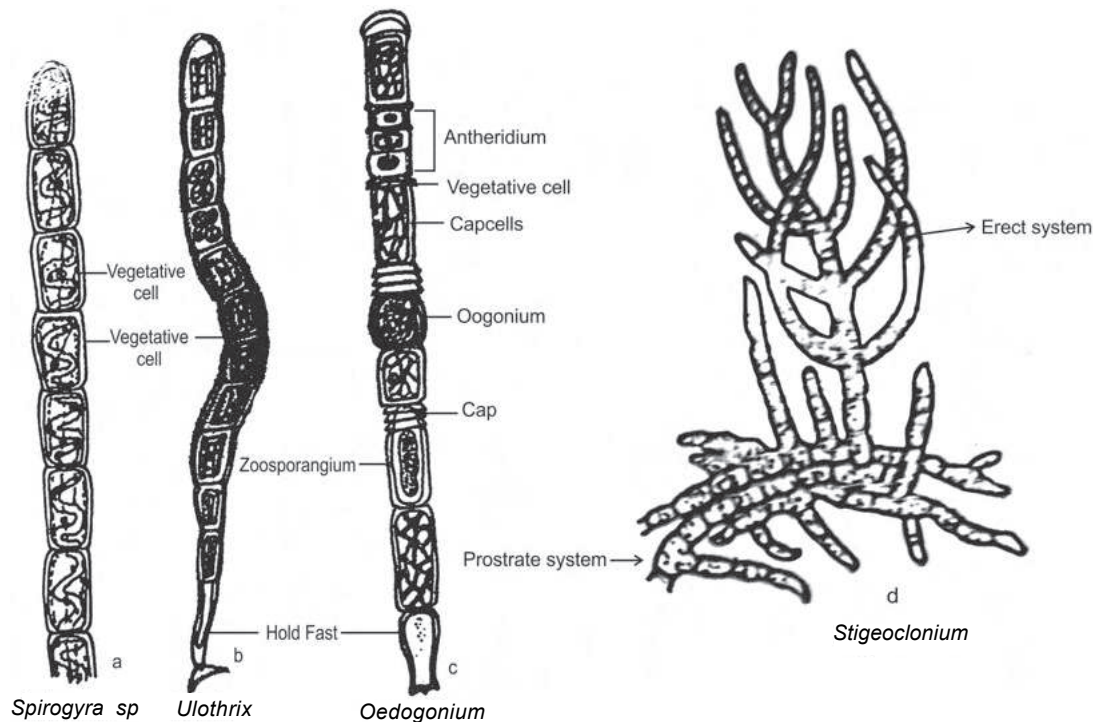

Figs. 2.13 : Unbranched filaments in different members of chlorophyceal (a-c). Heterotrichous thallus of *Stizeoclonium* (d).

h) Siphonous forms: This type of thallus organization characterized by the presence of a central siphon like vacuole. The thallus enlarges without any septum and because of having many nuclei it is called coenocytes (e.g. *Botrydium*, *Vaucheria*, *Valonia* etc.). [Fig. 2.14]

i) Uniaxial forms: It is a pseudoparnchymatous thallus organization in which the plant body has a central main axis from which

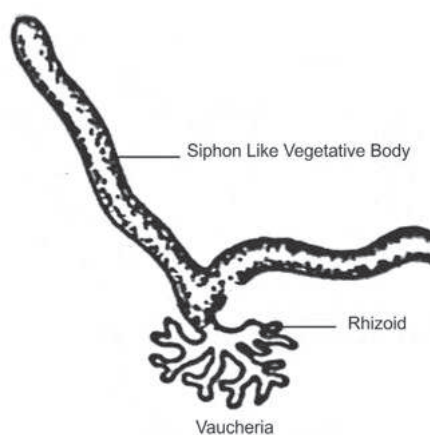
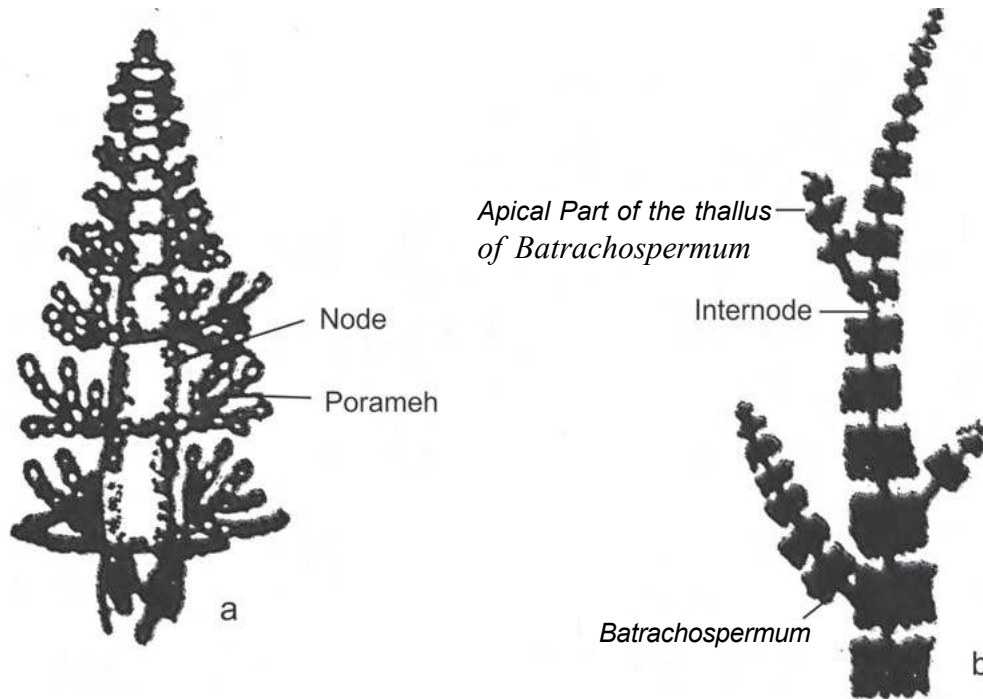

Fig. 2.14 : Morphology of the thallus of *Vaucheria*

other side branches are produced. According to Fritsch (1935), there is present a “close juxtaposition of the branch system of a single main axial thread” which forms the thallus (e.g. *Batrachospermum*). [Figs. 2.15]



Figs. 2.15 : Structural organization of the thallus of *Batrachospermum* (a, b)

- j) Multiaxial forms:** The thallus is made up of multiple threads which remain in close juxtaposition and giving the appearance of the thallus having more than one axes (e.g. *Polysiphonia*, *Nemalion*, *Scinia* etc.). [Fig. 2.16]
- k) Parenchymatous forms:** Here the division of the cells of the plant body takes place in numerous planes and gives rise to a thallus organization that looks like foliose , flat or sometimes tubular. It is found in the genera like *Ulva*, *Dictyota*, *Laminaria*, *Macrocystis* etc. [Fig. 2.17].

Conclusion: The different forms of thallus organization in algae represent how the evolution of thallus from a single unicellular form to multicellular parenchymatous forms has taken place. It is thought that unicellular motile form is the most primitive form which on retraction of flagella gives rise to non motile unicellular form. The latter is considered as ancestral form of different types of thallus organization and the evolutionary series ends in

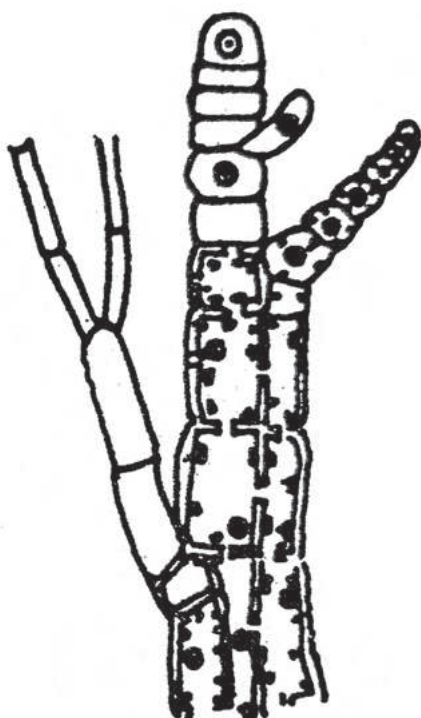

Fig. 2.16 : Morphology of thallus of *Polysiphonia*.

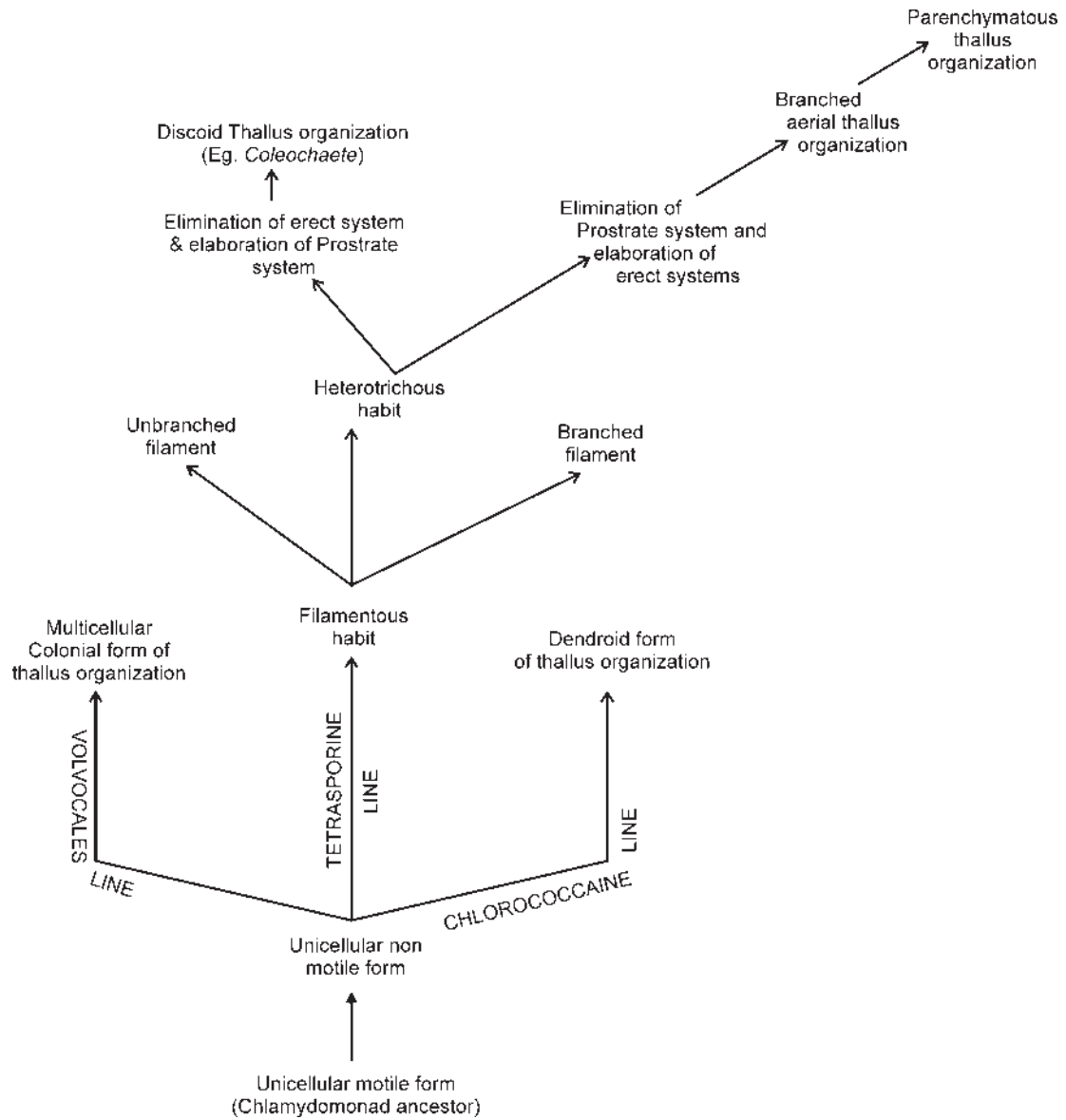

Fig. 2.17 : Morphology of thallus of *Ulva lactuca*.

the most evolved type. i.e. dendroid forms as per Chlorococcaine line of evolution. Among the filamentous habit simple unbranched filament is considered as most primitive from which branched and heterotrichous thallus organization has evolved. The heterotrichous habit gives rise to *Coleochaete* like discoid thallus organization through elimination of erect system and subsequent elaboration of prostrate system. The elimination of prostrate system and elaboration of erect system on the other hand lead to the origin of evolved form of thallus of algae like *Draparnaldia*, *Draparnaldiopsis* etc. The branched filamentous form is considered as the ancestral form of highly evolved parenchymatous thallus organization. The latter is evolved as a result of division of cells of the filament in irregular plane. (**Word diagram 2.6**)

2.4 □ Morphology and life cycle of *Nostoc*

Nostoc belongs to the Class Cyanophyceae (Blue Green Algae). It is a gelatinous aggregation of filaments commonly called 'star jelly'. It commonly grows in fresh water and



Word Diagram 2.6 : Evolutionary trends among different form of thallosal organization among algae.

forms ball like colonies of pin head size. Some species are terrestrial and grow in close association with mosses, liverworts. Some species occur as phycobiont such as *N. sphaericum*, *N. collema* etc. Their growth is also observed in moist hilly rocks. *Nostoc punctiforme* is an example of endophyte. It grows inside the thallus of *Anthoceros*. Some

common Indian species are *N.endophytum*, *N.rivulare*, *N.elliposporum*, *N. sphericum*, *N. muscorum*, *N. calcicola*.

Structure: The filament of *Nostoc* is multicellular, unbranched made up of many ovoidal or spherical cells. Each individual filament is made up of trichome covered by mucilaginous sheath. The cells are arranged in a beaded manner. The trichome is contorted or intertwined. The filaments are aggregated to form a ball like colony. The colonies are globular or ellipsoidal and reach a size of hen's egg in *N. pruniformae*. Inside the filament some barrel shaped, colourless, empty cells are present which are enlarged than normal vegetative cells. Such cells are nothing but modified vegetative cells responsible for fixation of atmospheric nitrogen and are called heterocyst. Heterocysts are usually intercalary in position but rarely terminal in *N. linckia*. [Figs. 2.18]

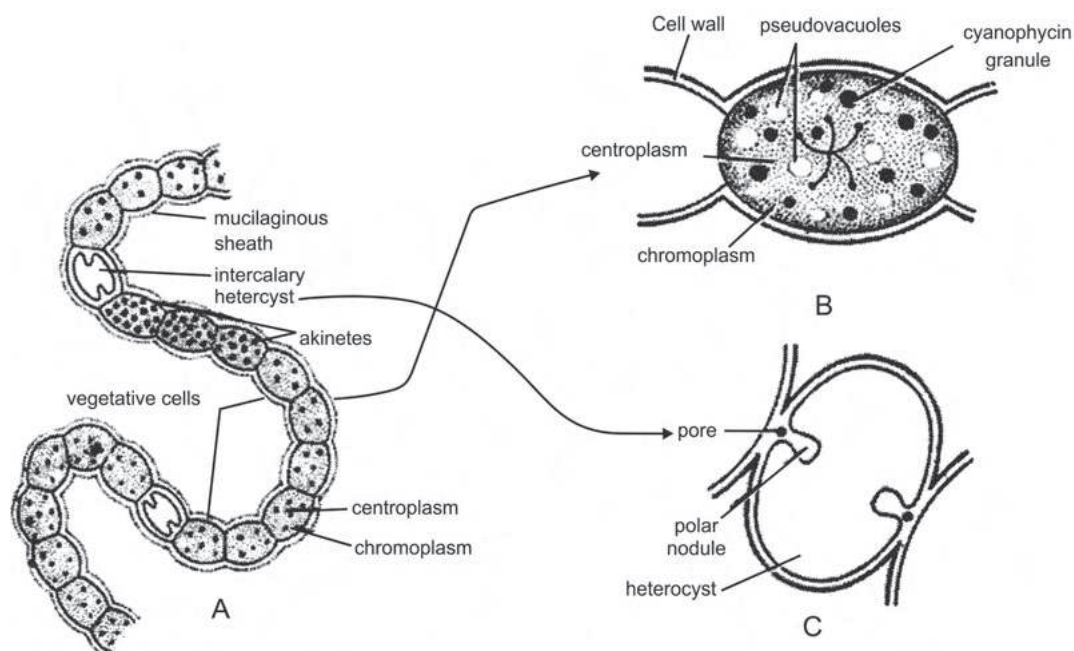

Figs. 2.18 : A, A single filament of *Nostoc*. B, A single vegetative cell; C, A heterocyst (enlarged view)

Internally, cells show prokaryotic cellular organization. The cytoplasm is differentiated into chromoplasm and centropiasm. Pigment constitution of a typical blue green algal cell (chlorophyll a, carotenoids, different types of xanthophylls, biliproteins like c-phycoyanin and c-phycoerythrin etc.) is present here. Pigments are not present in the chromatophore. Pigments are present on the membrane bound lamellar organization. The cell wall of the vegetative cell is mainly made up of murein. Proteinaceous cyanophycean granules and

cyanophycean starch is present in the cytoplasm as principal reserve material. The centropylasm is hyaline or colourless. The genetic material is present in this region in the form of incipient nucleus. [Fig. 2.19]

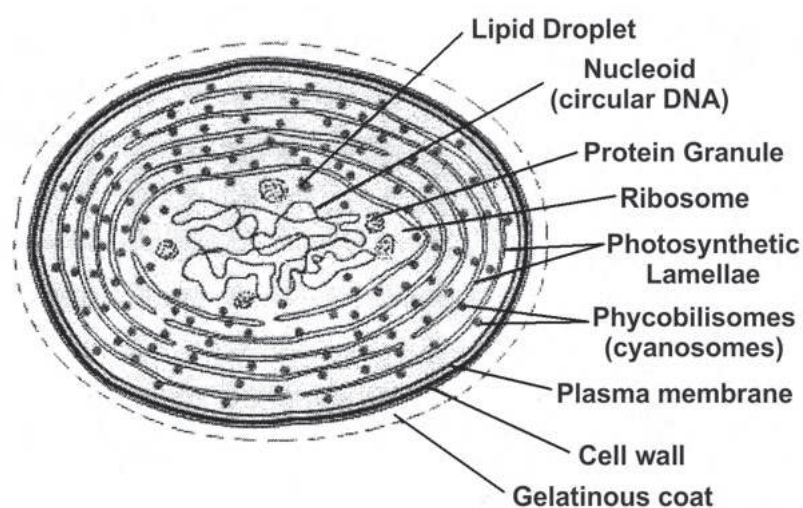

Fig. 2.19 : Internal structure of *Nostoc* cell.

2.4.1. Reproduction

Nostoc reproduces only by vegetative and asexual means. Sexual reproduction is entirely absent in it.

2.4.2. Vegetative reproduction

Vegetative reproduction in *Nostoc* takes place by fragmentation in which colony is broken into fragments and each individual fragment can grow into a new colony. Another method of vegetative reproduction is the formation of hormogonia. Within the colony individual filament is broken into pieces due to death of the cells in intercalary position. The broken trichomes pierce through the colony and serve as hormogones which develop their sheath and ultimately forms a new colony. Sometimes the hormogonia develop into fresh trichomes within the mother colony instead of coming out of it.

Asexual reproduction: Different types of resting bodies are formed for asexual reproduction in *Nostoc* which are as follows: a) **Akinetes** : These are thick walled resting bodies fo the filament produced as a result of modification of vegetative cells. The akinetes

being very thick walled can withstand extreme adverse condition. Akinates are filled with huge amount of cyanophycin granules along with reserve food materials. These are usually larger than vegetative cells and occur either singly or in the form of short chain inside the filament. In most of the species all the cells in between the heterocyst develop into akinates. Akinates germinate and give rise to new individual filament by liberating its content through the pore. **(Fig. 2.20) b) Heterocyst** : Rarely heterocyst in the filament may serve as reproductive organ. It germinates and gives rise to a new filament. At the time of germination the content of heterocyst divides into two cells and then into four celled structure which comes out through rupture of the cell wall and develops into a new filament. The heterocysts

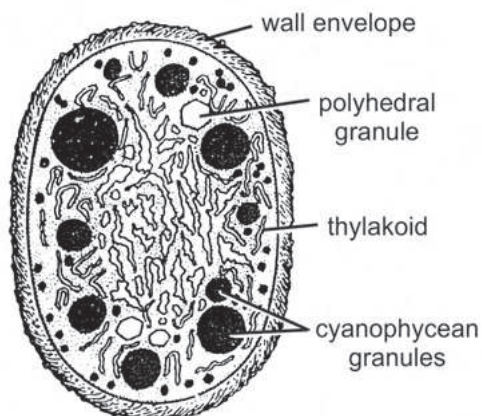

Fig. 2.20 : An akinete as viewed under electron microscope (diagrammatic)

are larger than vegetative cells. The cell wall is very thick and differentiated into outer sheath, middle cortex and inner investment. The cortex is hard and thick and made up of murein like bacterial cell. The cytoplasm is less granular. Glycolipid and acylipid is present in the heterocyst but absent in the vegetative cell. Lamellae though present in the heterocyst but lesser in number than normal vegetative cell. Normal PSII activity is absent in heterocyst and no photosynthetic oxygen evolution occurs. This adaptive feature protect nitrogenase enzyme of the heterocyst from toxic effect of oxygen, making the site suitable for nitrogen reduction. Besides, the thick wall of heterocyst prevents oxygen entry through it and protects the enzyme from oxygen damage. Thus heterocyst becomes the ideal site for nitrogen fixation. **(Fig. 2.21) c) Endospore** : In some species of *Nostoc*, spores of endogenous in origin are observed. Such spores like that of bacteria are called endospores. The latter germinate and give rise to new filament. Endospore formation is observed in species like *Nostoc microscopium*, *N. commune* etc.

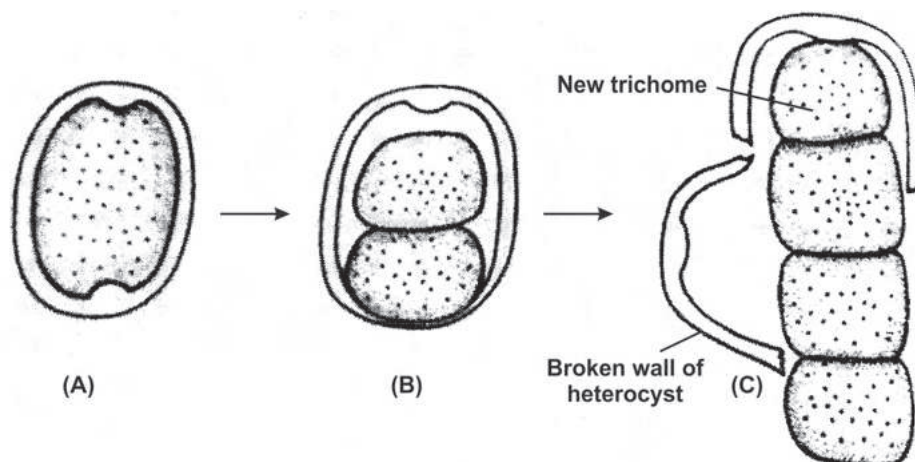

Fig. 2.21 : Development of daughter filament from heterocyst.

2.4.3 Systematic Position

According to Desikachary (1959)

Phylum : Cyanophyta

Class : Cyanophyceae

Order: Nostocales

Family : Nostocaceae

Genus: *Nostoc*.

2.5 □ Morphology and Life cycle of *Oedogonium*

Oedogonium belongs to the class green algae or Chlorophyceae. It is a fresh water filamentous alga found to grow in ponds, pools, lakes rivers etc.

2.5.1 Morphology of the filament

The filament of *Oedogonium* is long unbranched, multicellular, green remains attached to wide variety of substrata. There are three types of cells in the filament such as a) Basal colourless cell known as rhizoidal cell which is devoid of green pigments. The basal end of rhizoidal cell is specially modified to provide anchorage to the filament called hold fast. b) Green vegetative cells and c) Apical dome shaped cell. In between the rhizoidal and

apical cell the vegetative cells are arranged in row. Such intercalary cells are almost alike. At the junction between few cells in the filament ring like strictures are found to remain in stack. Such ring like structures are called apical cap. The number of apical cap at the junction between two vegetative cells denote how many times the vegetative cell has undergone division. During vegetative cell division the end of older cell is left as remnant which acts as apical cap.

2.5.2 Cell structure

The vegetative cells are rectangular in shape. The length of the cell is longer than breadth. Each cell is surrounded by a thick wall which is differentiated into three layers. The outer layer is made up of chitin, the middle layer is pectinaceous and the inner layer

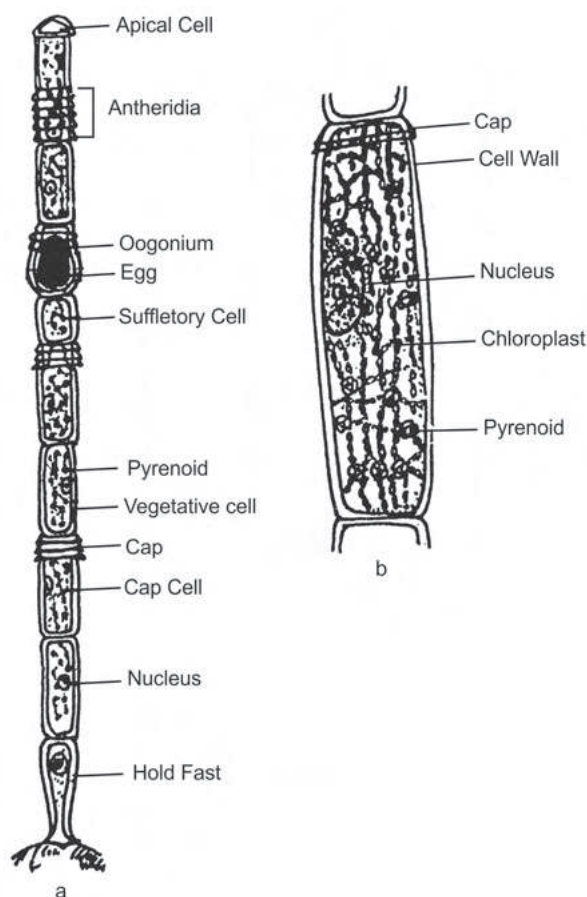

Figs. 2.22 : (a) Morphology of filament of *Oedogonium*., (b) Detail structure of the vegetative cell of *Oedogonium*.

is cellulosic. Just below the cell wall cytoplasmic membrane is present which encloses the cytoplasm. The cytoplasm is dense uninucleate. The nucleus is central in position, sometimes eccentric. The cytoplasm is characterised by having reticulate chloroplast with many pyrenoids. Mitochondria, golgibodies, endoplasmic reticulum and other cellular organelles are present. The cell usually contains a large central vacuole filled with cell sap. [Figs. 2.22].

2.5.3. Reproduction

Reproduction in *Oedogonium* takes place by vegetative, asexual and sexual means.

2.5.3.1 Vegetative reproduction takes place by fragmentation, akinete formation etc.

2.5.3.2 Asexual reproduction takes place by formation of zoospores. Under favourable condition the alga propagates by formation of huge number of zoospores. The zoospore formation generally initiates in the cap cell and the cap cell functions as zoosporangium. During differentiation of zoospore the protoplast of the zoosporangium contracts from the cell wall as a single unit. The entire protoplast assumes a round or oval shape. The nucleus moves towards one side of the protoplast. Just close to the nucleus a hyaline area differentiates. A crown of whiplash flagella develops around this region. When the zoospore is fully matured it ruptures the wall of the zoosporangium and released into the aquatic environment. After a period of motility the zoospores come to rest and germinate to give rise to new filament. The zoospores are pear shaped, green, uninucleate with a beak like colourless anterior end. [Figs. 2.23]

2.5.3.3 Sexual reproduction : The sexual reproduction in *Oedogonium* is typically oogamous. Two types of morphologically distinguishable sex organs are produced to accomplish the process. The male sex organ is called antheridium and the female sex organ is called oogonium. Based on the location of male sex organ that is antheridia, the species of *Oedogonium* has been classified into two categories such as a) Macrandrous species and b) Nannandrous species.

A)Macrandrous species: In these species the vegetative cells of the filament is developed into antheridium. Vegetative and asexual reproduction in these species takes place following the process as discussed earlier. Whether the male sex organ or antheridia

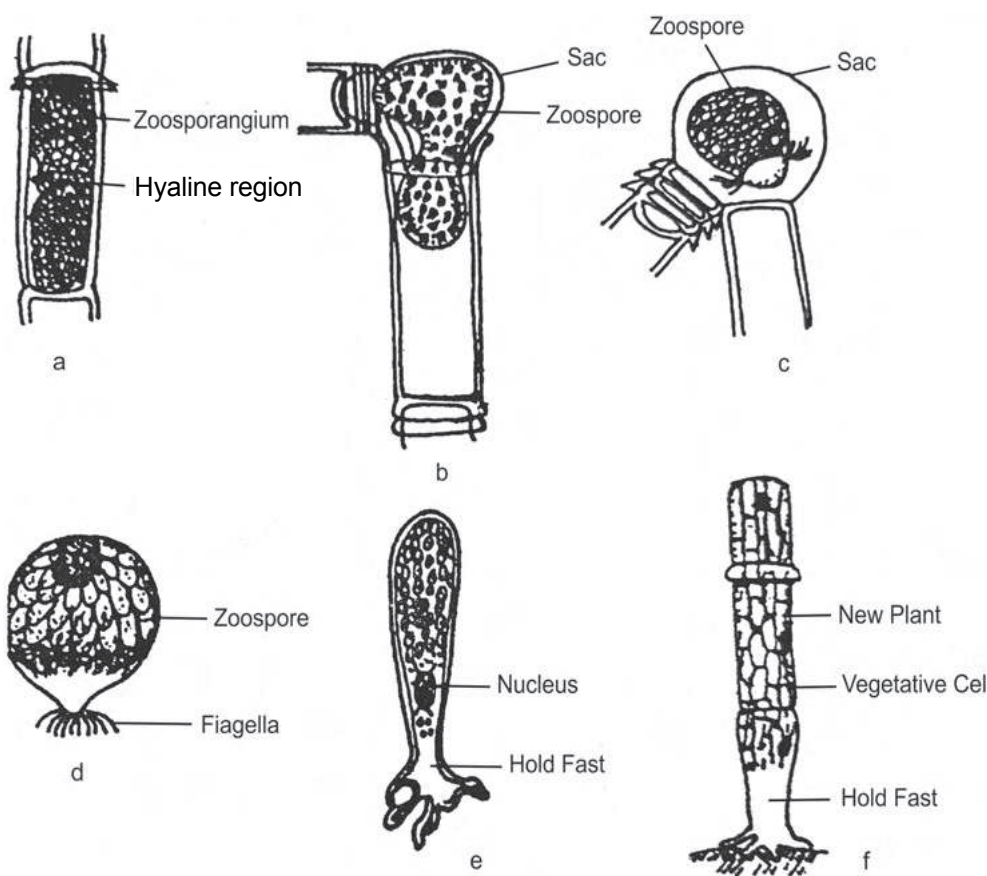

Figs. 2.23 : Development and release of zoospore from zoosporangium (a-c) in *Oedogonium*. Germination of Zoospore to give rise to new plant body (d - f) in *Oedogonium*.

and female sex organ oogonia are produced in the same or different filament the macrandrous species are of two types such as **Macrandrous monoecious** (e.g. *O. fragile*, *O. nodulosum* etc.) and **Macrandrous dioecious** (*O. crassum*, *O. aquaticum*).

In **macrandrous monoecious** species the male and female sex organs are produced in the same filament i.e. these species are homothallic. Any vegetative cell of the filament may serve as antheridial initial. It divides transversely in a repeated manner to form row of flat cells. The nucleus of each cell divides mitotically into two daughter nuclei. Each nucleus is metamorphosed into an antherozoid. Thus two antherozoids are produced from each antheridium. Antherozoids are multiflagellated structure, morphologically similar to zoospore except their size. The size of antherozoids is smaller than zoospores. Antherozoids are liberated by rupturing the wall of antheridium. The oogonia are produced in the antherida

bearing filament. A cap cell of the filament serves as oogonium mother cell. It divides transversely into two daughter cells. The lower one remains undivided and functions as supporting cell or suffultory cell. The upper cell is modified to form oogonium proper. The supporting cell has less cellular content and it usually remains undivided. In some species however this cell serves as another oogonial initial. In *O. americanum* the suffultory cell is absent. Each oogonium is round, thick walled structure having a single prominent egg nucleus inside. The content of the oogonium is filled with reserve materials. At the anterior end of the oogonium wall a slit or pore develops, below which a clear or hyaline cytoplasmic area becomes visible inside the egg. Such area is known as **receptive spot**. This site is considered as the attachment site of the antherozoid. **(Word diagram 2.7) & (Fig. 2.24)**

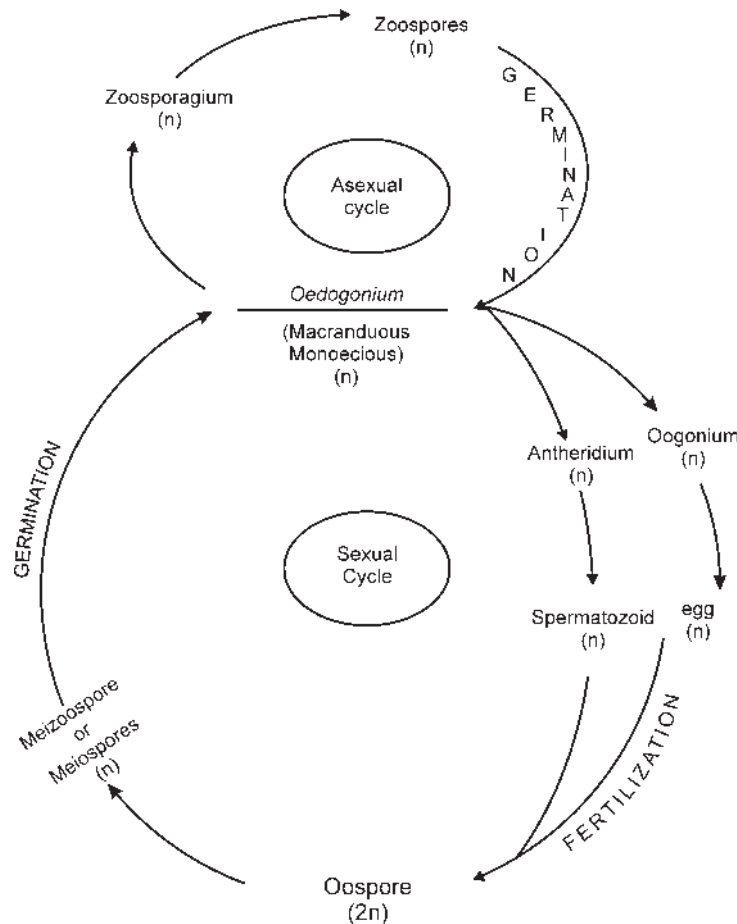

Word Diagram 2.7 : Life cycle of Macrandrous (Monoecious) species of *Oedogonium*.

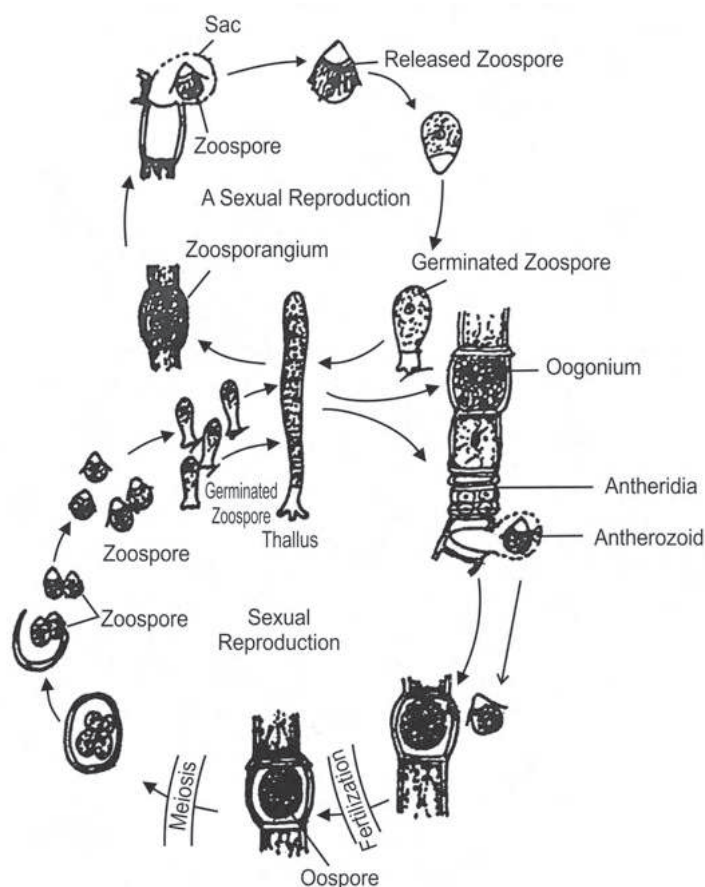

Fig. 2.24 ; Life cycle of macrandrous monoecious species of *Oedogonium*.

In **Macrandrous dioecious** species the antheridia and oogonia are produced in two different filaments. So, dioecious species are heterothallic. The development of antheridia and oogonia are similar as discussed above (**word diagram 2.8**) & **Fig. 2.25**.

Antherozoids being released from antheridia reach the pore or slit of the oogonium by swimming. It enters through the pore or slit and penetrates the egg through hyaline receptive spot. The oospore is then developed following plasmogamy and karyogamy.

B) Nannandrous species: The nannandrous species of *Oedogonium* are heterothallic that is antheridia and oogonia are never developed on the same filament. Here the development of antheridium takes place on a peculiar short or dwarf filament called nannandrium or dwarf male filament. The latter is produced as a result of germination of a special kind of spore called androspore which is differentiated within a sporangium called androsporangium. Whether the androsporangia are formed inside the normal oogonia bearing

filament or inside a specialized androsporangiate filament, the nannandrous species are of two types such as **Gynandrosporous nannandrous** (e.g. *O.concatenatum*) and **Idioandrosporous nannandrous** (e.g. *O.confertum* and *O.iyengarii*) species.

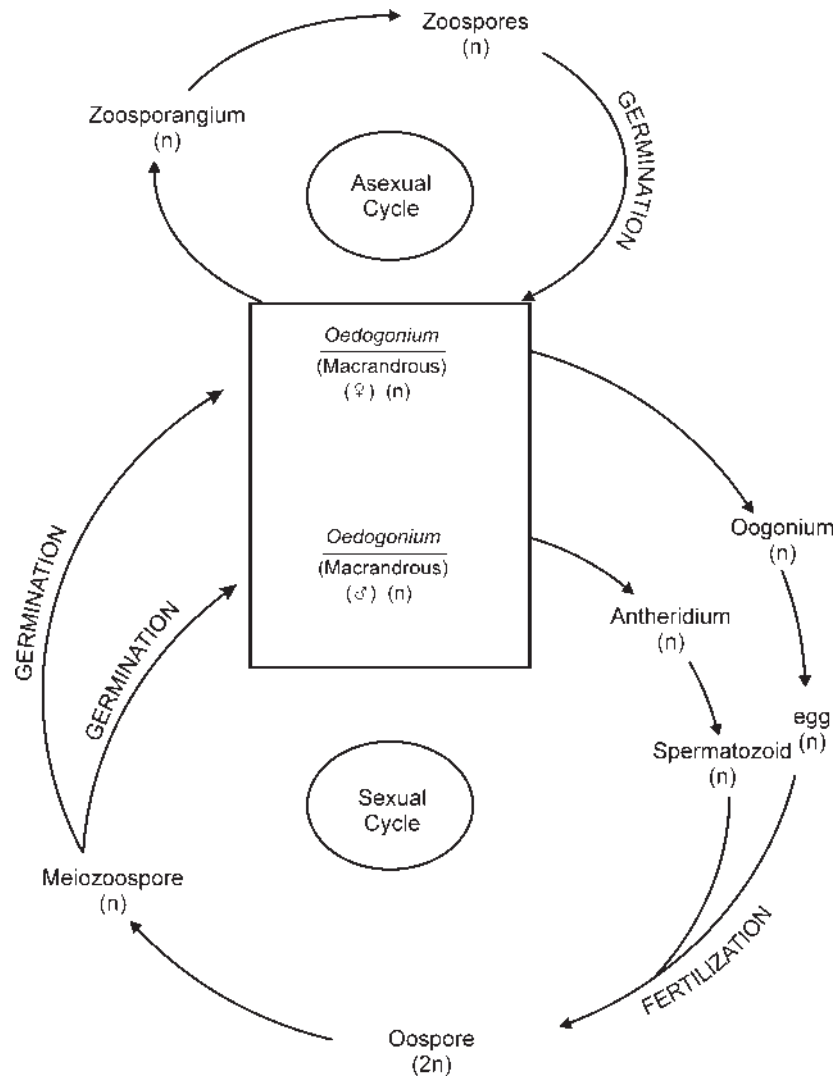

Word Diagram 2.8 : Life cycle of Macrandrous dioecious species of *Oedogonium*.

In **Gynandrosporous nannandrous** species the oogonia bearing filament forms androsporangia. The development of androsporangia is similar to that of antheridia. The vegetative cell divides transversely and form row of disc like cells. The protoplast of each disc like cell is metamorphosed into a small muliflagellated spore called androspore. The

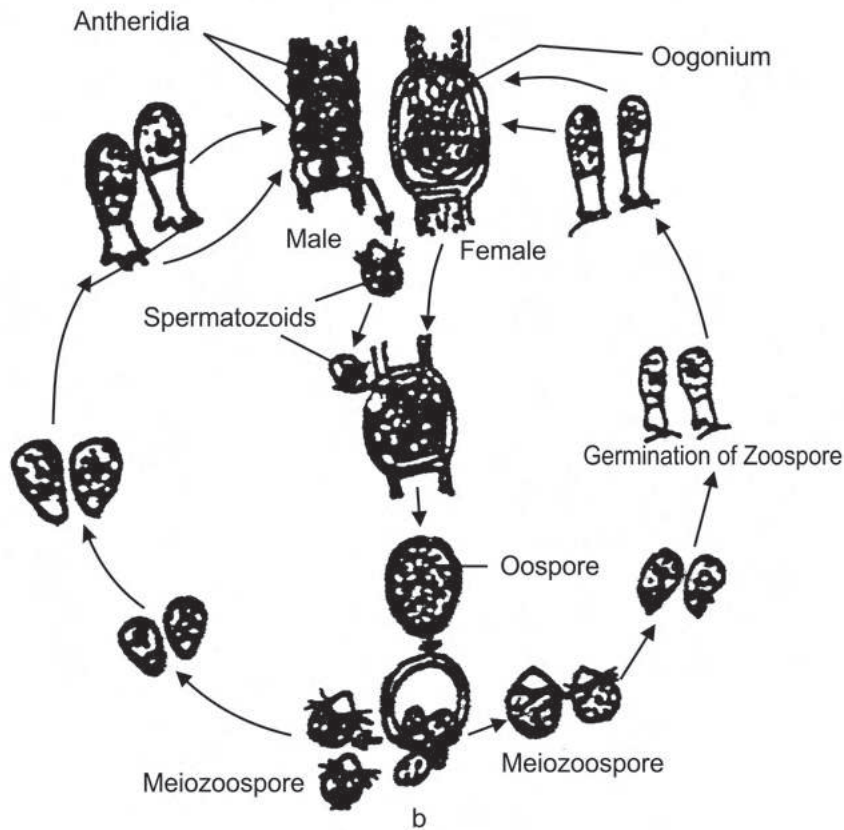
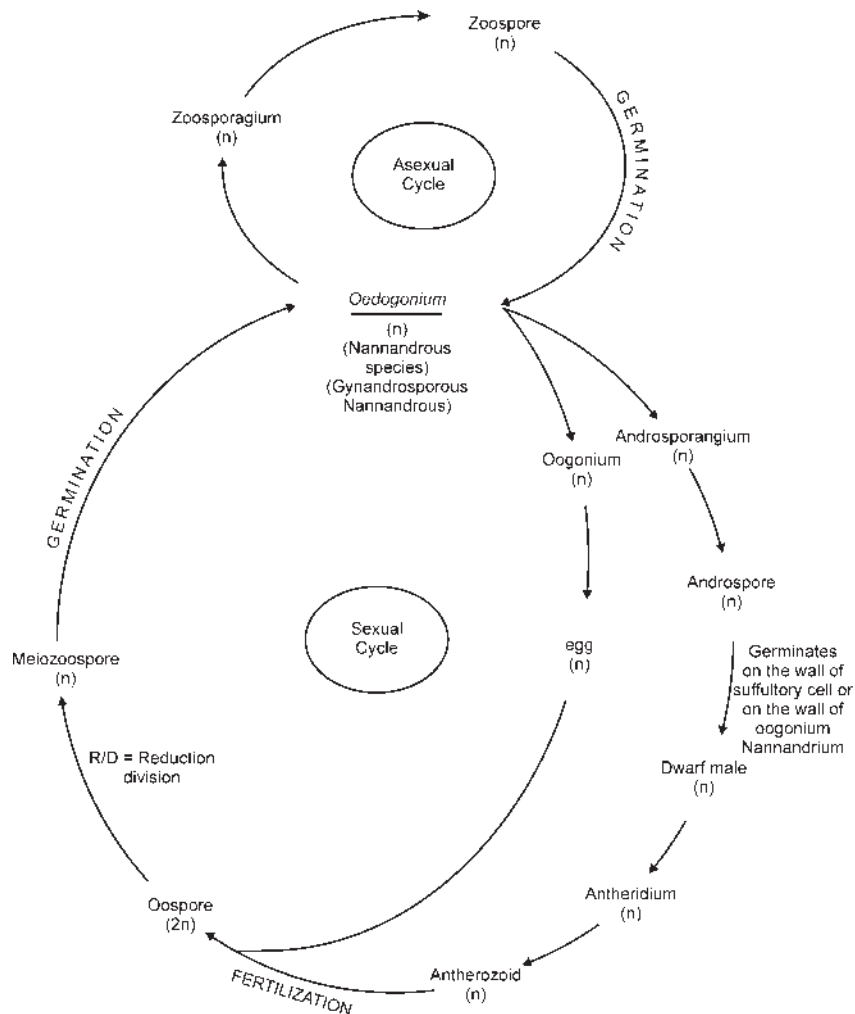

Fig. 2.25 : Life cycle of macrandrous dioecious species of *Oedogonium*.

size of androspore is smaller than zoospore but larger than gamete. The single uninucleate androspore is released from androsporangium by rupturing its wall. After liberation it begins to swim and ultimately binds on the wall of the oogonium or on the wall of the suffultory cell where it germinates and produces a few celled dwarf male filament or nannandrium. The terminal cell of the nannandrium serves as antheridium. The antheridium is larger than other cells of nannandrium. The nucleus of antheridium is metamorphosed into single multiflagellated antherozoid or spermatozoid. It is released from the antheridium by rupturing its wall and fertilizes the egg present inside the oogonium of the same filament to produce oospore. (**Word diagram 2.9**).

In **Idioandrosporous species** a separate filament bearing androsporangia is required to accomplish the process of sexual reproduction. The androsporangiate filament bears a row of androsporangia. The wall of androsporangium ruptures and androspore is released



Word Diagram 2.9 : Life cycle of Gynandrosporous nannandrous species of *Oedogonium*.

which reaches to the wall of supporting or suffultory cell or to the wall of oogonium of the oogonium bearing filament where it germinates to produce dwarf male or nannandrium. So in idioandrosporous species the oogonia bearing filament will never produce androsporangia and it has to depend upon a separate androsporangiate filament to accomplish sexual reproduction. In a similar manner as discussed in gynandrosporous species the antheridium produced on the nannandrium releases antherozoid which fertilizes the egg of the oogonium present in the oogonia bearing filament to form diploid oospore. **(Word diagram 2.10).**

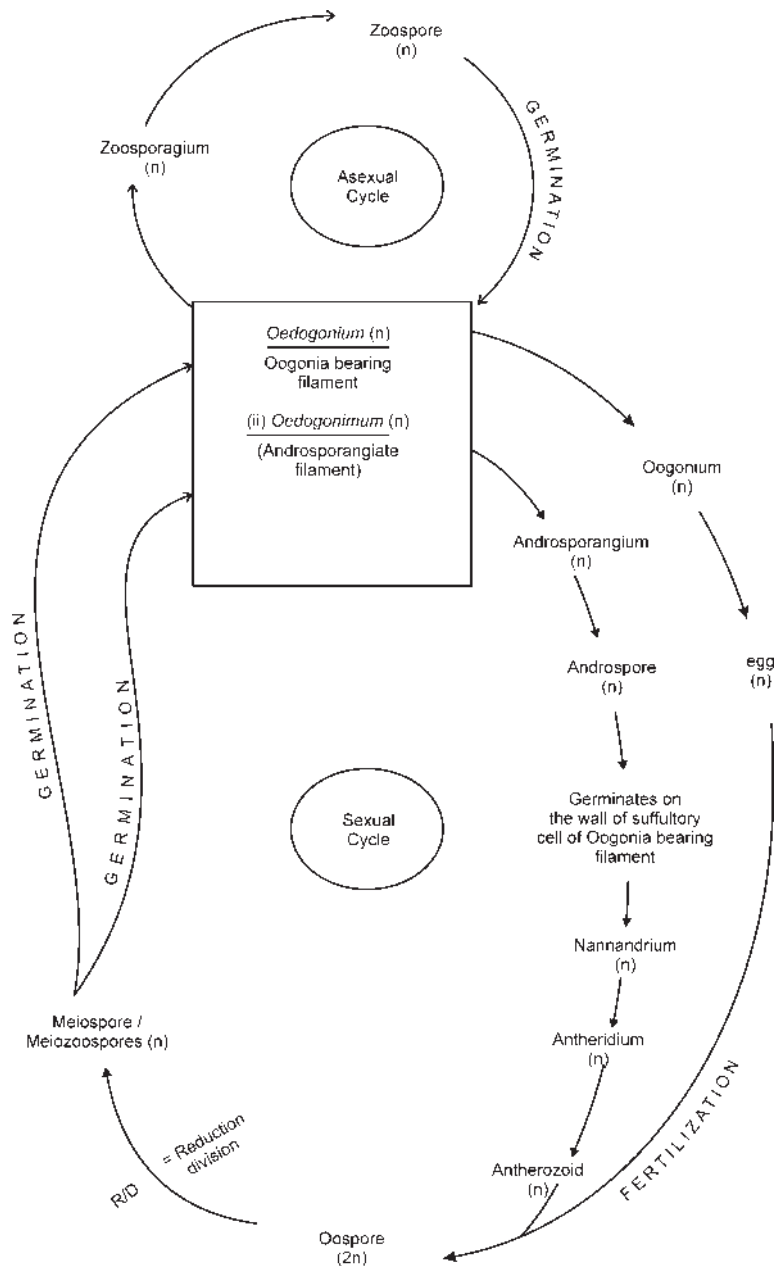

Word Diagram 2.10 : Life cycle of Idioandrosopus nannandrous species of *Oedogonium*.

Irrespective of the nature of the species, the oospore overcomes a resting period and then germinates. During germination, the diploid nucleus of the oospore undergoes reduction division and forms four haploid nuclei. Each of the haploid nucleus is

metamorphosed into multiflagellated motile spore called meiozoospore or gonozoospore. The latter, after a brief period of swimming comes to rest and retracts its flagella and then by repeated divisions forms a new filament. Thus germination of a single oospore gives rise to four daughter filaments. In macrandrous dioecious species out of four meiozoospores two give rise to male filament and remaining two give rises to female filament. In idioandrosporous species however two meiozoospores produce two androsporangiate filaments whereas remaining two produce oogonia bearing filaments. (Fig 2.26 & 2.27)

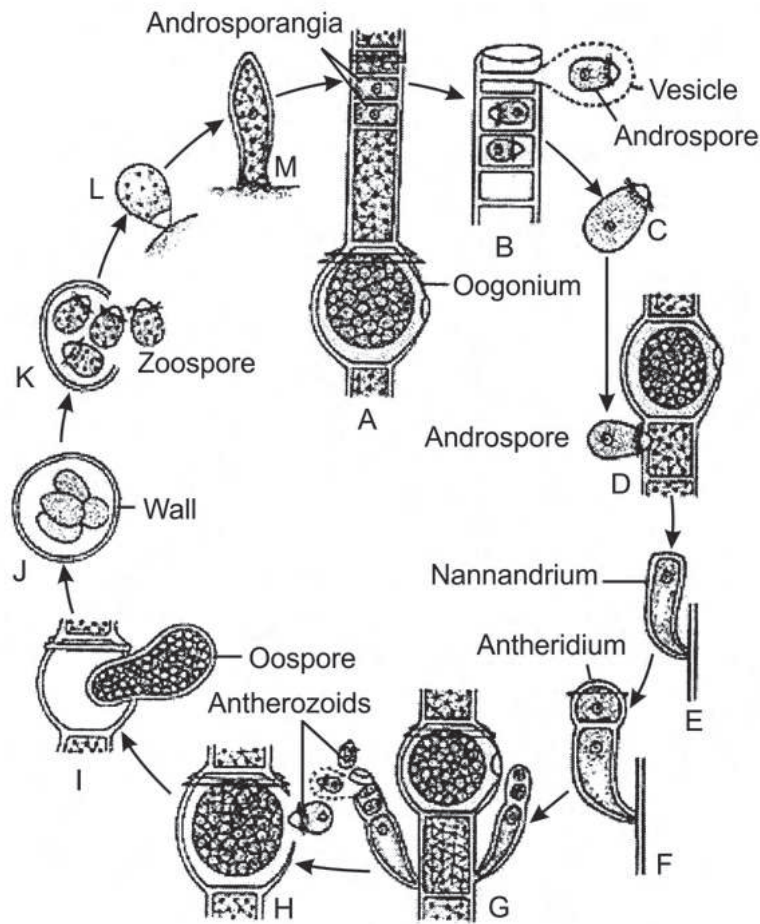

Fig. 2.26 : *Oedogonium*. Diagrammatic life cycle in gynandrosporous, nannandrous species of *Oedogonium*.

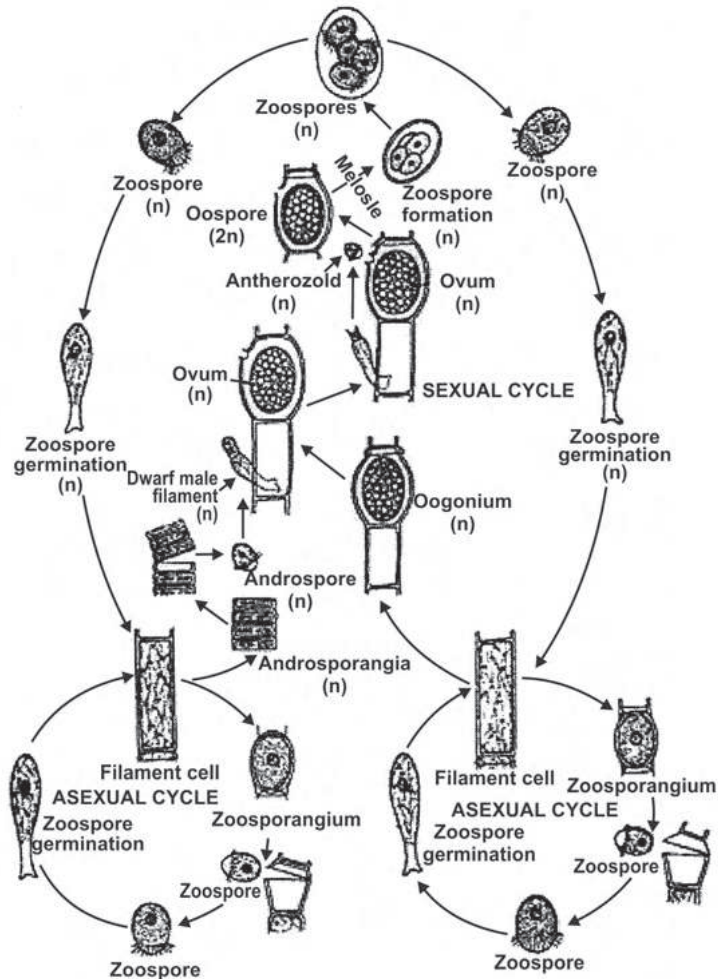

Fig. 2.27 : Life cycle of nannandrous (all are dioecious) – idioandrosporus species of *Oedogonium*.

2.6 □ Systematic Position

According to Bold and Wynne (1978)

Division: Chlorophycophyta

Class: Chlorophyceae

Order: Oedogoniales

Family Oedogoniaceae

Genus: *Oedogonium*

2.7 □ Morphology and life cycle of *Polysiphonia*

Polysiphonia is a red alga belonging to the class Rhodophyceae. The genus is represented by about 150 species. The species are exclusively marine and cosmopolitan in distribution. Some species are also epiphytic. *P. ferrulacea* and *P. urceolata* grows epiphytically on the thalli of *Laminaria*. *P. fastigiata* is a semiparasite that grows on *Ascophyllum nodosum*. [Figs. 2.28]

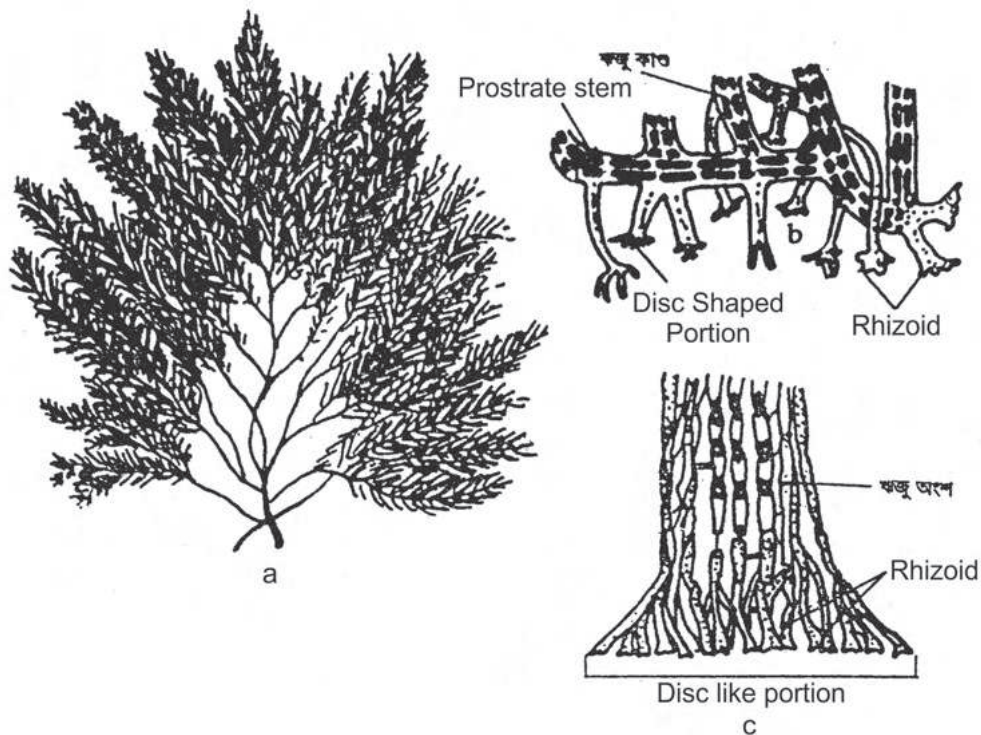

Figs. 2.28 : Morphology of the filament of *Polysiphonia*. (a) Polysiphonous organization of the erect system (b) Details of the prostrate system (c) Disc shaped basal region of the erect system of filament.

2.7.1. Structure of thallus

The vegetative body of the thallus is bushy in appearance, reddish or bluish red or dark brown in colour. The branches are feathery in appearance. Thallus is composed of siphon like cells arranged in definite tier which provides polysiphonous organization and for which the genus is so named. There are two systems in the thallus such a prostrate system and erect system. The attachment system made up of polysiphonous creeping structure with

unicellular rhizoids is found in *Purcellata*. The rhizoids form distinct lobe at its tip. Attachment disc with multiple rhizoids is found in the species like *P. violacea*, *P. elongata* etc. The erect system arises from prostrate system. It consists of a central main axis from which branches arise. The branches are of two types. The branches of unlimited growth are polysiphonous and it similar in appearance as that of main axis. Two types of cells are found in these branches such as central cells which constitute central siphon and pericentral cells which constitute pericentral siphon. The pericentral cells usually remain undivided but in some species those can divide and by addition of cells form cortical siphon. The branches of limited growth are unisiphonous and are called as trichoblast. The trichoblasts are colourless, spirally arranged, sex organ bearing branches. [Figs. 2.29]

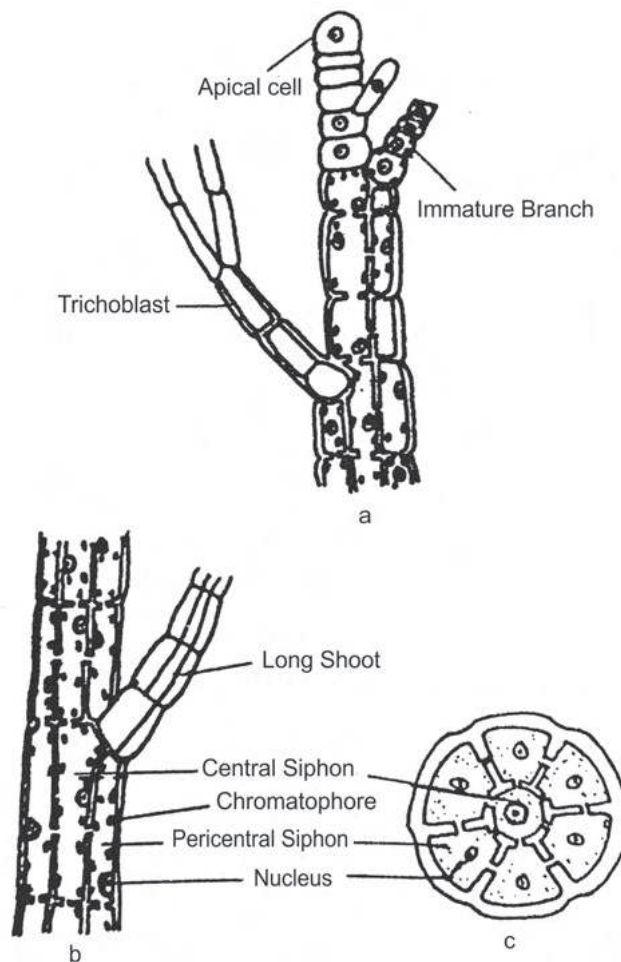

Figs. 2.29 : Structural details of the filament of *Polysiphonia*, (a) Apical part of the filament (b) Cellular organization of the axis of filament. (c) T. S. through the filament.

2.7.2. Reproduction

Typical oogamous type of sexual reproduction is found in *Polysiphonia*. There are three distinct stages in the sexual cycle such as gametophyte, carposporophyte and tetrasporophyte.

2.7.2.1 Gametophyte

Polysiphonia is dioecious and heterothallic. Therefore, two types of gametophyte are required to complete the sexual process such as male and female gametophyte.

2.7.2.2 Male gametophyte

The male gametophyte bears male trichoblast from which male sex organ i.e. spermatangia are produced in cluster. The spermatangial cluster produce a cone shaped appearance. During the development of spermatangia, the cells of unisiphonous fertile male trichoblast begin to divide except few basal cells and add pericentral cells. The pericentral cells gradually differentiate into spherical or rounded structure called spermatangium. The uninucleate protoplast of the spermatangium produces a single male cell called spermatium which is liberated through the narrow apical slit in the elastic spermatangial wall. Being non motile the spermatia are translocated by the sea water to the female sex organ. [Figs. 2.30].

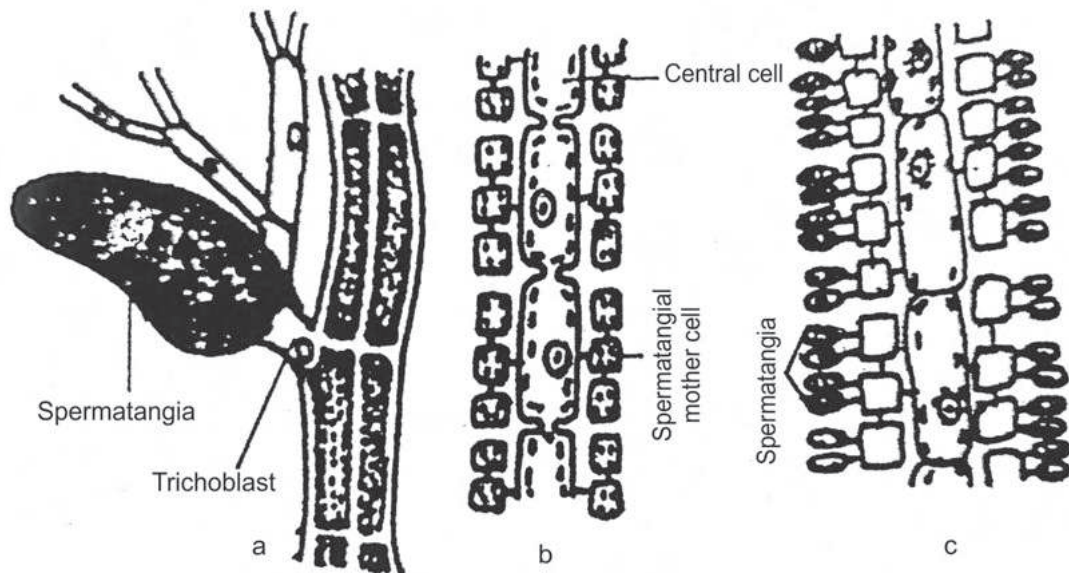

Figs. 2.30 : Developmental stages of male gametophyte of *Polysiphonia*.

2.7.2.3 Female gametophyte

The female gametophyte bears female reproductive structure called carpogonium. The latter develops from a branch called female trichoblast. The female trichoblast is initially unisiphonous but later on it becomes polysiphonous by division of central cells. One of the adaxial pericentral cell of the female trichoblast serves as supporting cell which divides and redivides to form a short filament of 5-7 cells in length. It is called carpogonial filament or procarp. The terminal cell of the carpogonial filament develops into a flask shaped structure called carpogonium. The neck of the carpogonium is elongated and it is called trichogyne. Its swollen base bears a single female nucleus. The supporting cell meanwhile produces two daughter cells by division, one to its base and another at its lateral position. The basal cell serves as basal sterile filament initial and the lateral cell serves as lateral sterile filament initial. Two to three celled basal and lateral sterile filaments is derived from such initials respectively. The pericentral cells adjacent to the supporting cell grow out into outgrowths which after fertilization develop into an envelope or sheath around the fruit body. The sheath is known as **pericarp**. [Pic 26]

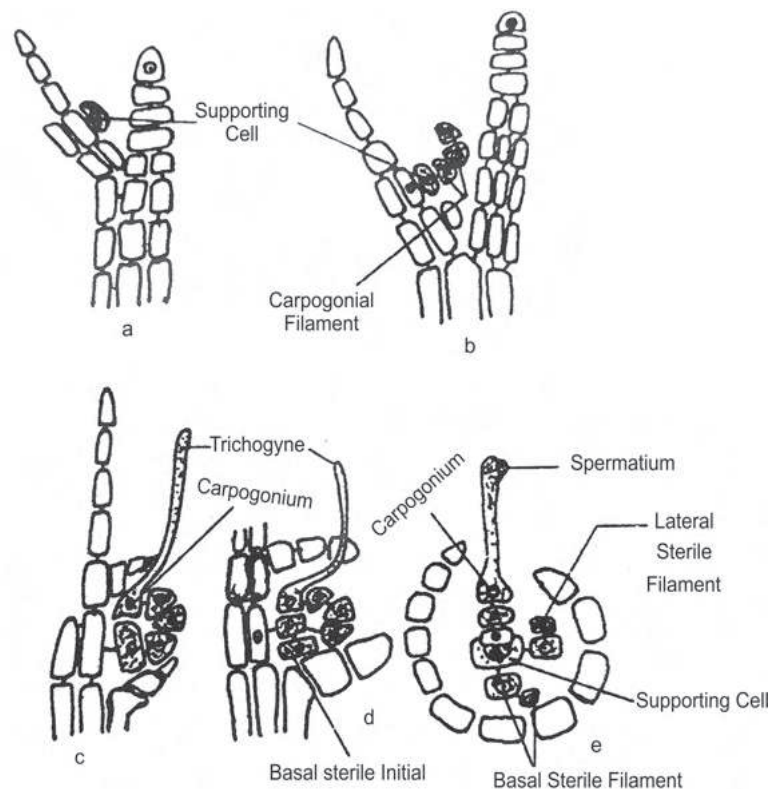

Figs. 2.31 : Developmental of female gametophyte of *Polysiphonia*.

2.7.2.4 Fertilization

The spermatium is carried passively by water current to the trichogyne of the carpogonium. The contact wall inbetween them dissolves and the male nucleus of the spermatium passes through the trichogyne to reach the basal swollen end of the carpogonium where it lies by the side of female nucleus. After fusion of the two nuclei a diploid nucleus is produced.

2.7.2.5 Post fertilization changes

After fertilization profound changes take place that lead to the development of carposporophyte. The changes are as follows:

- i) The supporting cell after fertilization develops a cell towards its upper end which is called auxiliary cell. The auxiliary cell contains a haploid nucleus.
- ii) Soon after the development of auxiliary cell a tubular connection is established between the base of the carpogonium and the auxiliary cell. The diploid nucleus present in the carpogonium divides mitotically into two daughter nuclei. One of the nuclei migrates into the carpogonium through the tubular connection.
- iii) Now the auxiliary cell has two nuclei. One is its own haploid nucleus and the other is the migrated diploid nucleus from the carpogonium. Soon the haploid nucleus of the auxiliary cell disintegrates and the migrated diploid nucleus divides mitotically into two daughter nuclei. Out of the two daughter nuclei produced one remain inside the auxiliary cell and the other migrates into the lateral outgrowth developed from auxiliary cell. Such outgrowth with migrated diploid nucleus ultimately forms an initial called gonimoblast initial.
- iv) By repeated division gonimoblast initial forms multiple initials which later differentiate into many compactly arranged gonimoblast filaments. The cells of the gonimoblast filament are diploid. The end or terminal cell of such filament develops into pear shaped carposporangium. The nucleus of the carposporangium is metamorphosed into diploid carpospores.
- v) With the differentiation of gonimoblast filaments, the auxiliary cells, supporting cells and the cells of basal and lateral sterile filaments are fused with each

other and form the placental element. This fused and disintegrating mass provides nutrition to the growing carposporophyte.

- vi) Meanwhile the pericentral cells adjacent to the supporting cell grow surrounding the developing mass of gonimoblast filaments. Such growth transform into an urn shaped covering with a terminal opening called ostiole. The covering has two layers and is known as pericarp. So the entire structure with placental element, gonimoblast filaments with carposporangia and pericarp is known as cystocarp. **(Figs. 2.32)**

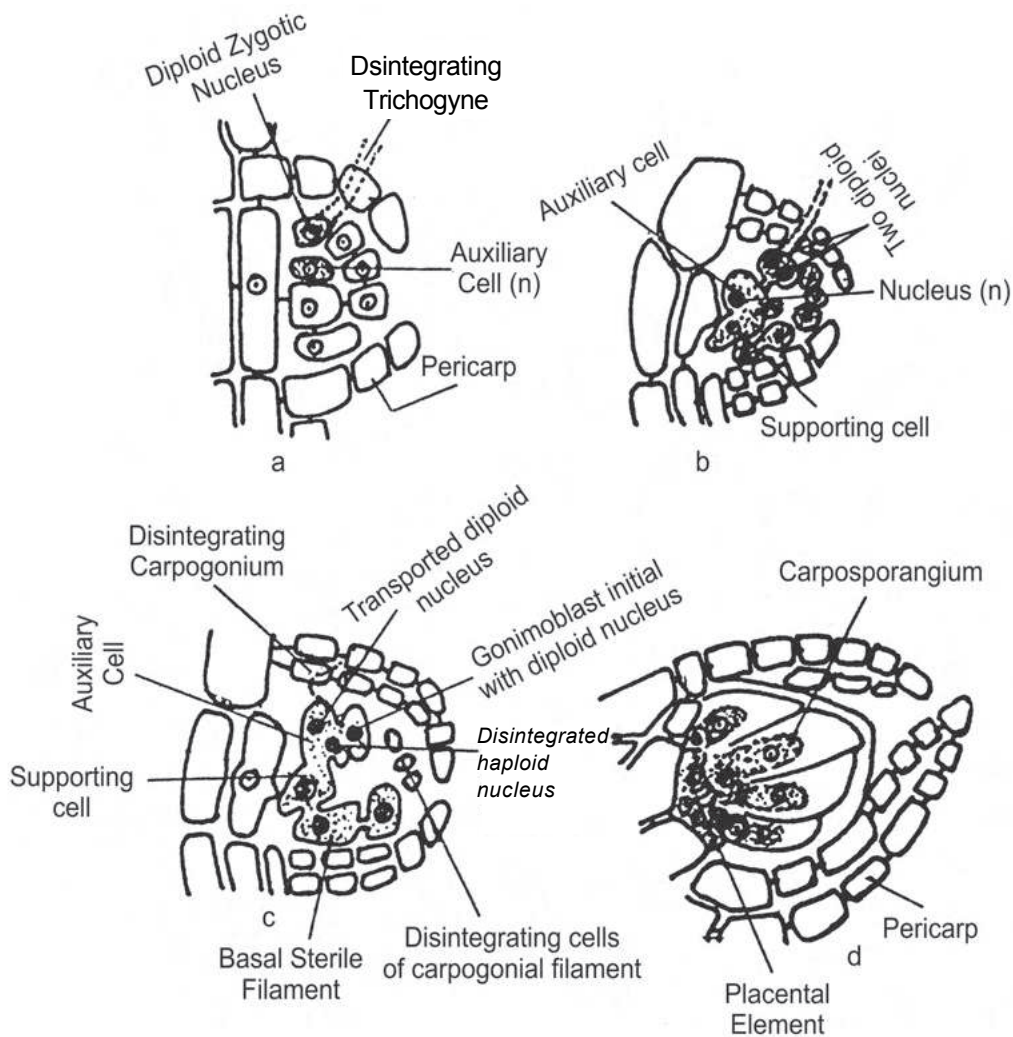

Figs. 2.32 : Post fertilization changes leading to the development of carposporophyte in *Polysiphonia*.

- vii) **2.7.2.6 Carposporophyte:** The cystocarp bearing plant of *Polysiphonia* is known as carposporophyte. The cystocarp develops carpospores within, which are released outside through the ostiole. The carpospores germinate to form another diploid stage of the life cycle called tetrasporophyte. (Figs. 2.33)

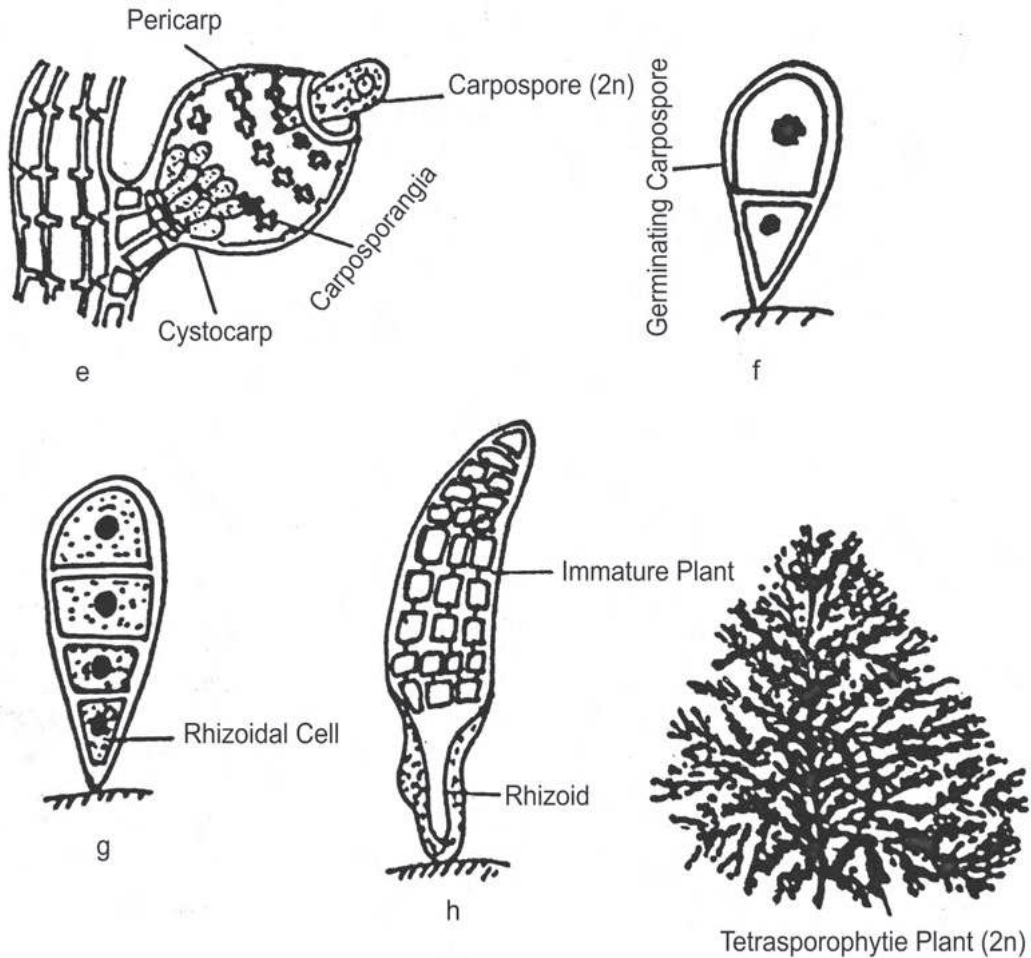

Figs. 2.33 : Release of Carpospore from cystocarp and its germination to produce tetrasporophyte (2n).

- viii) **2.7.2.7 Tetrasporophyte:** It is a free living independent stage in the life cycle. The thallus of the tetrasporophyte resembles the gametophytic plant. The matured tetrasporophyte is diploid and it bears diploid tetrasporangia on maturity. The diploid nucleus of the tetrasporangium undergoes meiosis and forms four haploid nuclei. Each of the nuclei differentiates into haploid tetraspore. The liberated

tetraspore germinates and gives rise to haploid gametophyte plant body concerned with the sexual reproduction. In this way life cycle of *Polysiphonia* continues. (Fig. 2.34)

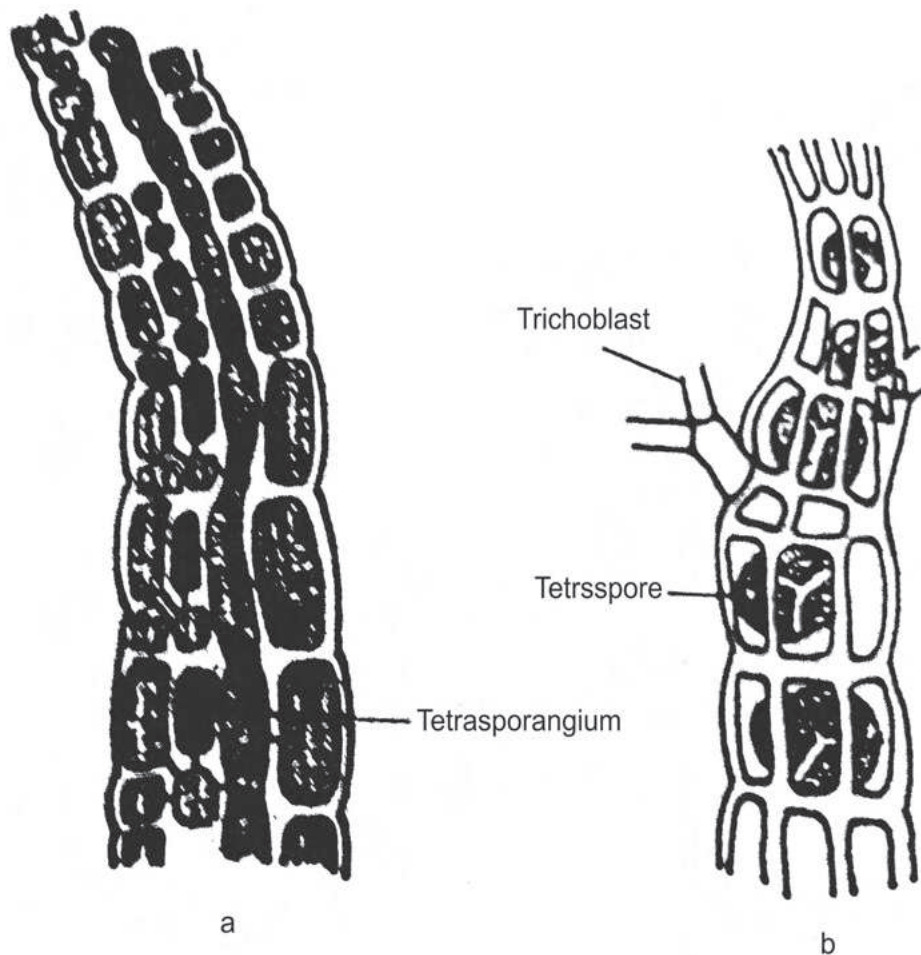

Fig. 2.34 : Structure of tetrasporophytic plant of *Polysiphonia*.

2.8 □ Economic importance of algae

Algae have wide range of economic value. It could be used in the production of industrially important compounds other than its use as food, fodder, medicine, fertilizer etc. In plant physiological research algae are frequently used as experimental materials. The different field of applications of algae are highlighted below:

2.8.1 Algae as food

Algae mostly belongs to the Phaeophyceae and Rhodophyceae are used as food by the people of different parts of the world. Few species of Chlorophyceae and Cyanophyceae are also used as food because they possess minerals, vitamins in their cell wall as well as in the cytoplasm. Algal foods are not only rich in nutrients but these are delicious too. Different algal foods and their sources are given below:

Name of the food/ Trade name	Source	Country where food is used
1. Kombu	<i>Laminaria</i> (Phaeophyceae)	Japan
2. Sarumen	<i>Alaria</i> (Phaeophyceae)	Japan
3. Cachiyago	<i>Durvillea</i> (Phaeophyceae) (Alga is collected, dried and salted to prepare the food)	South America.
3. Dulse	<i>Rhodymenia palmata</i> (Rhodophyceae)	Canada
4. Nori	<i>Porphyra sp.</i> (Rhodophyceae)	Japan
5. Aonori	<i>Monostroma</i> (Chlorophyceae)	Japan
6. Cachiyago	<i>Ulva</i> (Chlorophyceae)	Japan, South America.
7. Yuyucho	<i>Nostoc commune</i> (Cynaophyceae)	China, Java

2.8.2 Agar agar

It is a polysaccharide obtained from the cell wall of red algae. Agar is made up of two components such as agarose and agaropectin. The agar producing algae are called agarophytes (e.g. *Gelidium amansii*, *G. foliaceum*, *G. allanii*, *Gracilaria*, *Gigartina*, *Phyllophora*, *Pterocladia* etc. It is used as a solidifying agent of culture medium prepared for the cultivation of microorganisms like fungi, bacteria etc. Agar can be used as a laxative. It is also used in packing canned foods, in treatment of constipation. In cosmetic and leather industry use of agar is very common. In textile and paper industry agar is used for sizing paper and fabrics. Agar is also used in making ointments and pills. Physicians use dried agar powder for the treatment of prolapsed stomach.

2.8.3 Carrageenin

It is a polysaccharide found in the cell wall of red alga *Chondrus crispus* (Irish moss). Carrageenin is also extracted from *Gigartina*. Medicinally carrageenin is important since it is used by physicians as blood coagulant. Besides, it is used in the preparation of tooth paste, paints, cosmetics etc. Carrageenin is also used in textile, leather, and pharmaceutical industry. As a clearing agent it is used to clean juices, liquors, beet sugar etc.

2.8.4 Alginates

Alginic acid also called algin or alginate is another economically important carbohydrate obtained from the cell wall of some Brown algae. The empirical formula of alginic acid is $(C_6H_8O_6)_n$. It occurs in the middle lamella and primary cell wall of some members of Phaeophyceae. It is obtained from algae like *Laminaria*, *Ascophyllum*, *Macrocystis*, *Ecklonia*, *Loossonia*, *Fucus* etc. Alginates are used in paints, rubber industry, ice cream. It is also used in the preparation of flame proof fabrics and plastic articles. Alginic acid could be applied to stop bleeding effectively. Alginic acid derivatives are also used in the preparation of soups, creams, sauces etc.

2.8.5 Funori

It is a type of glue obtained from the members of Rhodophyceae like *Gloiopeltis furcata*, *Chondrus* etc. It is used as a sizing agent for paper and cloth. In Japan funori prepared from the algae are used as good quality adhesive.

2.8.6 Use of algae as fodder

Some members of Phaeophyceae, Rhodophyceae and green algae are used as food for animals especially in the coastal countries. Stock feed and commercial feed for domestic cattle are prepared using different species of *Laminaria*, *Ascophyllum*, and *Fucus*. In Japan *Pelvetia* is used as a cow feed. The butter fat content of the milk is enhanced due to such feeding. Meal prepared from *Ascophyllum* and *Fucus* helps to increase the iodine content of egg of hens. Many fishes use diatom as their food. A fish named Tilapia uses only the members of Blue green algae as well as green algae as their food. *Macrocystis* is very rich in vitamin A and E. Due to high vitamin content it is used as cattle feed. In France *Rhodymenia* is used as common cattle feed.

2.8.7 Role of algae as biofertilizer

The members of Cyanophyceae are used as biofertilizer because of their ability to fix atmospheric nitrogen in the soil. In the members of Cyanophyceae the vegetative cell is modified to heterocyst which is considered as the ideal site for nitrogen fixation. Nitrogenase enzyme in such structure remains protected from oxygen toxicity and therefore could effectively cause nitrogen reduction. The inoculum of the Cyanophycean members (like *Nostc*, *Anabaena*, etc.) is propagated in presence of adequate phosphate source and to some extent alkaline environment to obtain huge biomass. Such biomass is dried and used as biofertilizer. The addition of algal inocula in the agricultural field in the form of biofertilizer to enhance the fertility is known as **algalization**. Due to algalization the productivity of rice could be enhanced 30% or more. Besides the members of Cyanophyceae, other algal genera could be applied in the agricultural field as manure. The genera like *Lithophyllum*, *Lithothamnion*, *Chara* etc, has been reported to add calcium in the agricultural field. Thus calcium deficient soil could be treated with the cultivation o these algae. Irish people use *Fucus* as common manure. It has been reported that *Abelmoschus esculentus* becomes more productive if seaweed manure is used.

2.8.8 Diatomite

The members of Bacillariophyceae are known as diatom. The cell wall is thick rigid and highly silicified. The cell wall of diatom is known as frustules. After the death of the cell the frustules accumulate at the bottom of the sea. Due to accumulation of frustules year after year at the bottom of the sea a heap of frustules is formed. Such accumulated mass of cell wall of diatoms is known as diatomaceous earth. As it is indestructible in nature, diatomaceous earth is taken out from the bottom of sea in the form of a brick like pieces. Such pieces are dried and ground in the form of a fine whitish powder known as diatomite. The diatomite has the following economic values:

a) It is used in the sugar refinery and other industrial filtration process. b) It is used as car and silver polishing powder. c) Brick like pieces are made from diatomite which is affixed on the wall of the room to maintain its temperature constant. d) As a refining material diatomite is used in brewing industry. e) Diatomite is also applied in the preparation of bleaching powder. f) According to Round (1973), Alfred Nobel used diatomite as an absorbent for nitro-glycerine in the manufacture of dynamite. g) The diatomite is sprinkled on the floor and wall of the coal mines to reduce the possibility of secondary explosion. h) The powder of diatomite is also used as adulterant in the flour.

2.8.9 Role of algae in the production of medicine

Algae has enormous importance in medicine. Marine algae have antioxidant compounds in their vegetative body which help to fight against diseases like cancer, chronic inflammation, atherosclerosis and cardiovascular disorder. Phlorotannin, a polyphenol obtained from marine brown algae has potential free radical scavenging property. Phylophaeophytin is obtained from the brown algae *Eisenia bicyclis* is very important compound having potential antioxidant properties. Chlorellin obtained from *Chlorella* has antibiotic property effective against gram positive and gram negative bacteria. Compounds having antibacterial property have also been isolated from algae like *Ascophyllum nodosum*, *Laminaria digitata*, some species of *Polysiphonia* and *Pelvetia*. Similarly, antibiotic effective against *E. Coli* has been reported from diatom *Nitzschia palea*. An antihelminthic drug known as “*Tse-ko-Tsoi*” is prepared from *Digenia simplex* in south China. Fucoidin and laminarin sulphate obtained from some brown algae are used as anticoagulant of blood. Spirulina capsule sold in the market is a rich source of protein and made up of dried cell mass of *Spirulina platensis* (Cyanophyceae). It is given to the patients who suffer from protein deficiency diseases.

2.8.10 Role of algae in sewage disposal

Algae play significant role in sewage disposal. Sewage contains huge amount of industrial and organic wastes. The removal of such wastes requires aerobic digestion with the involvement of aquatic microorganisms. The growth of aerobic microorganisms requires excessive oxygen supply. The rapid growth of algal biomass adds oxygen to water bodies and facilitates the growth of aerobic degrader. In this way algae helps to dispose waste from sewage.

2.8.11 Role of algae in land reclamation

The barren land could be converted into fertile cultivable land by cultivation of algae. The growth of blue green algae on soil surface prevents soil erosion. Not only that growth of Cyanophyceae on disturbed or burnt soil adds huge nitrogen that makes the land fertile and cultivable.

2.8.12 Industrial importance of algae

Dunaliella salina is an alga belongs to the class Chlorophyceae which has been proved as an enriched source of intracellular β -carotene. This alga could be exploited for industrial production of **β -carotene**. Microalgae mostly belonging to Chlorophyceae are used in the production of **biodiesel** due to their rapid growth rate and high biomass production. As a part of photosynthesis process algae produce oil and can produce 15 times more oil per acre than other plants used as biofuels. The oil press method and supercritical fluid method is used for extraction oil from algal biomass. The extracted oil is refined using transesterification technique.

2.8.13 Negative aspects

Due to luxuriant algal growth in water reservoir the taste of drinking water becomes foul. The growth of huge algal mass interferes with the filtration process. The growth of some algae in lake and pond water releases some toxins which make the water body unfit for the survival of aquatic animals including fishes. *Microcystis aeruginosa*, *M. toxica* etc. are examples of algae which cause poisoning of aquatic animals by secretion of a toxin known as microcystin. The growth of Dinoflagellates like species of *Gymnodinium*, *Gonyaulax*, *Pyrodinium* etc. are also responsible for the death of fishes, shellfishes and some other aquatic animals. *Gonyaulax catanella* is an endotoxin producing alga which is not at all harmful for fishes which ingest it. But such accumulated toxin inside the fishes may cause death of the persons who eat such fishes. *Lyngbya majuscula* produces antillatoxin and kalkitoxin in the swimming pool which is the cause of seaweed dermatitis of swimmers. Sometimes profuse growth of some microscopic and semi-microscopic algae (mostly Dinoflagellates and Cyanophyceae) in water body develop a condition that causes suffocation to the animals living in that water, exerts deleterious effects to the aquatic animals and also cause emission of foul odour from the concerned area. Such a condition is known as **algal bloom**.

2.9 □ Summary

Algae constitute a large group of thallophytic cryptogams. They are Photosynthetically metabolizing organisms that reproduce both asexually and sexually. Sexual reproduction is either isogamous or anisogamous or oogamous. Life cycle patterns are three types — haplontic, diplontic or haplo-diplontic. Thallus range is varied and some show heterotrichous form. *Nostoc* is a cyanophyceous alga which fixes atmospheric nitrogen. They are prokaryotes

showing specialized structures called heterocyst and akinetes. *Oedogonium* has long unbranched thallus and shows two forms : Macrandrous and Nannandrous. Nannandrous forms show dwarf male filaments. *Polysiphonia* has heterotrichous structure. It is dioecious and hetrothallic. It produces carpogonium as a part of sexual reproduction. The post fertilization developments result in formation of a carposporophyte. Algae are producers in ecological pyramid. They produce many important compound which are commercially exploited. They are also used as food, fodder and biofertilizers.

2.10 □ Exercises

Objective multiple choice questions

1. In which of the following algae cystocarp is found? – a) *Ulothrix* b) *Volvox* c) *Polysiphonia* d) *Spirogyra*.
2. Which of the following algae is used as fodder? – a) *Volvox* b) *Spirogyra* c) *Laminaria* d) *Ulothrix*
3. Which of the following algae is the source of agar? – a) *Chondrus* b) *Gelidium* c) *Laminaria* d) *Spirulina*.
4. Name one parasitic alga. – a) *Cephaleuros parasitica* b) *Laminaria digitata* c) *Chondrus crispus* d) *Chlamydomonas braunii*.
5. Which alga is found in the gametophyte of *Anthoceros*?- a) *Chlamydomonas* b) *Nostoc* c) *Laminaria* d) *Trentepohlia*.
6. Reproduction by formation of hormogonium occurs in – a) *Lyngbya* b) *Gloeocapsa* c) *Microcystis* d) *Scytonema*.
7. Coenocytic filament is found in – a) *Zygnema* b) *Spirogyra* c) *Vaucheria* d) *Polysiphonia*.
8. Mucopolysaccharide is found in the class – a) Chlorophyceae b) Cyanophyceae c) Rhodophyceae d) Bacillariophyceae.
9. 'Kombu' - a type of food is produced from – a) *Fucus* b) *Caulerpa* c) *Laminaria* d) *Porphyra*.
10. Alginate is obtained from the cell wall of – a) Red alga b) Diatom c) Brown alga d) BGA.

11. The only prokaryotic algal class is – a) Chlorophyceae b) Rhodophyceae c) Cyanophyceae d) Xanthophyceae.
12. The term receptive spot is associated with – a) Antheridium b) Oogonium c) Nannandrium d) Zoosporangium.
13. Apical cap is found in – a) *Oedogonium* b) *Chara* c) *Ectocarpus* d) *Laminaria*.
14. The type of alternation of generation in Phaeophyceae is a) Haplontic b) Diplontic c) Diplohaplontic d) Haplohaplontic.
15. Sexual reproduction is absent in : a) Cyanophyceae b) Chlorophyceae c) Xanthophyceae d) Phaeophyceae.
16. Triphasic alternation of generation is found in: a) *Porphyra* b) *Polysiphonia* c) *Chara* d) *Chlamydomonas*.
17. Which of the following is the largest alga? a) *Ectocarpus irregularis* b) *Giffordia conifera* c) *Macrocystis pyrifera* d) *Porphyra tenela*.
18. Which of the following statement is correct for the zoospore of *Oedogonium* – a) Biflagellate and whiplash type b) Multiflagellate and whiplash type c) It is multiflagellate and tinsel type. d) Whiplash flagella, many in number form a ring towards the apical region of zoospore.

Answers: 1(c), 2(c), 3(b), 4(a), 5(b), 6(a), 7(c), 8(b), 9(c), 10(c), 11(c), 12(b), 13(a), 14(c), 15(a), 16(b), 17(c), 18(d).

Answer the following questions:

1. Comment on the life cycle patterns in algae. . [Ans. See section 1(k)]
2. What is heterocyst? How does heterocyst differ from vegetative cell? . [Ans. See section 2.4.1(b)]
3. Draw and describe the life cycle of nannandrous species of *Oedogonium*. . [Ans. See section 2.5.3.3(b)]
4. Characterise the female gametophyte of *Polysiphonia*. . (Ans. See section 2.7.2.3)
5. What is carposporophyte? Describe the events of post fertilization changes in *Polysiphonia*. . (Ans. See section 2.7.2.5)

6. Write a short note on the use of algae as food. . (Ans. See section 2.8.1)
7. What is agar? Mention its source and uses. . (Ans. See section 2.8.2)
8. How algae could be exploited as biofertilizer? . (Ans. See section 2.8.7)
9. What is diatomite? Mention the economic importance of diatomite. . (Ans. See section 2.8.8)
10. Name one alga producing beta carotene. . (Ans. See section 2.8.12)
11. Write a short note on toxic algae and its harmful effect. . (Ans. See section 2.8.13)
12. Write a note on the use of algae as fodder. . (Ans. See section 2.8.6)
13. What is alginate? Mention its source and uses. . (Ans. See section 2.8.4)
14. What is carrageenin? Mention its source and uses. . (Ans. See section 2.8.3)

Unit 3 Fungi

Structure

- 3.0 Objective
- 3.1 Introduction
- 3.2 General characteristics
- 3.3 Reproduction in fungi
 - 3.3.1 Vegetative reproduction
 - 3.3.2 Asexual reproduction
 - 3.3.3 Conidial fructification
 - 3.3.4 Asexual spores related to sexual reproduction
 - 3.3.5 Sexual reproduction in fungi
 - 3.3.6 Sexual spores
- 3.4 Life cycle of *Penicillium*
 - 3.4.1 Vegetative structure
 - 3.4.2 Reproduction
- 3.5 Life cycle of *Agaricus*
 - 3.5.1 Vegetative body
 - 3.5.2 Reproduction
- 3.6 Mycorrhiza
 - 3.6.1 Ectomycorrhiza
 - 3.6.2 Endomycorrhiza
 - 3.6.3 Ectendomycorrhiza
- 3.7 Summary
- 3.8 Exercises

3.0 Objective

Fungi are saprophytic and from this unit you will be able to learn about the structure, reproduction and importance of fungi.

3.1 Introduction

Thallophytes have evolved in two separate lines. In one evolutionary line green photosynthetic algae have evolved whereas in the other non photosynthetic chlorophyll less plants fungi have evolved. Due to great variability in characters it is very difficult to give a precise definition of fungi. The diagnostic characters by which this group plants could be identified and distinguished are summarized as follows:

- a) Fungi exhibit heterotrophic and absorptive mode of nutrition.
- b) Thallus may develop inside or outside the substratum. When parasitic growth of the thallus is found on the surface of the plant or animal it is called epibiotic. If such growth occurs inside the plant cell or animal, it is called endobiotic. Thallus may be plasmodial amoeboid or pseudoplasmodial (Myxomycota). Sometimes may be unicellular and usually filamentous. Where the vegetative body is filamentous the filament is called mycelium. Mycelium may be septate(e.g. *Aspergillus*) or aseptate(e.g. *Rhizopus*). Some unicellular forms are motile (e.g. *Synchytrium*).
- c) Cell wall is well defined typically chitinised (cellulosic in Oomycetes).
- d) Cells are eukaryotic.
- e) Life cycle may be of simple or complex type.
- f) Distribution is cosmopolitan. Members may be saprophyte, symbionts, parasite or hyperparasites.

After going through this chapter learners can understand the extent of diversity exists within the fungi. They will be able to distinguish this group of plants from other plants which are also thallophytes. Learners will be able to acquire knowledge about the different modes of reproduction prevails in this group of plants. Also they would acquire knowledge about the application of those organisms in human welfare.

3.2 □ General characteristics

The kingdom Fungi is divided into two major divisions, one is Myxomycota and the other is Eumycota or True fungi. The members of Myxomycota are wall less. The vegetative body is multinucleate protoplasm exhibiting amoeboid movement and called plasmodium. In some cases vegetative body is an aggregation of separate amoeboid cells called

pseudoplasmodium. Due to their slimy consistency, the plasmodium and pseudoplasmodium are called slime molds. The general characteristics of the members of **Eumycota or true fungi** are described below:

- i) **Thallus organisation:** In yeast or yeast like fungi thallus is unicellular (e.g. *Saccharomyces*, *Sporobolomyces*). In majority of fungi the vegetative body is made up of filaments called hyphae. The thallus made up of hyphae is expressed in a collective term called mycelium. The thallus may be differentiated into a vegetative part which absorbs nutrients and a reproductive part. Such thallus organization is called as **eucarpic**. In others, the thallus is vegetative but during reproduction the entire thallus is converted into a reproductive structure. Such thallus is called **holocarpic**. In certain parasitic fungi the entire thallus lives inside the host cell and during reproduction the entire thallus is converted into reproductive organ (eg. *Synchytrium*, *Olpidium*). Some fungi pathogenic to animals produce yeast like phase in the life cycle due to conversion of its usual filamentous form, depending upon the environmental conditions like CO₂ concentration and medium composition etc., such phenomenon is known as **dimorphism** (e.g. *Penicillium marneffei*). The mycelium may be **septate** or without any septa (**aseptate**). In the members of the class Oomycetes and Zygomycetes, the septa are generally absent in the hyphae whilst in Ascomycetes, Basidiomycetes and Deuteromycetes the hyphae are usually septate. Since crosswall or septum is absent in aseptate forms the nuclei are freely distributed in the cytoplasm of the hyphae. Such a condition is described as **coenocytic**. In case of septate mycelium, each cell may contain a single, haploid nucleus; such mycelium is known as **monokaryotic** mycelium. In Basidiomycetes, each cell of the mycelium contains two genetically distinct haploid nuclei; such mycelium is known as **dikaryotic** mycelium. Mycelium produced as a result of the germination of basidiospore is known as **primary mycelium**. The mycelium arises by dikaryotization of cells of the primary mycelium is known as **secondary mycelium**. The dikaryotization of the monokaryotic mycelium in some members of Basidiomycetes takes place with the help of another dikaryotic mycelium, this phenomenon is known as **Buller phenomenon**. The dikaryotic mycelium which is involved in the formation of fruit bodies is designated as **tertiary mycelium**.(Fig.3.1)

In majority of the members of basidiomycotina, the dikaryotic mycelium grows following the process called **clamp connection**. During this process two nuclei of the dikaryotic mycelium divide and produce four daughter nuclei. A septum is then formed which separates the daughter nuclei into two compartments, the upper compartments bears two nuclei of

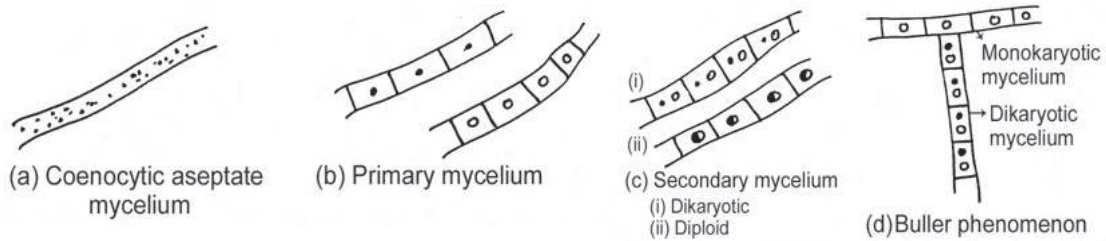

Fig. 3.1. Different types of mycelium (a-c) (d) dikaryotization of a monokaryotic mycelium with the help of a dikaryotic mycelium (Buller phenomenon).

opposite polarity whereas the lower one bears one nucleus of any one polarity. A lateral clamp is produced simultaneously from the upper compartment to which one nucleus migrates, the polarity of which is opposite to the single nucleus present in the lower compartment. The clamp gradually proceeds towards lower compartment as presented in the figure (Fig 3.2) and ultimately fuses with it to pass the nucleus present within it. Two daughter cells of dikaryotic nature thus produced.

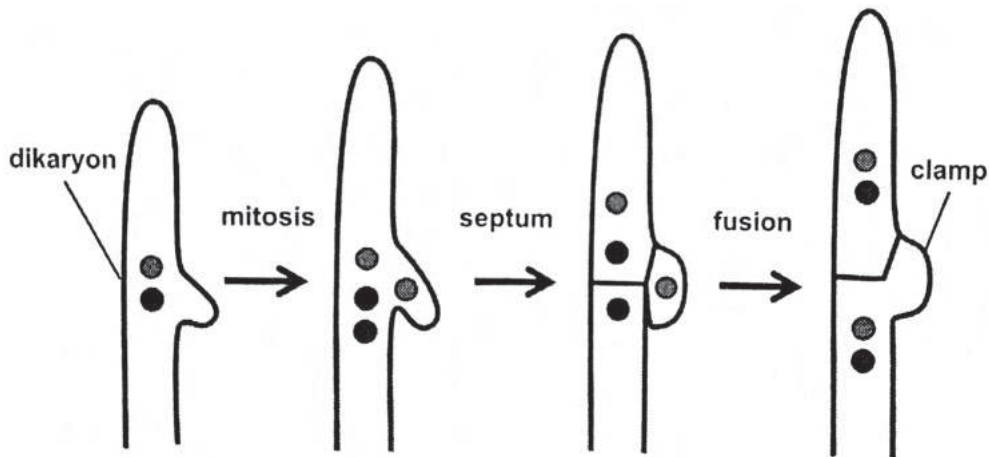

Fig. 3.2. Steps of mycelial growth by clamp connection.

Aggregations of hyphae: Fungal mycelia are aggregated to form various organized structures commonly called fungal tissue or plectenchyma. Fungal tissues are of two types such as: 1. **Prosenchyma or prosoplectenchyma** and 2. **Pseudoparenchyma or paraplectenchyma**. In the former type the hyphae compactly grow together in a parallel manner so that the individuality of the hyphal threads and their elongated cells are retained (**Fig 3.3 a**). In the latter type the compactness of the hyphae are so much that the individuality of each thread is lost and when a cross section is made through the tissue it appears as aggregation of parenchymatous tissue (**fig 3.3 b**).

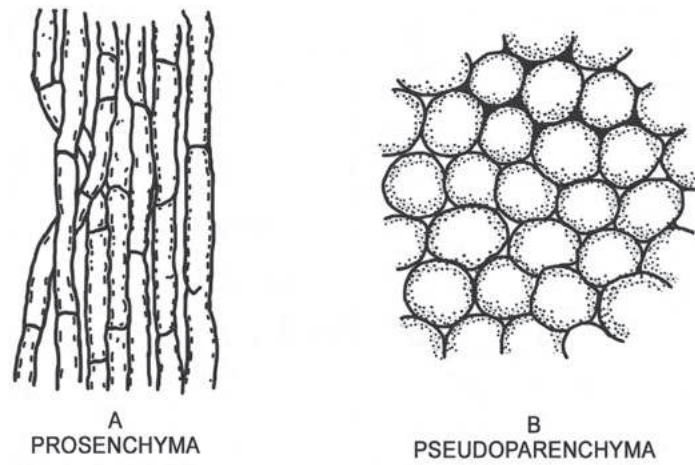

Fig. 3.3. Different form of aggregation of mycelia in fungi. A. Prosenchyma, B. Pseudoparenchyma.

Sclerotium : It is dark brown or black, tough, cushion shaped resting body made up of pseudoparenchymatous tissue. The inner cells are hyaline and filled with reserve food whereas the outer cells are thick walled. Depending upon their size sclerotia are classified as micro (small microscopic) and macro (large visible in naked eye) sclerotia. Sclerotium germinates under favourable condition and produces pin head like bodies differentiated into two parts; the stipe (stalk) and sphaeridium (head). Reproductive structures are developed inside the sphaeridium (e.g. *Claviceps*). (**Fig3.4**)

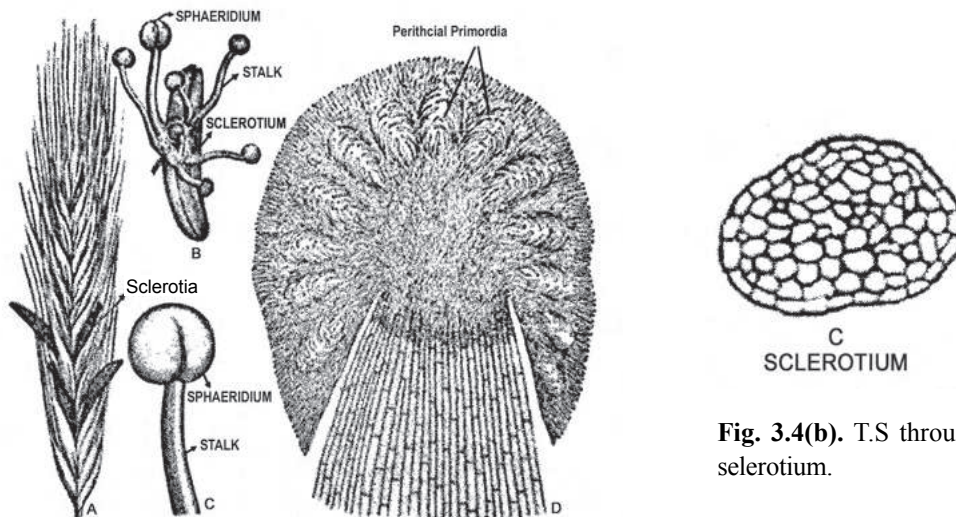

Fig. 3.4(b). T.S through a sclerotium.

Fig. 3.4(a). *Claviceps purpurea*. A. Sclerotia on inflorescence of rye. B. Germinating sclerotium showing stalked sphaeria. C. A single stalked sphaeridium. D. Section through a sphaeridium showing primordia of perithecia.

Stroma (plural: stromata): It is solid organization made up of prosenchyna or pseudoparenchyma. Reproductive structures or fructifications commonly develop inside this structure (e.g. *Daldinia*). (Fig.3.5)

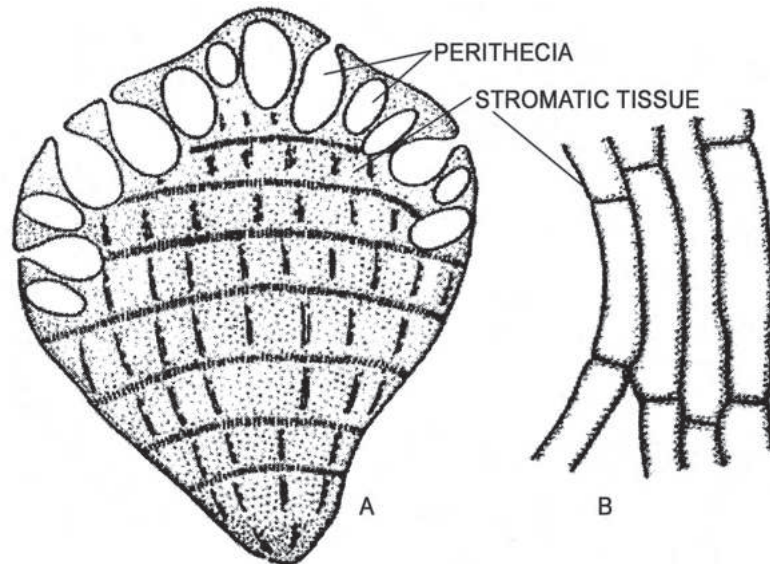

Fig. 3.5. Stroma. A, section through a stroma; B, structural detail of stroma.

Rhizomorph: It is a root like hyphal organization with well developed apical meristem and a central core of larger thick walled elongated cells. The entire structure remains covered by a rind made up of smaller thick walled darkly pigmented cells. This structure is observed in honey fungus or honey agarics named as *Armillariella mellea* (= *Armillaria mellea*). There are two kinds of rhizomorphs such as one dark, cylindrical type and the other paler, flatter type. The latter type is found beneath the bark of infected tree. Rhizomorphs are also found in dead tree and their diameter may be upto about 4 mm. They help the fungus to spread from root system of one host to another. (Fig 3.6 A & B)

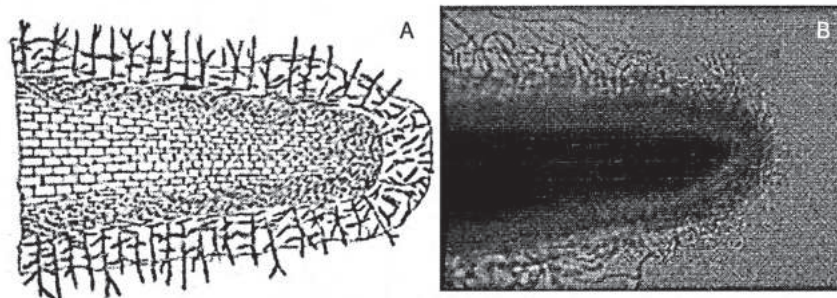

Fig. 3.6 A & B. Ultrastructure of rhizomorph.

- ii) **Cell structure:a) Cellwall :** Chemical analysis of the fungal cell wall reveals that the major component of cell wall is polysaccharide (80-90%) and the remainder consisting of protein and lipid. Chitin is the major polysaccharide found in most fungal cell wall, but cellulose is present in cell wall of Oomycetes along with glucan. Chitin is a polymer of N-acetyl glucosamine whereas cellulose is a polymer of D- Glucose. (**Fig 3.7**) .Cell wall which form septa in hyphae may

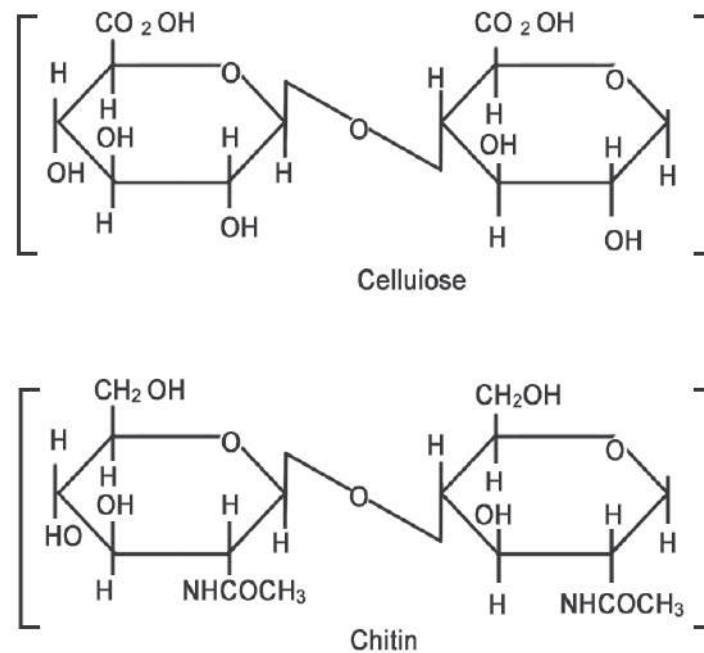

Fig. 3.7. Structural formula representing the units of cellulose and chitin.

be of three types such as: septum that delimits the reproductive structure without having any perforation, transverse septum with simple perforation lying at right angle to the axis of the hypha(found in Ascomycetes and Deuteromycetes) and transverse septum with complex perforation(found in Basidiomycetes).In case of complex perforation surrounding the central pore of the septum there is a curved flange of wall material which is often thickened to form a barrel shaped or cylindrical structure. Such type of septum is known as **dolipore** septum (**fig 3.8 A & b**).

- b) **Cytoplasmic membrane:** Like other eukaryotes the plasmalemma of fungal cell shows fluid mosaic structure of a typical unit membrane. Typical invagination of plasmalemma is observed which is called lomasome. In

between the cell wall and indented region of plasma membrane many discrete vesicles of spherical, ovoid and tubular shapes are found. Such vesicles may be derived either from the passage of vesicles through the plasmalemma or by the proliferation or budding off of the vesicular structure from the plasmalemma. The former and the latter origin are described as **true lomasome** and **plasmalemmasome** respectively.

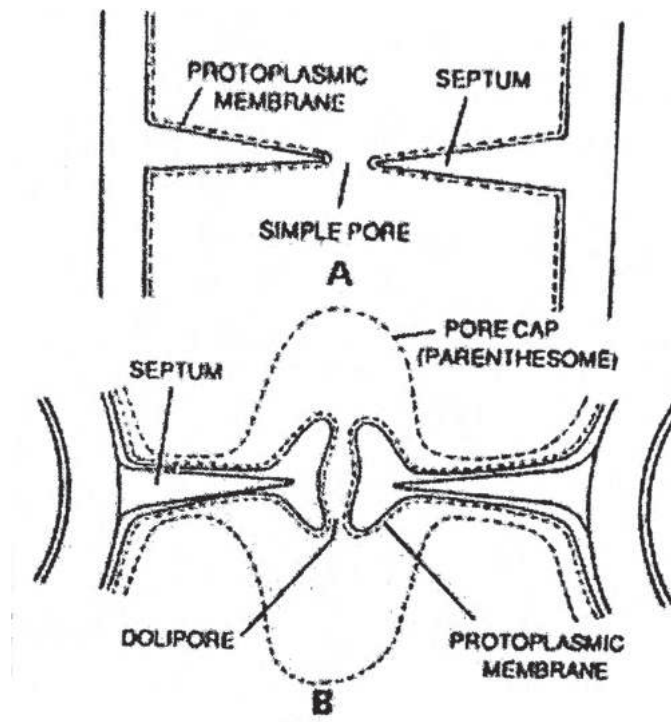

Fig. 3.8. Septal pores in fungi. A. simple pore; B dolipore in many Basidiomycetes.

- c) **Cytoplasm:** Apart from chloroplast the cytoplasm of a fungal cell contains familiar organelles characteristics of eukaryotic cell. Nucleus is surrounded by double membrane continuous with endoplasmic reticulum. The nuclear membrane is interrupted with numerous pores. When mitotic cell division occurs, the nuclear membrane does not always break down but may constrict in the middle to separate two sister nuclei. This process is known as **karyochoresis**. The structures of cellular organelles like mitochondria, ribosome, microbodies, vacuoles, lysosomes, microtubules etc. are more or less similar to other eukaryotic cells. A wide variety of cytoplasmic inclusions are found in the cell such as glycogen aggregates, carotenoid crystals, fatty

acid synthetase body, sphaerosomes (lipid bodies) etc. In filamentous Ascomycota, a peroxisome derived dense core microbody with a unit membrane is found near the septae which is called **Woronin body**. It plugs the septal pore after hyphal wounding and restricts the loss of cytoplasm to the sites of injury. (Fig 3.9)

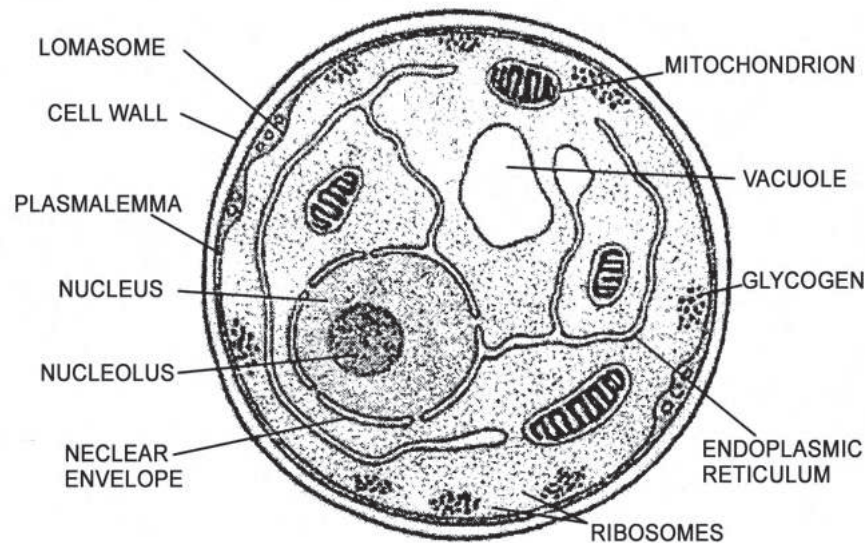

Fig. 3.9. Structural details of a fungal cell.

3.3 □ Reproduction in fungi

In fungi vegetative, asexual and sexual methods of reproduction are recognized.

3.3.1 Vegetative reproduction

It takes place by different methods like fragmentation, budding and fission. In fragmentation the mycelium is separated into many pieces, and each segment grows into a new individual. Small bud like protuberances developed from mother cell in the process and known as budding. In yeast buds are formed in chains, each of them being separated from mother cell gives rise to new individual. When a vegetative cell simply splits into two daughter cells by development of transverse wall, the process is known as fission. (Fig 3.10 A & B)

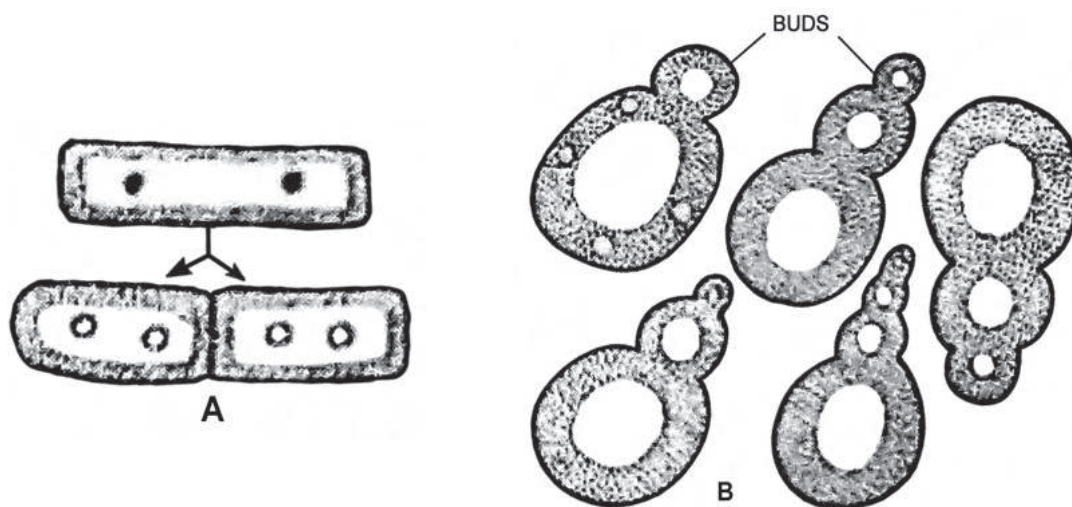

Fig. 3.10. A. Vegetative reproduction in fungi by binary fission. B. Vegetative reproduction by budding.

3.3.2 Asexual reproduction

Spore is the unit of asexual reproduction. In fungi different types of spores are produced. Spores are broadly classified into three categories such as: asexual spores; asexual spores related to sexual reproduction and spores produced as a result of sexual reproduction that is sexual spores. (**Word diagram 3.1**) The structural description of different types of spores is given below.

Sporangiospore : the spores produced inside the sporangia are called sporangiospores. The sporangium is a sac like structure within which spores are produced. The spores produced in the sporangium may be motile or non motile and based on this criterion the sporangiospores are of two types:

- a) **Aplanospore**: These are non motile spores without any device for locomotion. The aplanospore producing sporangia are called aplanosporangia. The number of spores in aplanosporangia is variable. A few spored sporangia where spores are dispersed as a unit, such sporangia are called **sporangiola**. Aplanospores may be uni or multinucleate, smooth walled, globose or ellipsoid in shape. This type of spore production is the characteristic of Zygomycotina, specially the Mucorales. (**Fig 3.11**)

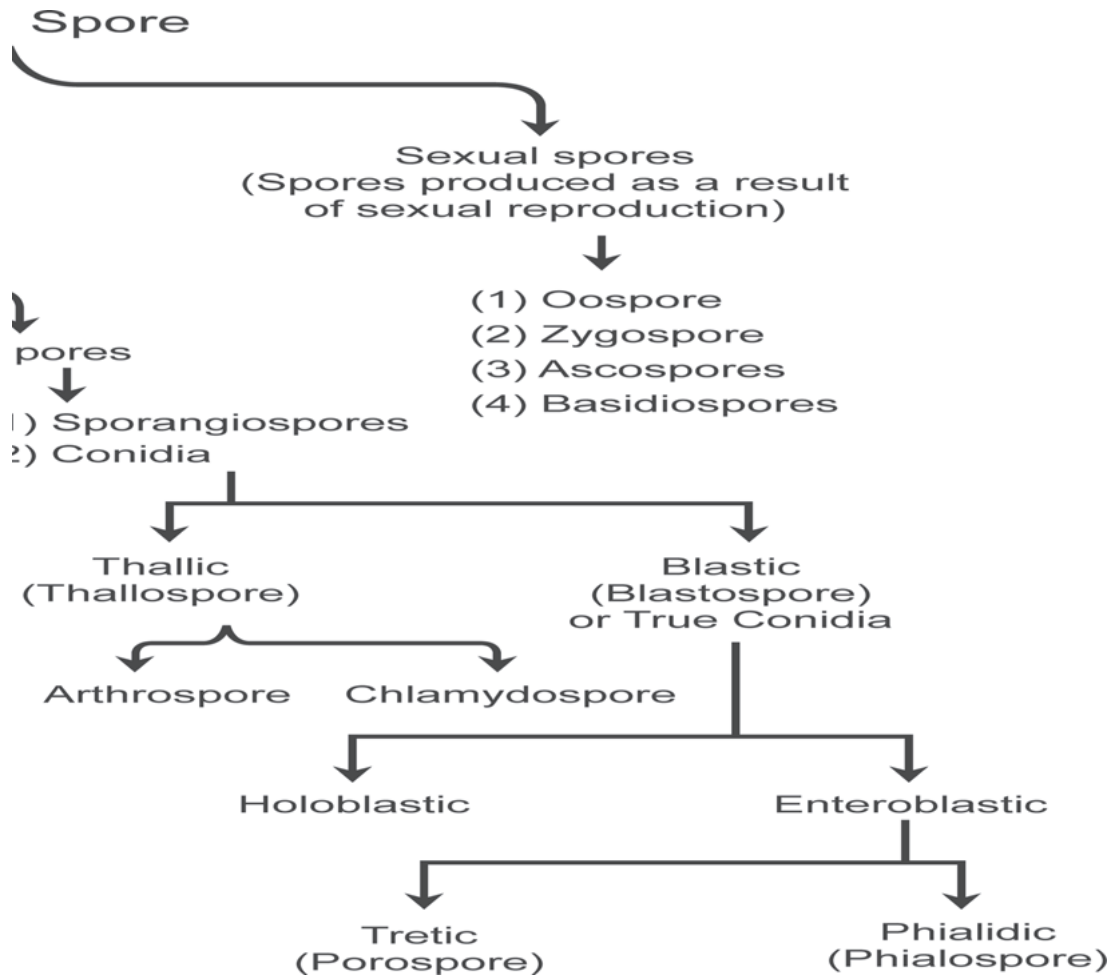

Word diagram 3.1

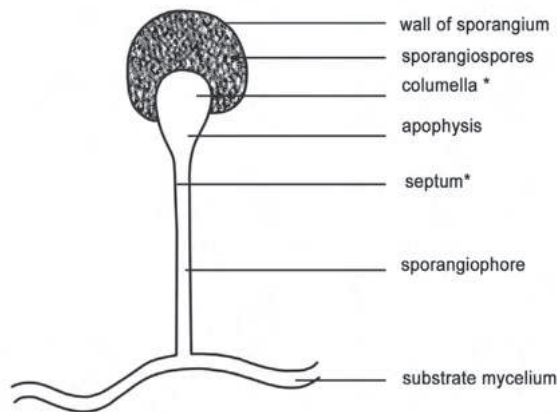

Fig. 3.11. Structure of sporangium containing sporangiospore.

- i) **Zoospore:** Zoospores are motile spores produced in the structure called zoosporangium. Flagellum is the device of motility of zoospore. Each flagellum is made up of a central axoneme from which numerous small hairs or mastigonemes are produced. Within Eumycota, zoospores are of three types: posterior uniflagellate zoospores with flagella of whiplash type, anteriorly uniflagellate zoospores with flagella of the tinsel type and biflagellate zoospores with anteriorly or laterally inserted flagella- one of which is tinsel type and the other is whiplash type. The term **heterokont** is used where one flagellum is of whiplash type and the other is of tinsel type. The flagellum originates from a basal body called **kinetosome or blepharoplast**. In some uniflagellate zoospores (e.g. *Blastocladiella emersonii*) the kinetosome is closely associated with a mitochondrion. Three striated bodies establish connection between the kinetosome

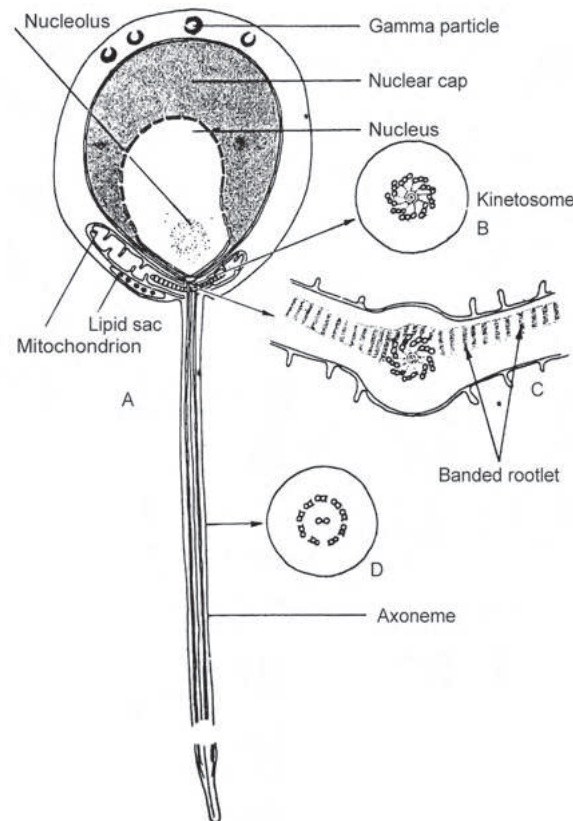

Fig. 3.12. *Blastocladiella emersonii* : zoospore structure (diagrammatic). A. L. S. zoospore along axis of flagellum. B. T. S. kinetosome showing nine triplets of subfibrils. C. T. S. kinetosome at slightly lower level showing the origin of two of the banded rootlets which extend into the mitochondrion. The cristae of the mitochondrion are shown close to the membrane which surrounds the banded rootlets. D. T. S. axoneme showing the nine peripheral paired subfibrils and two central fibrils.

and the mitochondrion which are called **flagellar rootlets, striated rootlets or banded rootlets**. This adaptation is to provide uninterrupted energy supply to maintain flagellar dynamism. In tinsel type of flagella the main flagellar axis or axoneme remains covered with **flimmer hairs** or mastigoneme which are not at all the components of microtubules of flagella. The axoneme shows typical 9+2 arrangement of flagellar microtubules having nine doublet microtubules surrounding a central pair of single microtubules. (Fig.3.12) When zoospores produced by the species have only one swarming period, such zoospores are called **primary or monoplanetic** zoospores. (Fig3.13) Such zoospores after being released

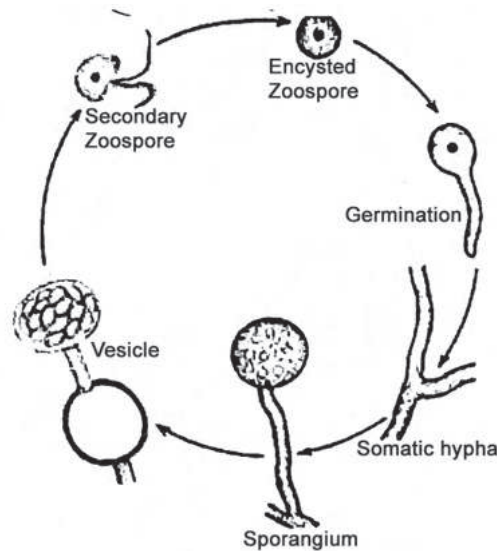

Fig. 3.14. Diplanetism in *Saprolegnia*.

from zoosporangium swim for a certain period of time and bind to suitable substratum after flagellar retraction where they directly germinate and give rise to new mycelia. Such behavioural pattern exhibited by a zoospore is known as **monoplanetism** (e.g. *Phythium*). Biflagellate zoospores produced by some species exhibit two periods of active movement separated by an encysted phase, such zoospores are called **diplanetic zoospores**. In *Saprolegnia*, the biflagellate primary zoospore comes out of the zoosporangium and begins to swim in the aquatic environment. After exhibiting a period of motility it retracts its flagella and comes to rest on a suitable substratum. Now it becomes covered by a thick wall to enter into the encystment phase. After a few hours, another biflagellate pear shaped zoospore comes out from the cyst which is called **secondary**

zoospore.(Fig.3.14) The latter, after being attached on the suitable substratum puts out a germ tube and develops a new mycelium. The behaviour of the zoospore of this kind is known as **diplanetism**. Repeated encystment and emergence stage of zoospore may occur in some species like *Dictyuchus* in their asexual cycle, such phenomenon is termed as polyplanetism and concerned zoospore is known as **Polyplanetic** zoospore.

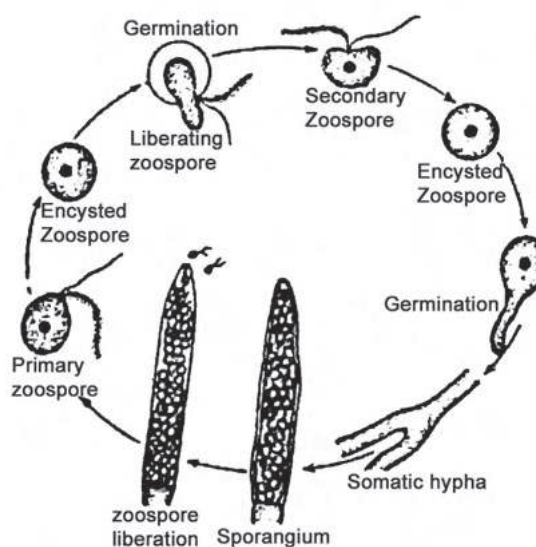

Fig. 3.13. Monoplanetism in *Pythium* sp.

- ii) **Conidia:** These are non motile exogenously developed spores usually found at the apex of a stalk like structure called conidiophores. The conidiophores may be branched (e.g. *Penicillium*) or they may be unbranched (e.g. *Aspergillus*). This type of spore is found in many different groups of fungi but especially in Ascomycotina and Deuteromycotina. The conidia develop from an initial cell called conidial initial. If no enlargement of conidial initial takes place during the development of conidia, such type of development is called **thallic** and the concerned conidia are called **thallospores** (e.g. *Endomyces geotrichum*). The term **blastic** is used to denote the development of conidia where the enlargement of the conidial initial that occurs during development. The conidia produced as a result of blastic development are called **blastospores or true conidia**. The thallospores may be of two types such as **arthrospores** and **chlamydo-spores**. Arthspores arise by close septation in basipetal succession. Each cell rounds off and sets free a thin walled arthrospore (eg. *Oidium*) (Fig. 3.15).



Fig. 3.15. Structure of arthrospore in fungi

Chlamydo spores are non deciduous, thick walled, dark brown coloured, unicellular endogenously originated spores. During their development the initiating terminal and intercalary cells round off and accumulate much reserve food materials. This kind of spore is found in *Fusarium*, *Mucor*, *Phytophthora* etc. (**Fig.3.16**)

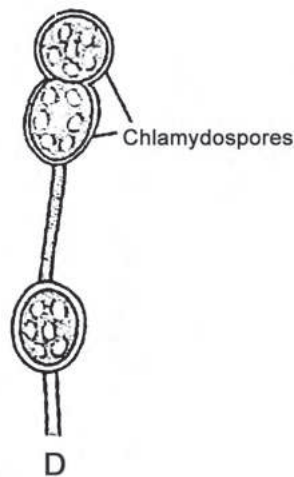

Fig. 3.16. Structure of Chlamydo spores

Blastic development of conidia is classified into two types such as **Holoblastic** and **Enteroblastic**. In holoblastic type both the outer and inner layers of conidiogenous cell contribute to the conidium formation (e.g. *Pleospora herbarum*, *Cladosporium herbarum*). In enteroblastic type only the inner wall

layer is involved in conidia formation. This development again may be of two types such as **tretic** and **phialidic**. In tretic type the inner wall of conidiogenous cell balloons out through a narrow pore present on its outer layer. As the conidiospore comes out through the pore, it is called **porospore** (e.g. *Alternaria*, *Curvularia*, *Helminthosporium*). In phialidic type, the conidiogenous cell itself is a specialised cell, called phialide. As the conidia are produced from such specialised bottle shaped cell i.e. phialide therefore these are called as **phialospores** (e.g. *Penicillium*) (Fig 3.17 A, B,C,D).

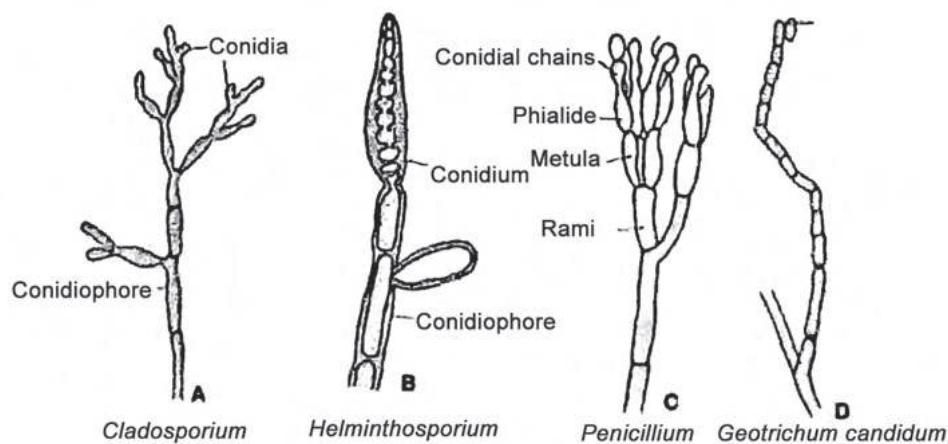

Fig. 3.17. Type of conidial development. A. Holoblastic; B. Enteroblastic Tretic; C. Enteroblastic Phialidic D. Thallic

3.3.3 Conidial fructification

Conidia bearing conidiophores and other vegetative hyphae of the fungus together constitute a well organized aggregated structure called conidial fructification. The conidiophores which are very much distinct, elongated developed as a discrete unit and distributed throughout the mycelium, are called as **mononematous**. If the conidiophores are so small that they are not be distinguishable from vegetative hyphae, such conidiophores are called **micronematous**. In many fungi distinct elongated conidiophores are aggregated together to form an organization called **macronematous** conidiophores. The following are the different type of compound structures formed as a result of conidial aggregation:

- a) **Synnema or coremium:** When the conidiophores become aggregated to form parallel fascicles of closely appressed hyphae, such aggregates of conidiophores

are termed as synnema. Example –*Doratomyces*, *Graphium*, *Podosporium* etc.

- b) **Sporodochium** : Sporodochium is a crust or disc or cushion shaped structure in which loose mass of conidiophores arises from a mass of aggregated hyphae or stroma. Conidiophores in this structure usually touch each other and may even overlap. Example – *Tubercularia vulgaris*, *Epicoccum purpurascens*.
- c) **Acervulus**: It is a pseudoparenchymatous aggregate of hyphae that often develop beneath the host epidermal surface from which very small, superficial, open, flat bed of closely packed conidiophores bearing conidia are formed. Though the conidiophores appear much closer to each other but in reality they do not touch each other. In some acervuli dark sterile hair like structures are found which are called setae. This type of asexual fruit body is found in *Colletotrichum graminicola*.
- d) **Pycnidium** : These are flask shaped or globose hollow fructifications growing superficially or remaining immersed in the host tissue. The inner wall layer of the pycnidium is lined with a layer of conidiogenous cells of various types from which conidiophores bearing conidia develop. The whole structure opens to the exterior by a pore called **ostiole**. The conidia that develop in pycnidia are called as **pycnidiospores**. Several pycnidial cavities remain enclosed in a single fructification to form a structure called **pycnidial stroma**. Pycnidia are found in *Phoma*, *Ascochyta*, *Septoria* etc. **(Fig.3.18 A,B,C,D)**

3.3.4 Asexual spores related to sexual reproduction

In Ascomycetes and Basidiomycetes, spores are produced as a result of sexual reproduction. Such spores are ascospores and basidiospores respectively.

3.3.4.1 Ascospores are different shape and size. These are produced inside a club shaped structure called ascus. Usually the ascospores are globose to oval or elliptical in shape, usually eight in number per ascus. *Neurospora tetrasperma* is somewhat unusual in that it has four spored asci and the ascospores are binucleate. The walls surrounding the protoplast of ascospores are multilayered. The innermost layer is the endosporium, outside which is the episporium. The ribbed layer outside the episporium is known as **perisporium**. External to this layer smooth surface layer is present. **(Fig 3.19)** The ascospores bearing asci are arranged in a layer to form a structure called **hymenium**. The hymenium layer is

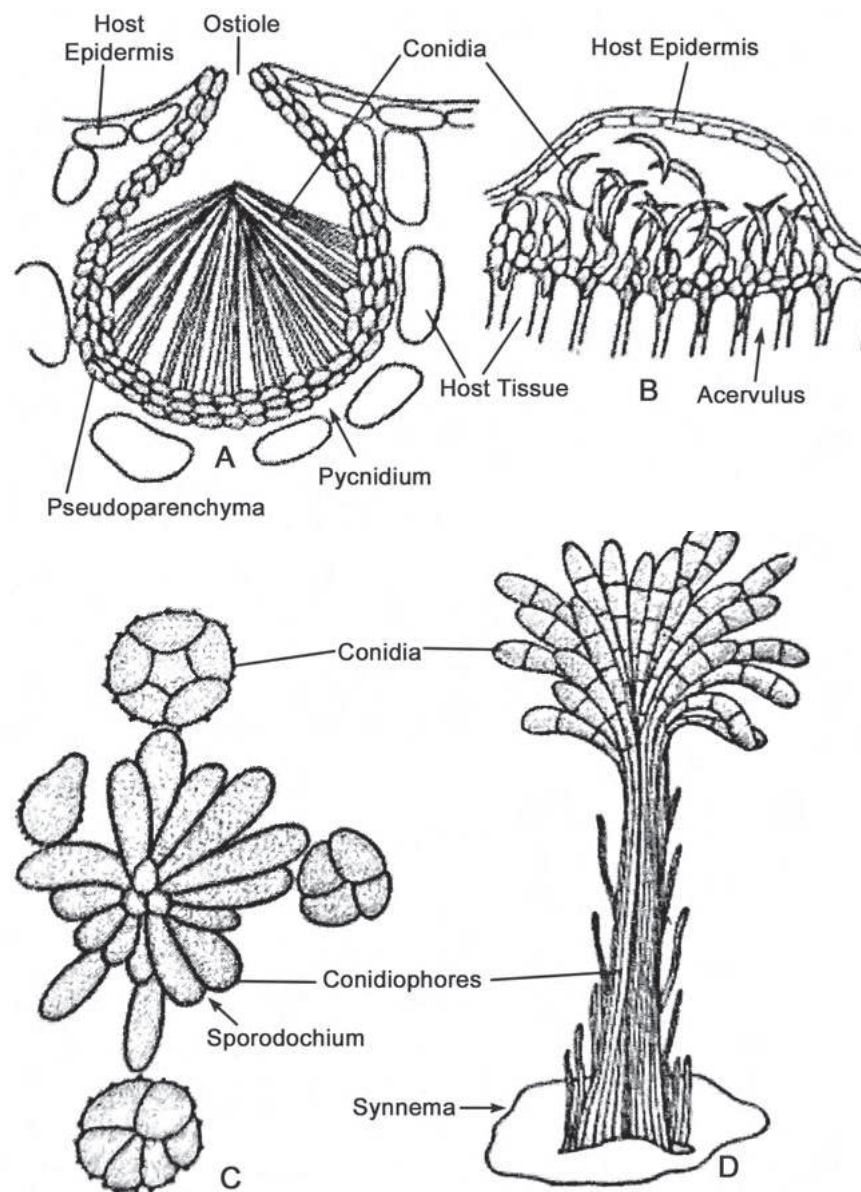

Fig. 3.18. Asexual reproduction and arrangement of conidiophores : A. pycnidium with conidia in *Septoria*, B. Acervulus with conidia in *Marssonina*, C. Sporodochium of conidiophores and conidia in *Epicoccum*; D. Synnema of conidiophores and conidia in *Arthrobotrys*.

closely associated with other sterile hyphae to form a compact well organized structure called sexual fructification. In Ascomycotina three types of morphologically distinguishable fruit bodies or fructifications are found, such as: **a) Apothecium** : It is a cup or saucer shaped fruit body found in *Ascobolus*, where the hymenium is exposed on the upper side.

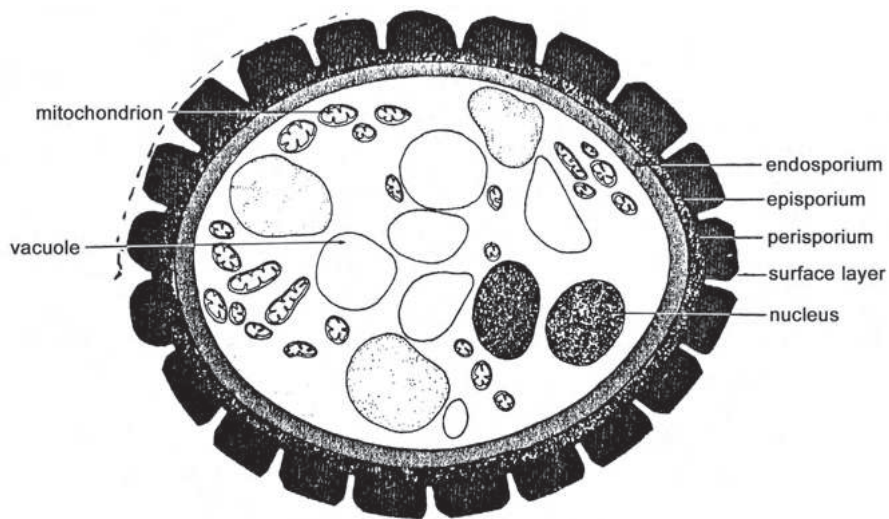

Fig. 3.19. *Neurospora tetrasperma*. T. S. ascospore, Simplified diagram based on an electron micrograph by Lowry in Sussman & Halvorson (1966).

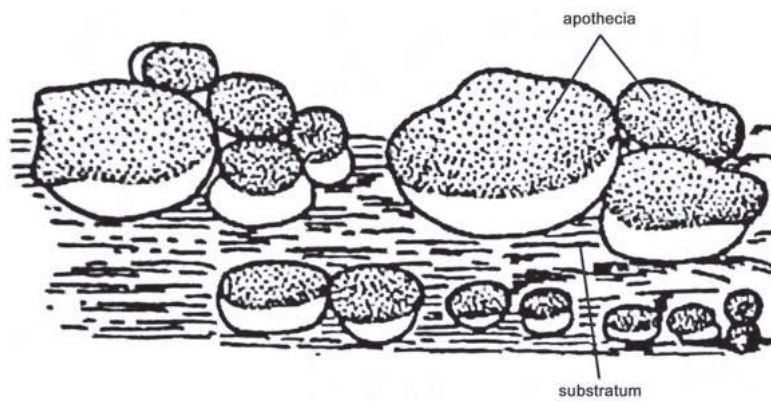

Fig. 3.20(a). *Ascobolus* : Aerial apothecia.

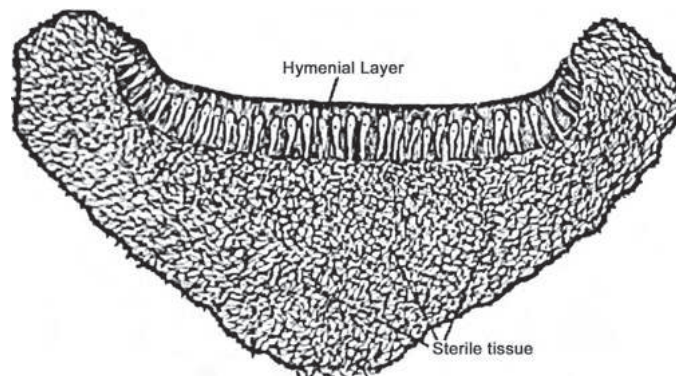

Fig. 3.20(b). *Ascobolus* sp. Diagram of apothecium in section showing hymenial layer and sterile tissue.

The lower region of the fruit body which is made up of vegetative sterile mycelia is known as **excipulum**. The ascospore bearing asci remain intermingled with sterile paraphysis. **(Fig 3.20 a&b) b) Cleistothecium** : In this type of fruit body asci are developed endogenously within a spherical structure produced by compactly arranged vegetative hyphae. Example – *Penicillium*. **(Fig 3.21) c) Perithecium** : It is a flask shaped fruit body which opens to the exterior by an opening called ostiole. The fruit body is internally lined with a layer of asci which remain intermingled with sterile vegetative hyphae called paraphyses. Example -*Claviceps* **(Fig 3.22)**.

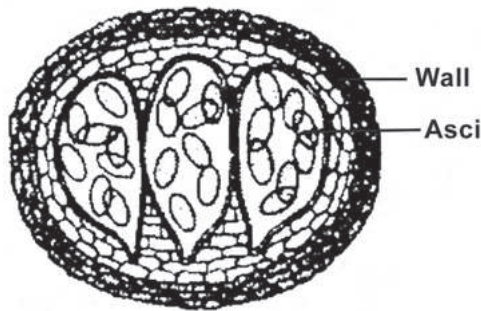

Fig. 3.21. Cleistothecium

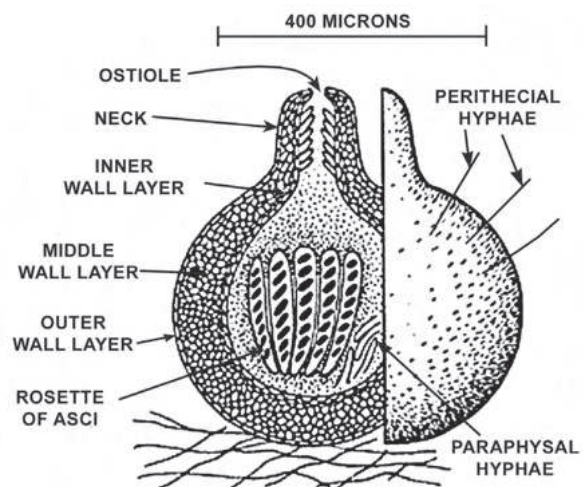

Fig. 3.22. Structure of a perithecium

Two different types of sex organ is produced during sexual reproduction in Ascomycotina, the male sex organ is known as antheridium and the female sex organ is known as **ascogonium** which contain male and female gametes respectively. Both the sex organs are connected with the help of a tubular connection called **trichogyne** through which male nuclei migrate into ascogonium. Inside the ascogonium nuclear pairs are formed. From the periphery of ascogonium many hyphae develop which are called **ascogenous hyphae** within which the paired nuclei migrate. So ascogenous hyphae are dikaryotic in nature. The cells of such hyphae serve as **ascus mother cells**, from which ascospore bearing asci are produced. **(Fig 3.23)**

3.3.4.2 Basidiospores are produced in the members of Basidiomycotina. The spores are unicellular; their shape may vary from globose, sausage shaped, fusoid etc. Their surface may remain smooth or highly ornamented. The colour of the basidiospore may vary greatly. Basidiospores are exogenously produced on a club shaped structure called basidium. On the basidium the basidiospores either remains attached directly (e.g. *Cyathus*) or they

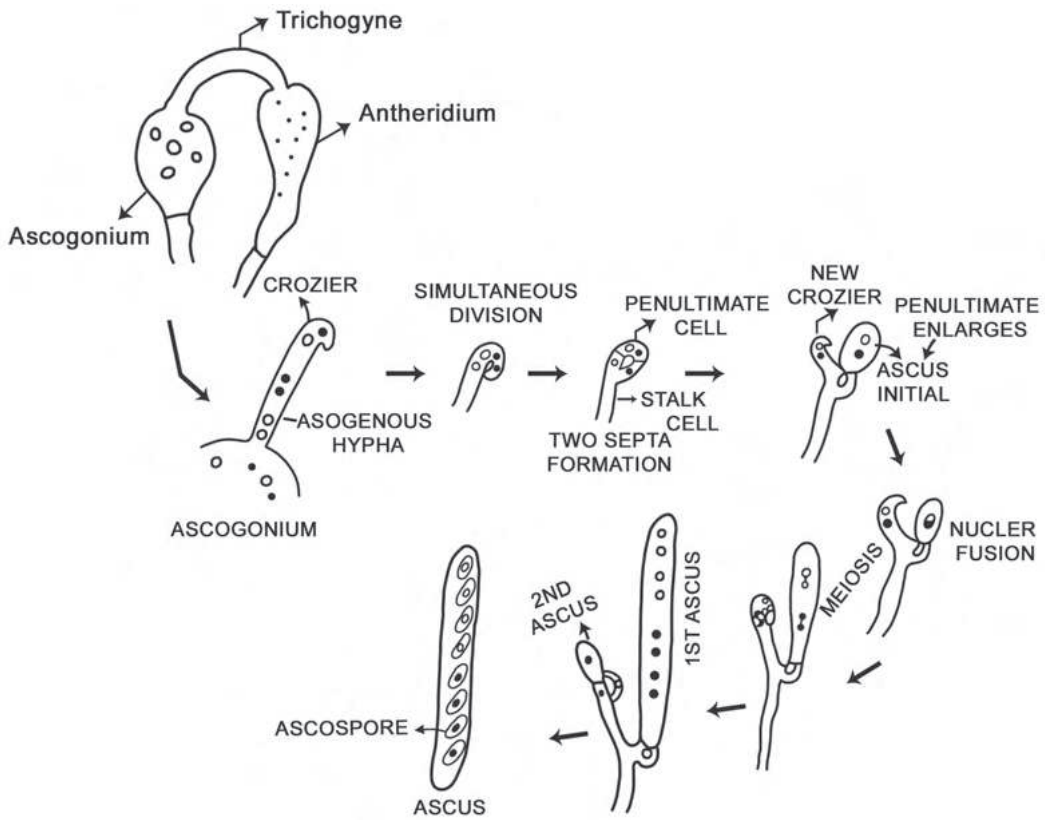

Fig. 3.23. Steps of the development of ascospores bearing asci in Ascomycetes.

remain attached to a spine like projection developed on the apex of the basidium called **sterigma.**(**Fig.3.24**) Usually four basidiospores remain attached with the basidium except *Phallus impudicus* where there may be nine spores per basidium. The point at which the

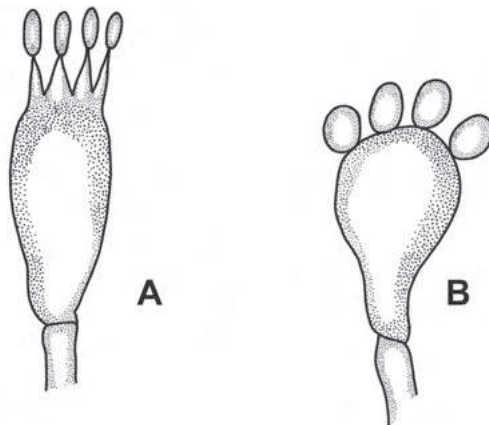

Fig. 3.24. A&B : A. Sterigmatic basidium (e.g. *Agaricus*), B. Asterigmatic basidium (e.g. *Cyathus*)

spore is attached to the sterigma is called as **hilum**. The latter is found at the tip of a short conical projection called hilar appendix. The term **balistospore** is used to describe basidiospores which are violently projected from sterigma. Like ascospores, the basidiospores also remain surrounded by multilayered wall, from inside to outward the layers are **endosporium, episporium, exosporium, perisporium, and ectosporium.** (Fig 3.25) In some species of *Coprinus* the perisporium forms a loosely attached layer which surrounds the spore as a loose envelope called as the **perisporial sac**. When the basidium is

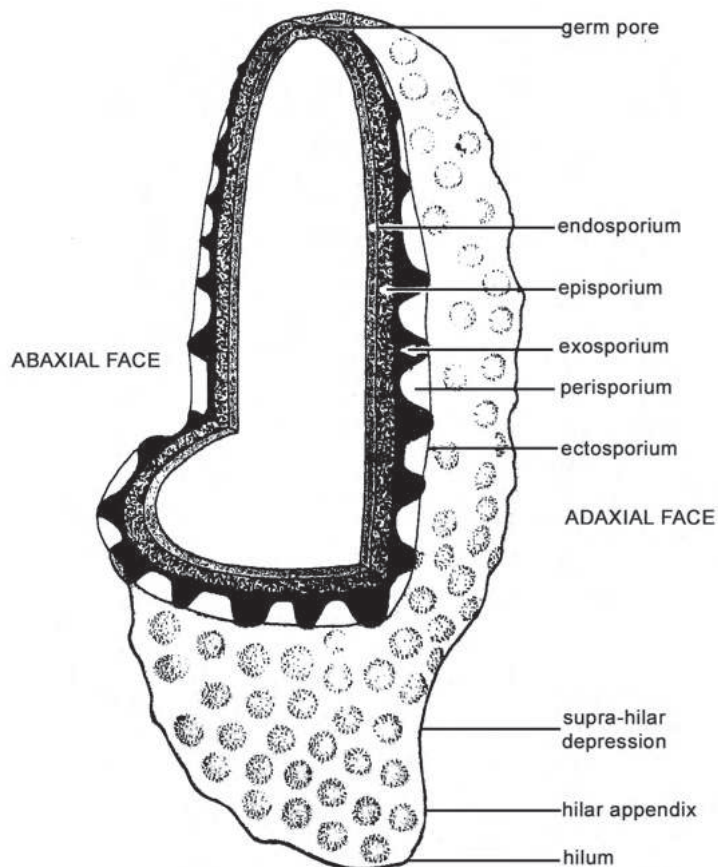

Fig. 3.25. Basidiospore structure. Diagram of cut-away view to illustrate terminology of the layers of the spore wall, based on Pegler & Young (1971). The contents of the spore are not shown.

aseptate, it is called **holobasidium** (e.g. *Agaricus*) and when it is septate either transversely or longitudinally, such basidium is called **phragmobasidium** (e.g. members of Uredinales and Ustilaginales). In the members of Dacrymycetaceae the tip of the basidium is prolonged into two long arms, such basidium is known as **tuning fork type** (fig 3.26). The

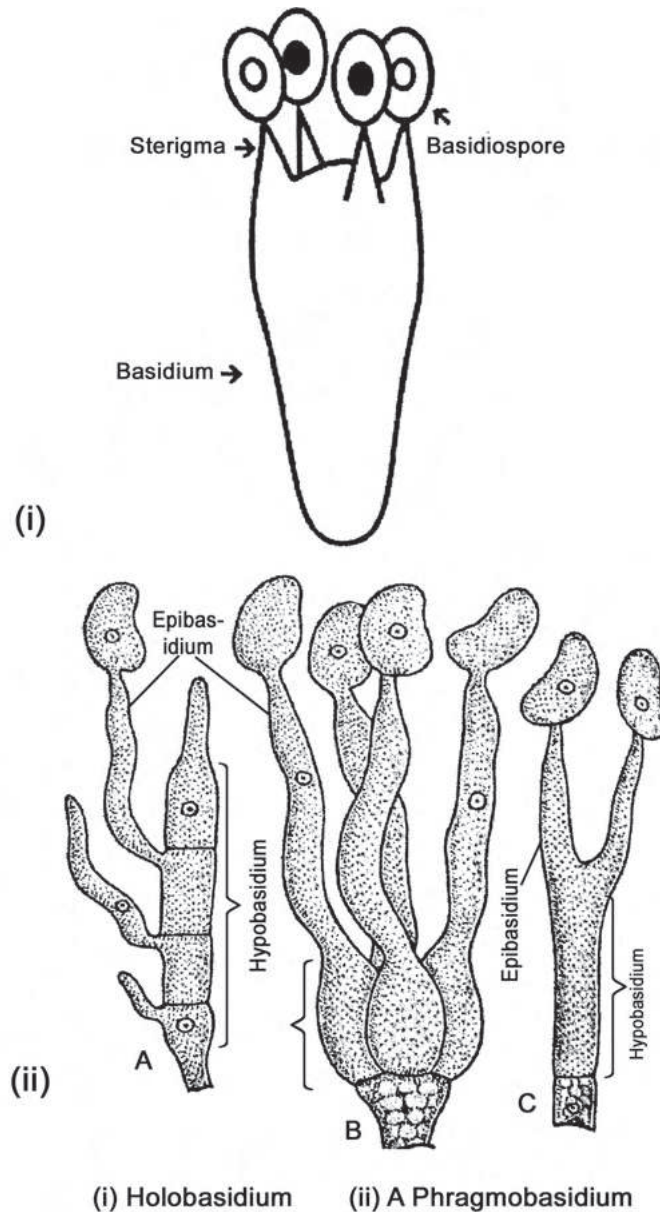

Fig. 3.26. Different types of basidia in Basidiomycetes : (i) Holobasidium (ii) Phragmobasidium (A), (ii) Tuning fork type basidium (B & C).

developmental precursor of basidium which is produced as a projection from secondary mycelium in which diploid nucleus is present is described as **probasidium**. The probasidium stage enters into next developmental stage called **metabasidium** in which the diploid nucleus of probasidium undergoes meiosis (**Fig 3.27**).

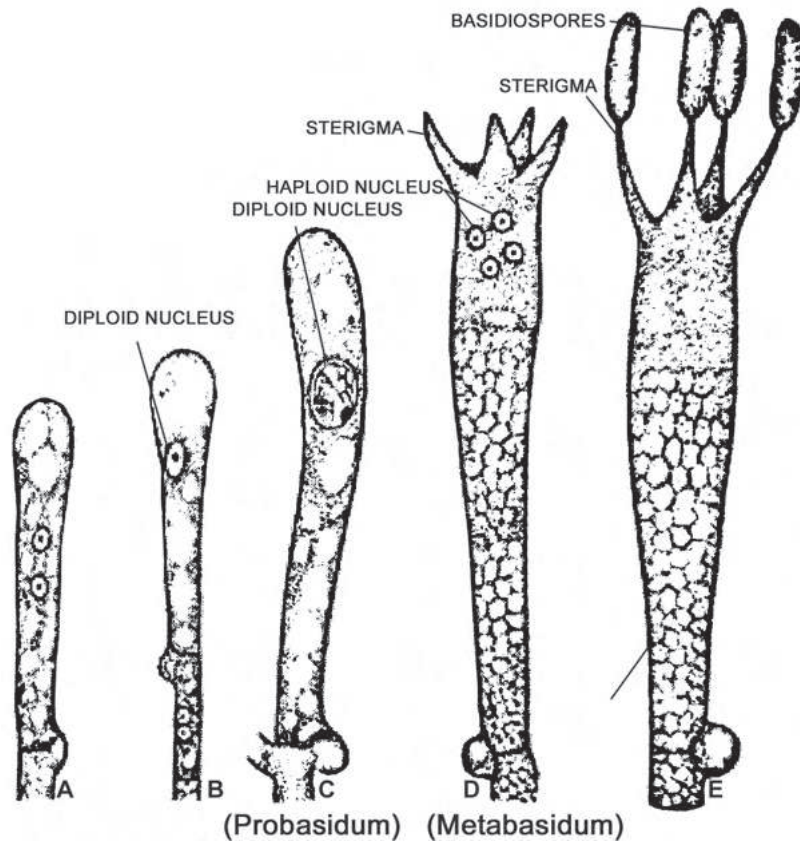

Fig. 3.27. Successive stages in the development of a basidium and basidiospores. A. Dikaryotic terminal cell. B–C. Karyogamy, D. Young basidium with four haploid nuclei and four sterigmata. E. Mature basidium with four basidiospores borne on sterigmata.

3.3.5 Sexual reproduction in fungi

There are three distinct phases in sexual reproduction of fungi, such as plasmogamy, karyogamy and meiosis. These three phases occur in regular sequence and usually at specific point in the life cycle. **Plasmogamy** involves union of two protoplasts bringing the nuclei of opposite strains close together within same cell. When the vegetative cell of the mycelium is unicellular, the plasmogamy between two mycelia of opposite sexuality results in the formation of a cell with two genetically distinct nuclei. Such process is described as **dikaryotization**. **Karyogamy** is a process in which two opposite nuclei which are brought together by plasmogamy are fused. The process of karyogamy leads to the formation of diploid nucleus in a cell and the process therefore is called as **diploidization**. Diploid nucleus produced after the nuclear fusion sooner or later undergoes **haploidization** following

the process called **meiosis**. The different methods of sexual reproduction in fungi are as follows:

- a) **Planogametic copulation:** It involves fusion of two gametes both of which may be motile or one of them is motile and the other is non motile. This type of sexual reproduction is found in the members of Mastigomycotina. There are three type of planogametic copulation such as: **isogamous**, **anisogamous** and **heterogamous**. In isogamous type both the copulating gametes are of identical size and morphology (e.g. *Synchytrium*). In anisogamous copulation though the gametes are morphologically identical but their sizes are different. Usually the male gametes are smaller and female gametes are larger in size in case of heterogamous copulation (e.g. *Allomyces*).The female gamete is large and nonmotile and the male is smaller and motile. The male gamete enters the oogonium and fertilizes the egg to produce oospore (*Monoblepharis*).**(Fig 3.28)**

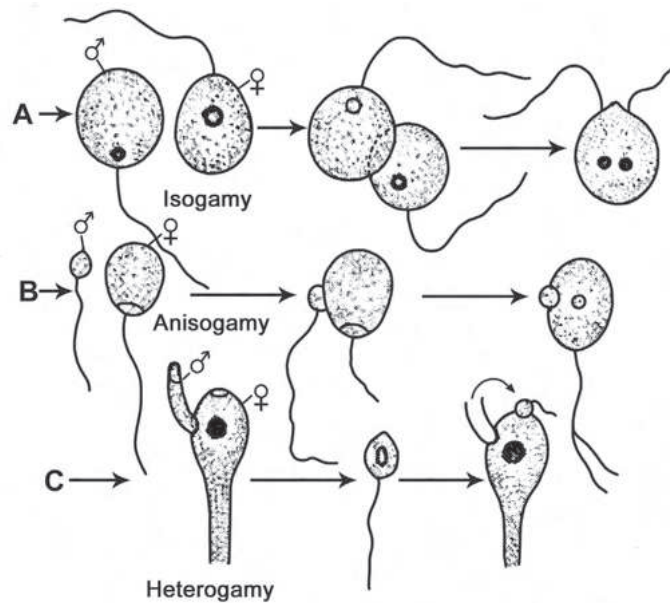

Fig. 3.28. Sexual reproduction in fungi : A, isogamy – as seen in *Synchytrium*; B, anisogamy – as seen in - *Allomyces*, C, Heterogamy – as seen in *Monoblepharis*.

- b) **Gametangial contact:** In this process two gametangia distinguished as male and female are involved in the process of sexual union. The antheridium contains many male nuclei which are never released from the antheridium but are freed into the oogonium developed in between the point of contact through a pore. Though many male nuclei migrate into the oogonium but only one of them fuses

with the only female nucleus present within it. The product of sexual union is oospore. The antheridium is said to be **amphigynous** when it encircles the oogonial stalk, a condition brought on by the growth of the oogonial initial through the antheridial initial (e.g. *Phytophthora infestans*). The antheridium is called **paragynous** when it attaches laterally on the oogonial wall, developed from same or different hyphae (e.g. *P.cactorum*). (Fig 3.29)

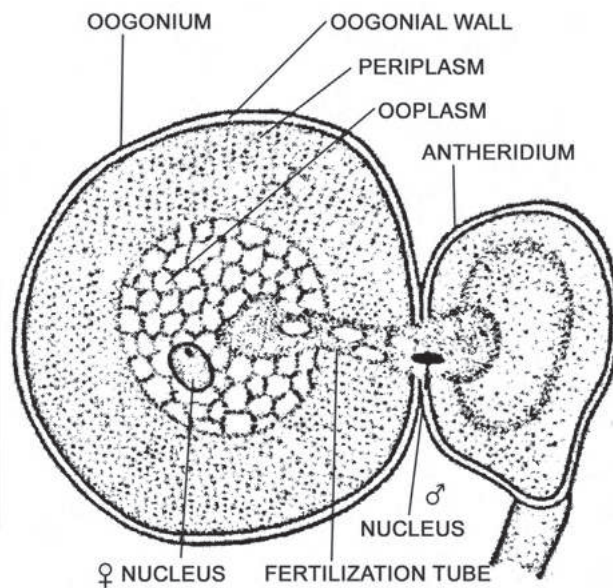

Fig. 3.29. Sexual reproduction : Gametangial contact by means of fertilization tube in *Pythium aphanidermatum*.

- c) **Gametangial copulation:** This is the fusion of the entire contents of the two contacting gametangia. Such fusion occurs in two ways, such as: In **hologamous copulation** where the entire male thallus acts as gametangium which attaches itself to female thallus and empties its entire contents into it through a pore developed at the point of contact between the two gametangia (*Polyphogus sp.*). Another mode of copulation is **direct fusion**, in which two gametangial cells fuse directly to result into one. The protoplast of the two gametangia mix in a common cell produced as a result of dissolution of the contacting wall (e.g. *Rhizopus, Mucor, Dipodascus*). (Fig 3.30)
- d) **Spermatization :** In some fungi spore like male reproductive units are produced which are called **spermatia**. Spermatia are carried by air current, insects or water and lodged on a special receptive hyphae or female reproductive organ

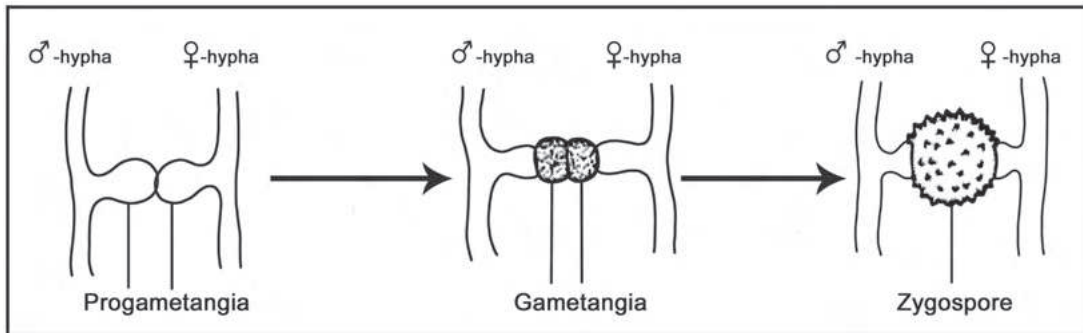

Fig. 3.30. Process of Gametangial Copulation leading to the production of zygospore.

or even to the somatic hyphae. A pore developed at the point of contact and the content of the spermatium is released into the female organ. Examples: *Puccinia graminis*, *Podospora*. (**Fig 3.31**)

- e) **Somatogamy:** In higher fungi such as Ascomycotina and Basidiomycotina sex organ formation does not take place, instead, two somatic hyphae of opposite sexuality fuse to bring together the compatible nuclei. This process is also known as **pseudomixis**. Pseudomictic copulation between a mother and daughter cell is known as **adelphogamy**. When a matured and immature cell is fused with each other the process is called **pedogamy**. In fungi from lower to higher group a gradual simplification of the reproductive structure is observed. Though sexual differentiation is lacking, in higher fungi the copulating mycelia retain their polarity. Thus simplification of sex organs with retention of polarity is known as **degeneration of sex**. (**Fig 3.32**)

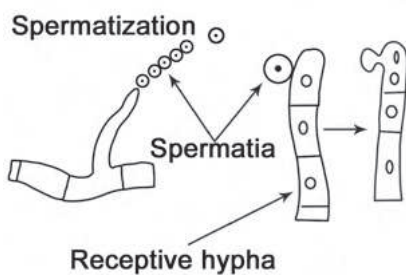

Fig. 3.31. Spermatization

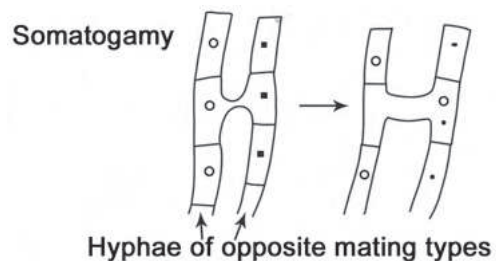

Fig. 3.32. Somatogamy

Sexual reproduction in many fungi does not require the interaction of different thalli that means every thallus is sexually self-fertile and self compatible. Such fungi are called **homothallic** fungi. In others, the thallus is not self compatible and requires a compatible

thallus to exhibit sexual reproduction. Such fungi are called heterothallic fungi. The heterothallic fungi sometimes could be distinguished morphologically in respect of the structure of their sex organ; such heterothallism is called **morphological heterothallism**. In others, the heterothallism is governed by genetic factors. When the sexual compatibility is governed by a single factor and its two alleles such heterothallism is called as **bipolar** heterothallism. The heterothallism is described as **tetrapolar** or bifactorial when two factors with its four alleles are involved as a determinant of heterothallism. In a similar way the heterothallism may be **octapolar** where four factors with eight alleles are involved.

Some fungi do not go through a true sexual cycle yet derive the benefits of sexual reproduction by a process called **parasexuality**. In this process plasmogamy, karyogamy and meiosis take place but not at specified points in the life cycle. In parasexual cycle, recombination occurs during the mitosis instead of meiotic cycle. This phenomenon was discovered by Pontecorvo and Roper (1952) in the fungus *Aspergillus nidulans*.

3.3.6 Sexual spores

The sexual spores in fungi are zygospores and oospores. Zygospores are produced by the members of Zygomycetes e.g. Mucorales. Zygospores are often large, thick walled, warty structure with large food reserves and are unsuitable for long distance dispersal. Oospores are produced as a result of gametangial copulation or markedly unequal gametic fusion. It is the characteristic of sexually produced spores of the Oomycetes. Oospores are produced from fertilized oosphere, or sometimes parthenogenetically.

3.4 □ Life cycle of *Penicillium*

Penicillium belongs to the class Ascomycetes. It is commonly known as green mould or blue moulds because it forms characteristic blue green colouration due to its colonial growth on the substrates like fruits, decaying vegetables etc. The genus has about 100 species and it is very commonly distributed. Though most of the species are saprophytic but *P. expansum* and few others are weak parasites causing rotting and spoilage of fresh fruits in storage. Some species are of great industrial value. *Penicillium roqueforti* and *P. camemberti* is used in hydrolysis of fats and to impart characteristic flavour to cheese. Some species are used as a source of medicine. The antibiotic penicillin was obtained from the species like *P. notatum*, *P. chrysogenum* etc. Important antifungal antibiotic griseofulvin is obtained from *P. griseofulvum*.

3.4.1 Vegetative structure

The vegetative body is made up of mycelium which is profusely branched and septate. The hyphae may grow deeply inside the substratum or may grow superficially and form mycelial felt. The cells of vegetative hyphae are thin walled, uni or multinucleate. The colonies appear as floccose, velvety or funiculose. The hyphae are usually coloured due to the presence of pigments on the surface of the cell wall. The cytoplasm is granulated and vacuolated and contains cell organelles like mitochondria, ER, ribosomes and globular type of reserve food materials. The vegetative mycelia often aggregated to form compact structure called sclerotium (**Fig. 3.33**).

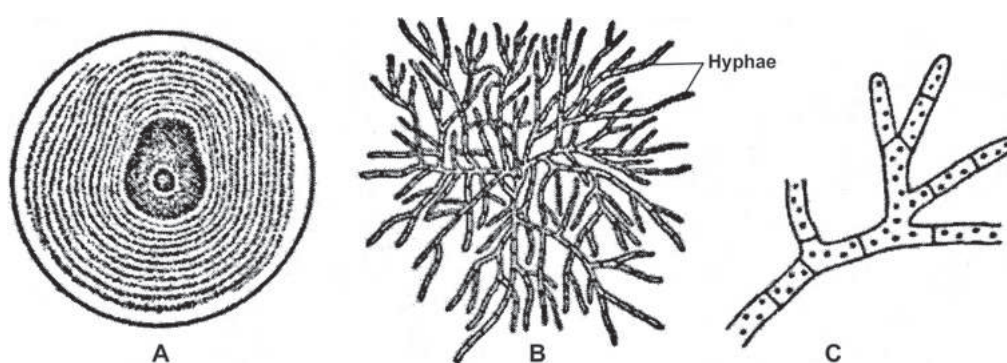

Fig. 3.33. *Penicillium* :A. A colony, B. Mycelium of *Penicillium*, C. Mycelium, (enlarged view).

3.4.2 Reproduction

Penicillium reproduces vegetatively, asexually and sexually. Vegetative reproduction takes place by fragmentation. The vegetative mycelia are segmented into small pieces; each segment grows into a new vegetative mycelium.

3.4.2.1 Asexual reproduction:

Asexual reproduction takes place by conidia formation. Conidia are produced on a specialised branched stalk called as conidiophores. The name *Penicillium* has been derived from Greek word penicilli which means a brush. The conidiophores with conidia give the appearance of a broom or brush for which the genus is so named. The conidiophore emerges as an erect branch which divides dichotomously at the apex and forms first whorl of branches called **rami** (Singular: ramus). Rami in turn divide dichotomously to form another whorl of branches called **metulae**. Metulae are terminated by many bottle shaped

uninucleate structures called **phialides**. On the phialides conidia are produced in a basipetalous chain. The conidia are green and dry and dispersed by wind. In *P. claviforme* the individual conidiophores may be aggregated together into a club shaped fructification called **coremia** (Fig 3.34).

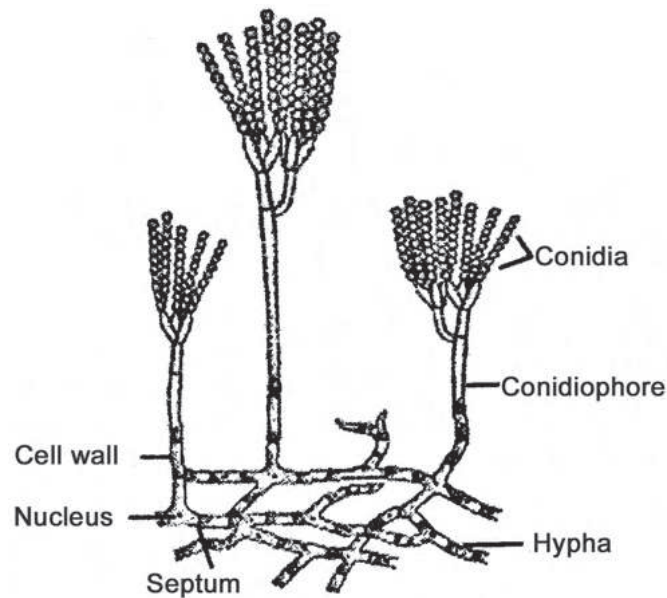

Fig. 3.34 (a). *Penicillium* spp. Mycelium showing hyphae and conidiophores bearing conidia.

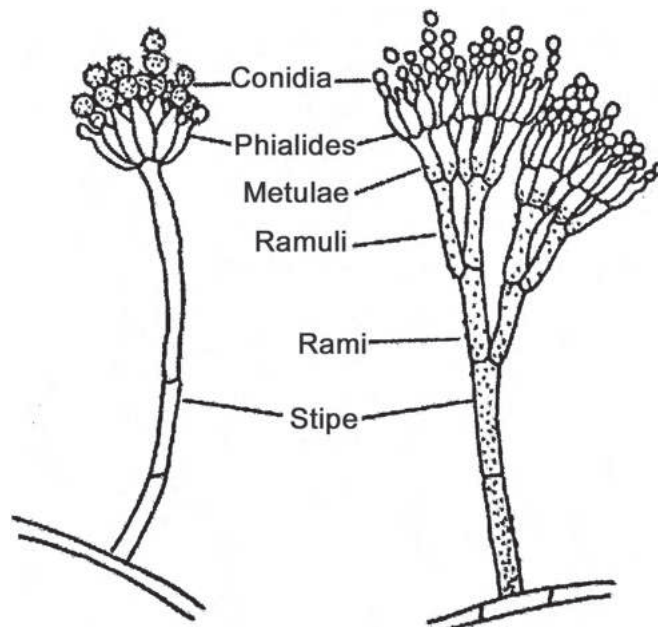

Fig. 3.34 (b). Different order of branches in Conidiophore of *Penicillium*.

3.4.2.2 Sexual reproduction:

Most species of *Penicillium* is homothallic except some like *P.luteum* is heterothallic. The sexual reproduction is basically of gametangial contact type. Two distinct sex organ formations occur during sexual processes; the male sex organ is called antheridium and the female sex organ is called ascogonium. The latter is multinucleate usually elongated erect structure. The antheridia formation though observed in most species but they are functionless. The sexual reproduction has been studied well in *P.vermiculatum*. In this species, the ascogonium is formed as an erect multinucleate branch adjacent to which from the same hypha antheridial branch is produced which coils around the ascogonial branch. A septum is developed at the tip of the slender antheridial branch which forms the antheridium proper. The antheridium comes in contact with the ascogonial wall, at the point of the contact, the contact wall is dissolved but no nuclear migration from the antheridium to ascogonium is reported. The multinucleate ascogonium undergoes septation to form a row of bi nucleate cells. Each bi nucleate cell grows into an elongated branched ascogenous hypha. Simultaneously with the development of ascogenous hyphae, sterile elongated vegetative hyphae grow up around the sex organs from the adjacent hyphal cells. Such sterile hyphae by their compact growth around the sex organs form a globose two layered ascocarp called **cleistothecium**. (**Fig 3.35 a**) The cleistothecium is usually yellowish in colour. Within the ascocarp asci are formed which are globose or pear shaped. Each ascus bears eight haploid ascospores. Though the details of the development of asci from ascogenous hyphae are unknown but nuclear fusion or karyogamy followed by meiosis occurs in ascus mother cells leading to the development of eight spored ascus. Matured

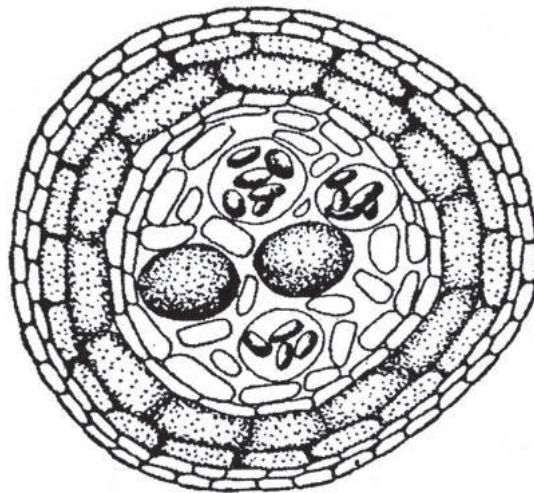

Fig. 3.35 (a) : Cleistothecium

asci are irregularly distributed within the cleistothecium. The ascospores are set free from asci by the disintegration of the wall of asci. The free ascospores lie within the ascocarp and the same are released outside by the degeneration of the wall of ascocarp [Fig 3.35(b)].

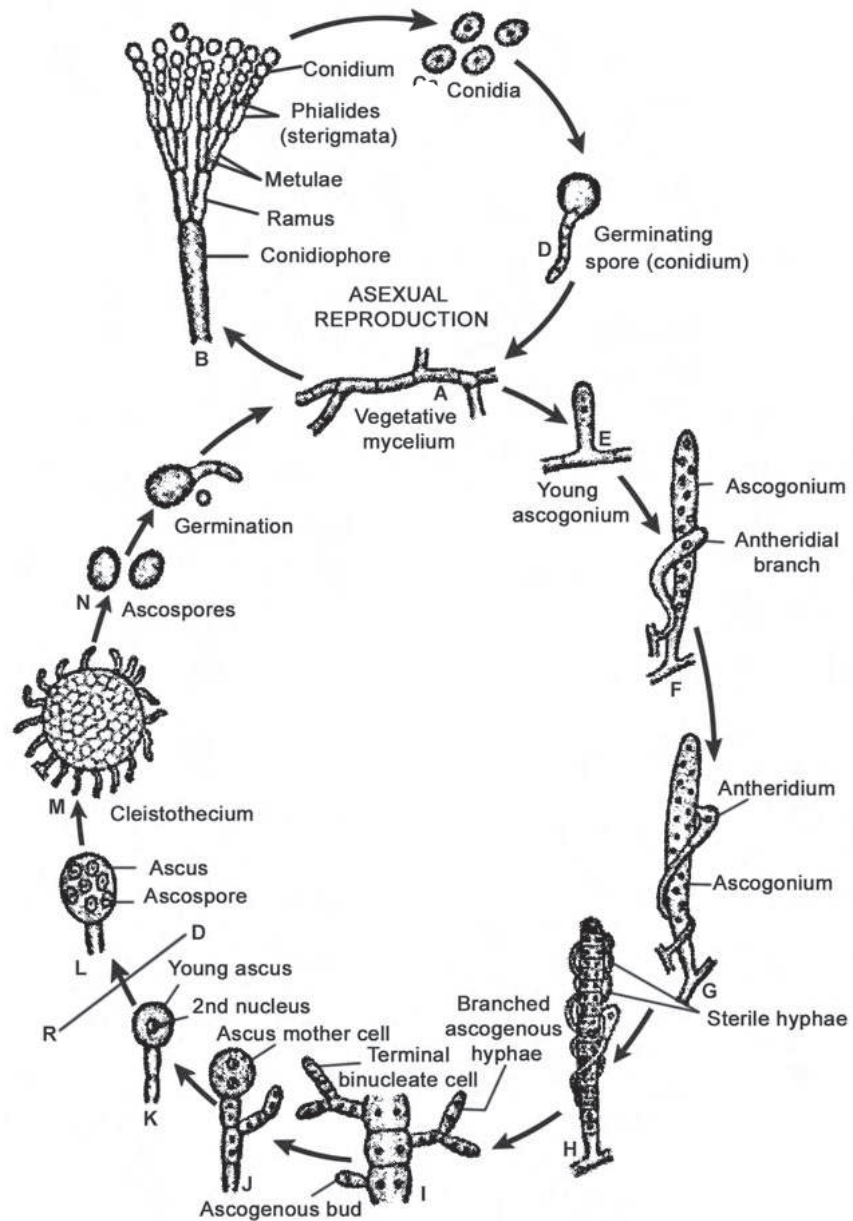

Fig. 3.35 (b). Life cycle of *Penicillium*

3.3.2.3 Systematic position (Ainsworth ,1973):

Kingdom : Mycota

Division : Eumycota

Subdivision : Ascomycotina

Class: Plectomycetes

Order ; Aspergillales

Family : Aspergillaceae

Genus : *Penicillium*

3.5 □ Life cycle of *Agaricus*

Agaricus is a saprophytic fungus belonging to the class Basidiomycetes. It commonly grows on straw heaps, manure heaps, and horse dung and other decomposed matter. Many species are cultivated as edible mushroom such as *Agaricus campestris*, *A. bisporous*, *A. rodamani* etc. Many species of this genus are highly toxic such as *A. sylvaticus*, *A. placomyces*, *A. xanthodermus* etc.

3.5.1 Vegetative body

The vegetative body is made up of septate much branched hyphae. Basidiospore germinates to produce primary monokaryotic mycelium. The primary mycelium undergoes somatogamy to produce diploid secondary mycelium. The hyphae of such secondary mycelium intertwine together and form a compact mass called rhizomorph. Another type of mycelia are found which play role in the construction of basidiocarp, such mycelia are called tertiary mycelia. The subterranean secondary mycelium grows from a central point and form a circular area of mycelial growth. At the periphery

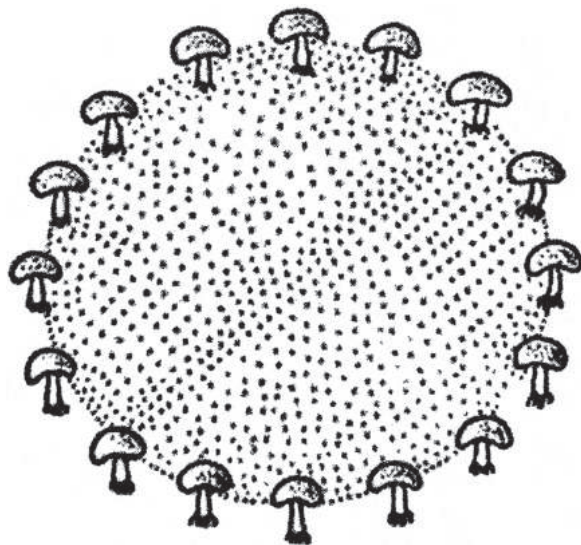

Fig. 3.36. *Agaricus* : Fairy rings

of such circular mycelial region, the fruit bodies or basidiocarps are formed. It is imagined that such circular ring formed by the growth of basidiocarp represents the path of dancing fairies and therefore it is called fairy ring. (**Fig 3.36**)

3.5.2 Reproduction

Agaricus reproduces by vegetative, asexual and sexual method.

3.5.2.1 Vegetative reproduction:

The diploid vegetative mycelia grow inside the suitable substratum and form a mycelial chunk called spawn. This spawn is considered as seed for the production of fruit body. Spawn are allowed to grow inside the soil supplemented with suitable organic matters to develop into fruit bodies.

3.5.2.2 Asexual reproduction:

Under unfavourable condition the dikaryotic mycelia produce terminal or intercalary thick walled dormant spore called chlamydospore. It germinates during favourable condition and forms dikaryotic mycelium.

3.5.2.3 Sexual reproduction:

Sex organ formation does not occur during sexual reproduction of *Agaricus*. Two vegetative hyphae of opposite polarity fuse with each other by the process called somatogamy and produce dikaryotic mycelium. The entire process of somatogamy involves three steps such as plasmogamy, karyogamy and meiosis. In plasmogamy, the cytoplasm along with nuclei of two vegetative cells of two compatible hyphae is mixed to produce a dikaryotic mycelium. Next, the two compatible nuclei of each dikaryotic cell are fused to form diploid cell and the mycelium of diploid nature thus produced is called secondary or diploid mycelium. Meiosis occurs inside the basidium soon after karyogamy and forms four haploid nuclei which are differentiated into four basidiospores. The latter develop at the apex of sterigma.

3.5.2.4 Development of basidiocarp:

The underground secondary mycelia form white coloured hypahal knots which are pseudoparenchymatous in nature. Such hypal knots develops into button stage. During development, the button differentiates into an apical hemispherical region and a basal cylindrical solid stalk. The former is called pileus and the latter is called stipe. Towards the base of the hemispherical region, some hyphae are drawn apart and form a ring like cavity

called prelamellar chamber. At the upper surface of chamber there are alternating bands of slow and rapidly dividing cells. The latter serve as gill primordia which by further growth form downwardly hanging radiating membranous structure called gill. Due to gradual expansion of pileus, interspaces are formed between the gills. The margin of the pileus remains attached with the stipe by a tissue called velum which is distorted due to expansion of pileus and leaves a ring like membranous scar on the stipe called annular ring.

3.5.2.5 Structure of Basidiocarp :

The matured basidiocarp is umbrella shaped, differentiated into two parts, lower stalk like part or stipe and expanded convex region i.e. pileus (5-12 cm in diameter). (Fig 3.37)

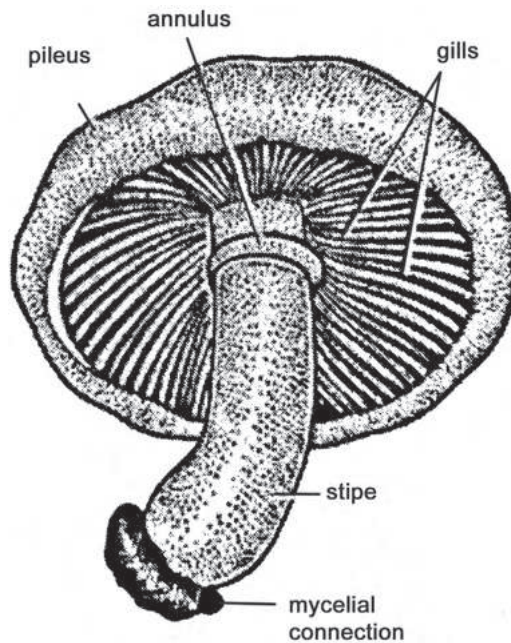

Fig. 3.37. *Agaricus* : A mature basidiocarp

Pileus : The colour of the pileus may be light brown or sometimes creamy white. The surface is smooth and dry. On the lower surface of the pileus there are many radiating membranous structures which hang downward called gills. Gills are pink in colour when immature but converted into dark brown colour on maturity. On both this surfaces of the gill, fertile layer or hymenium is present. The VLS of the gill shows the following tissue regions:

- a) **Trama:** It is the central region of the gill and made up of numerous loosely arranged interwoven hyphae running from the pileus.

- b) **Sub hymenium:** On both sides of trama this layer is present. It is made up of hyphae develop laterally from trama. The cells are more or less isodiametric.
- c) **Hymenium:** This is the fertile region of the basidiocarp made up of club shaped basidia and sterile paraphyses. The diploid cell of the secondary mycelium protrudes as a club shaped outgrowth in the hymenium region. This is the probasidium which contains diploid nucleus within. The diploid nucleus undergoes meiosis and form four haploid nuclei, two of + and two of – strain. Four spine

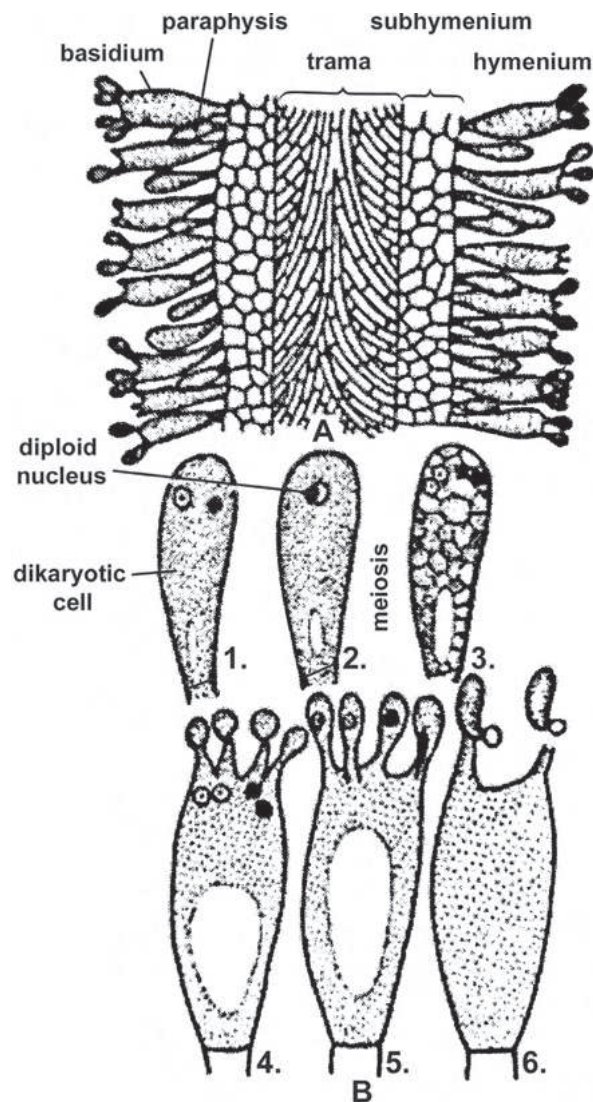

Fig. 3.38. *Agaricus* : Structure of gill, (A) Vertical section of gill, (B₁₋₅). Various stages in the development of basidium, (B₆) Release of basidiospore from basidium.

like projections develop at the apex of the basidium through each of which one haploid daughter nucleus migrates and differentiates into basidiospore. Such spine like structure is called sterigma. Thus, four basidiospores differentiate exogenously on each basidium. The wall of basidiospore is made up of chitosan, chitin and β glucan. (Fig. 3.38)

Dispersal of basidiospores: On maturity, the basidiospores are released from sterigma by a mechanism called water droplet mechanism. During release of spore a water droplet appears at the hilar appendage which gradually enlarges and creates pressure on the basidiospore. Such pressure helps in the detachment of basidiospore from the sterigmata.

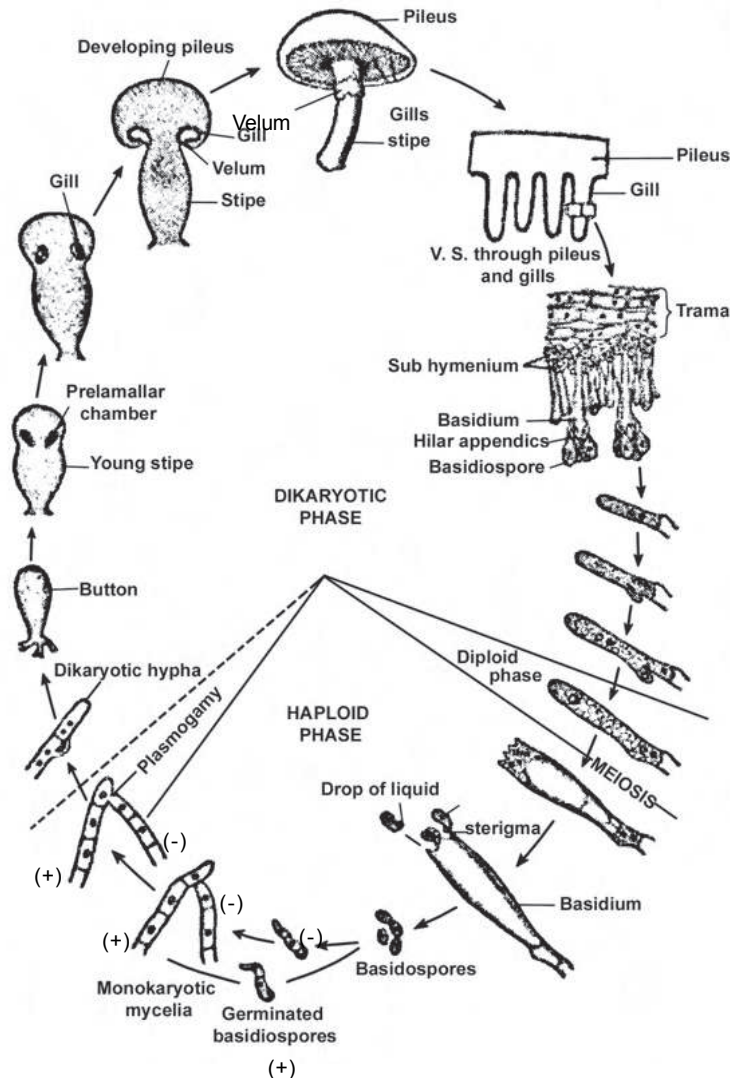

Fig. 3.39. Life cycle of *Agaricus*.

Germination of basidiospores : After falling on suitable substratum basidiospores germinate and produce primary mycelia. Four basidiospores from each basidium give rise to two different types of mycelia, two of + strains and two of – strains. (Fig 3.39)

4.2.6 Systematic position (After Ainsworth,1973):

Kingdom : Mycota

Division : Eumycota

Subdivision : Basidiomycotina

Class: Hymenomycetes

Order : Agaricales

Family : Agaricaceae

Genus : *Agaricus*

3.6 □ Mycorrhiza

It is a symbiotic association between fungus and roots of higher plants or between fungus and gametophyte of lower groups of plants in which the associated fungus and host both are mutually benefitted. A. B. Frank was the first person who coined the term **mycorrhiza** in 1885. There are three types of mycorrhizae, such as a) Ectomycorrhiza b) Endomycorrhiza and c) Ectendomycorrhiza.

3.6.1 Ectomycorrhiza

The salient features of ectomycorrhiza are as follows :

- i) Host fungus specificity is very rare in ectomycorrhiza that means one host plant may simultaneously get infected by many fungi. Thus it is observed that more than 5000 Asco and Basidiomycetous fungi can form ectomycorrhizal association in 2000 woody plants.
- ii) Ectomycorrhizal association is found only in 5% of vascular plants and it is predominant in the families like pinaceae, Fagaceae, Betulaceae, Juglandaceae, Myrtaceae and in other tropical and temperate families.
- iii) The mycelial growth doesn't proceed beyond the endodermis.

- iv) The mycelia form a thick layer on the root surface which may vary from 20-40 mm depending upon the species. Such thick covering is called mantle which prevents root to come in direct contact with soil particles. The fungal mycelia also form a network of hyphae in the cortical tissue; such hyphal network is known as hartig net.
- v) Morphogenetic changes of the root may occur due to ectomycorrhizal association. The infected roots may appear nodular, forked, biforked, multiforked etc.
- vi) The fungi forming ectomycorrhiza mostly belongs to agaric Basidiomycetes, Gasteromycetes, Ascomycetes, fungi imperfecti and occasionally Phycomycetes. (Examples: *Amanita muscaria*, *Boletus edulis*, *Laccaria laccata*, *Inocybe rimosa*, *Pisolithus tinctorius*). (Fig 3.40)

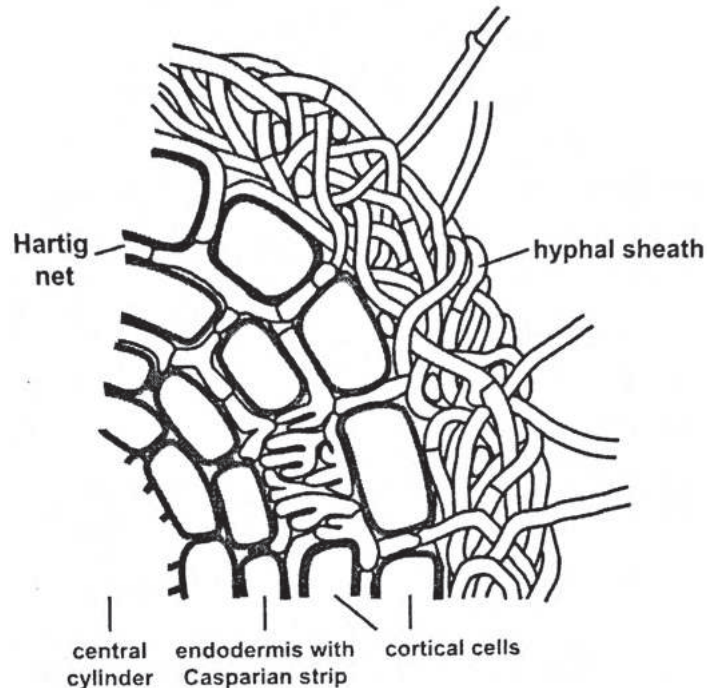

Fig. 3.40. Structure of a Ectomycorrhiza

3.6.2 Endomycorrhiza

The fungi involved in endomycorrhizal association not only show their growth on the surface of the root system but also their mycelia grow rapidly inside the deeper layer of

the tissue, even beyond the endodermis and form various structures during their intra and inter cellular growth. Unlike ectomycorrhiza, host specificity is noted in this type of mycorrhizal association. Based on their host specificity and structures produced during their growth inside the host tissue the following types of endomycorrhizae are found:

- i) **Vesicular arbuscular mycorrhiza (VAM):** This is the most common type of mycorrhiza found in the vascular plant. Over 90% of the vascular plants of world flora form this kind of mycorrhizal association. VAM is also known as arbuscular mycorrhiza or glomeromycotan mycorrhiza. This kind of mycosymbiotic association is very common in cultivated and wild species and also found in bryophytes, pteridophytes and gymnosperms (except Pinaceae). VAM forming fungi mostly belongs to the family Endogonaceae of Zygomycotina. The mycelia exhibit both inter and intra cellular growth. During intracellular growth the mycelia are dichotomously branched and severely folded to form a structure called **arbuscule**. These are considered as the sites for exchange of nutrients between host and fungus. The mycelia during their growth inside the host tissue form thin or thick walled oil rich spherical bodies filled with huge amount of reserve materials called vesicles. VAM are formed by hundreds of fungal species which belongs to six genera viz. *Acaulospora*, *Gigaspora*, *Glomus*, *Entrophospora*, *Sclerocystis* and *Scutellospora*. (Fig3.41&42).

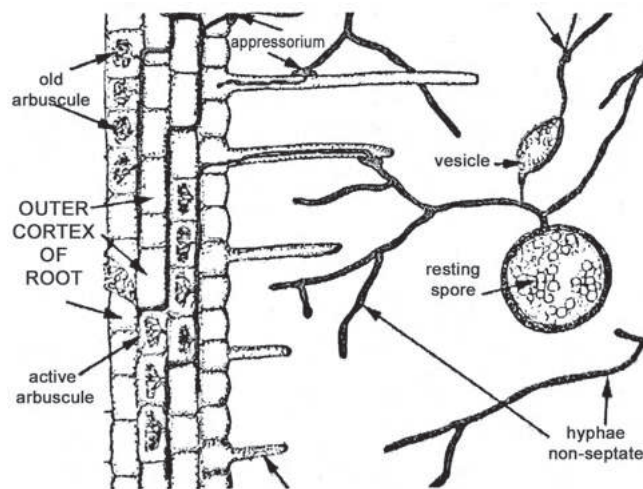

Fig. 3.41. Structural details of endomycorrhiza.

- ii) **Ericoid mycorrhiza:** Ericoid mycorrhiza occurs throughout the fine root systems in the tribe Ericoidae of the family Ericaceae (except tribe Arbutoidae).

Hymenoscyphus (Pezizella) ericae was first discovered as an ericaceous mycosymbiont. The plants like *Ephachris*, *Leucopogon*, *Monotoa*, *Rhododendron*, *Vaccinum*, etc. develop ericoid mycorrhizae. The fine root systems of these plants are usually infected. The mycelia usually do not produce arbuscules. The fungi forming Ericoid mycorrhiza mostly belong to ascomycetes, for example *Pezizella*, *Glvaria* spp. etc.

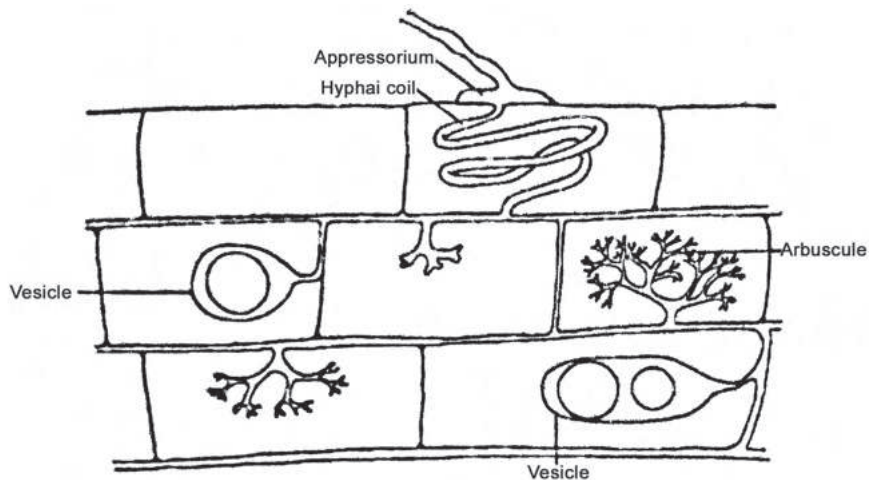

Fig. 3.42. Vesicular-arbuscular mycorrhiza showing both vesicles and arbuscules

- iii) **Arbutoid mycorrhiza:** This type of mycorrhiza was first discovered in the plant *Arbutus unedo*; a plant belongs to the tribe Arbutoidae of the family Ericaceae. Mostly the roots of woody shrubs and trees are infected by this type of fungi. The roots are called **herorrhizic** because infected short roots develop distinct sheath and Hartig net. The fungal mycelia form extensive coils of hyphae inside the cortical cells of root. The mycosymbionts mostly belong to Basidiomycetes.
- iv) **Monotropoid mycorrhiza:** This type of mycorrhiza is found in the members of the family Monotropaceae (e.g. *Monotropa hypopitys*). The plants of this family completely depend on mycorrhizal fungus for carbon and energy. The plant *Monotropa* characteristically forms root ball within which fungal mycelium grows enclosing the mycorrhizal roots of neighbouring green plants. The root ball serves as the survival organ of the plant during winter and on returning of favourable condition it gives rise to flowering shoots. *Monotropa* and associated trees are often connected by mycelium of a common mycorrhizal fungus *Boletus*.

- v) **Orchid mycorrhiza:** It is a symbiotic association between roots of the plants belonging to Orchidaceae and a variety of fungi. In nature orchid seeds could not germinate without the help of mycorrhizal association. As the orchid seeds are non endospermic, the embryo requires the help of mycorrhizal fungi as the source of carbon and energy. The non germinated seeds develop a stage in the life cycle called **protocorm** which is usually infected by mycorrhizal fungus. The infected protocorm grows into adult orchid plant. The fungi that form orchid mycorrhizae typically belong to the class Basidiomycetes. The range of taxa that belong to this class include *Sebacina*, *Ceratobasidium* (*Rhizoctonia*), *Tulasnella*, *Rusulla* etc. (Fig 3.43)

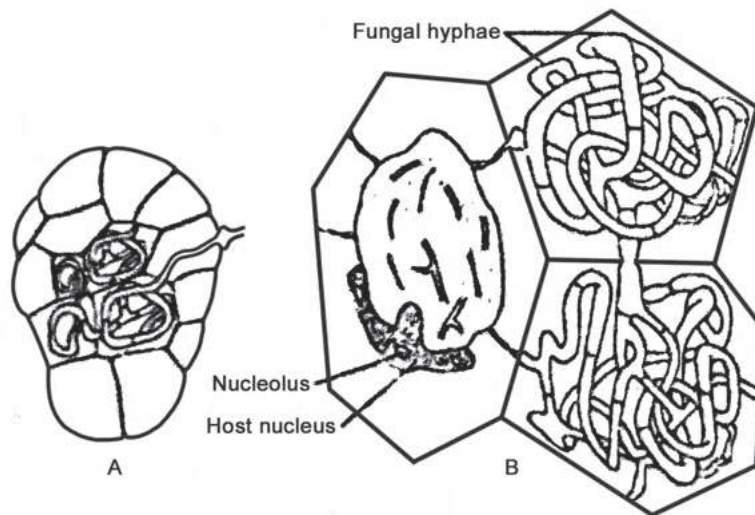

Fig. 3.43. Orchid mycorrhiza ; A Swollen embryo with initial infection, B. Cortical cells of *Dactylorhiza* root showing coiled active and lysed hyphae.

3.6.3 Ectendomycorrhiza

This type of mycorrhiza shares the characters of both ecto and endomycorrhiza. The mycelia grow on the root surface to form mantle from which some peg like hyphae penetrate into the cortex and perform intracellular growth. Both ectotrophic and endotrophic behaviour is noted in these fungi. This type of mycorrhizal association is found in the members of the order Pezizales (e.g. *Wilcoxina* spp. and *Sphaerospora brunnea*). In some fungal symbionts of this type though hartig net formation does not occur but intercellular hyphal coils in the cortical cells are noted.

Significance of mycorrhizae: Mycorrhizae play significant role in agriculture and forestry which are summarized below:

1. The stability of mycorrhizal roots is more than that of normal roots. The covering layer i.e. mantle formed by the fungal mycelia surrounding the roots help to retain moisture so that such roots could survive in drought condition.
2. The mantle layer surrounding the mycorrhizal roots increase the surface area and the roots become more capable of absorbing water and nutrients from the soil. Besides, the same layer on the mycorrhizal roots prevents frictional injury of the root surface. It is observed that the supply of different mineral elements like P, K, Zn, Cu etc. to the host plant having mycorrhizal infection in the roots is greater than the plants having normal uninfected root system.
3. In *Pinus* the root system lacks of sufficient number of root hairs. Such deficiency of the number of root hairs is compensated by the hyphae of mycorrhizal fungus which is the symbiotic inhabitant of the roots. The fungal mycelia growing on the root system absorb water from the soil and supply them to the underlying tissue of the root. Having water holding capacity the mantle forming mycelia prevent the roots from desiccation due to dryness.
4. Mycorrhizal fungi produce wide variety of biochemical compounds which are released into the rhizosphere of the host plant and induce the growth of diverse type of beneficial microbial population. Such beneficial microbial biomass includes nitrogen fixers, phosphate solubilizers, siderophore producers etc. The enhanced growth of beneficial microbes in the rhizoecological niche is known as **mycorrhizospheric effect**. Such effect is therefore considered as the indirect impact of mycorrhizae on the growth and productivity of the host plant.
5. Mycorrhizae play significant role in the solubilisation of insoluble phosphate in the soil. The soil in which available phosphate is low in respect of total P content, application of mycorrhizae in such soil has been proved very much effective to increase the availability of phosphate. In this regard the role of mycorrhizae may be direct or indirect. Indirectly, the mycorrhizae interact with the phosphate solubilising bacteria and by enhancing their population increase the availability of phosphate to the host plant. As a direct effect it has been proved experimentally that mycorrhizae produce some organic acids which help

to solubilise insoluble phosphate and make it available to the host plant. The vegetative mycelium of mycorrhizal fungus stores phosphate in the form of polyphosphate granules with the help of the enzyme polyphosphate kinase. Then inorganic phosphate is transferred to the host plant with the help of the enzyme phosphatase. In this way phosphate accumulates in the mantle and Hartig net and thereafter gets transferred from Hartig net to the host tissue. In this, the roles of VAM fungi are very important since they not only increase the phosphate availability of the host plant but also protect the host plant from phytopathogenic infection. It has been observed that inoculation of VAM in tomato plant doubles its growth and increase the number of leaves eight fold. It also lessens the number of days to flower than non-mycorrhizal plant. Significant increase in the height, panicle length, number of grains per panicle is observed in case of the rice plant inoculated with *Glomus*. Thus VAM fungi may reduce the negative effect of stress caused by water and nutrient deficiency.

6. Mycorrhiza plays very important role in the transfer of nutrients from host to host. The photosynthates are transferred from host to fungal symbiont and the same could be transferred to other different host where the fungal symbiont is a shared symbiont.
7. In horticultural practices mycorrhizae help in the induction of rootings of cuttings. This action is performed by the production of IAA from the mycorrhizal hyphae. The same hormone produced by the mycorrhizal fungi play immense role in morphogenesis and longevity of the roots.
8. Antagonistic substances released by the mycorrhizal fungi in the rhizosphere of the host plant prevents the growth of pathogenic microorganisms particularly root infecting pathogens and protect the host plant from different types of diseases. It has been proved that *Leucopaxillus ceralis* var. *piceina* produces antibiotic like substances which prevent the pathogenic infection of pine root.
9. In floriculture, mycorrhizal fungi are applied for orchid plant production. In nature orchid seeds could not germinate due to lacking of stored food in the seeds. Artificially, mycorrhizal fungi are applied to such seeds to induce germination.

3.7 □ Summary

Fungi are either eucarpic or holocarpic. The mycelium can be septate or without any septum. Clamp connection is observed in Basidiomycotina. Different types of mycelial aggregations are found in them. Cell wall is chitinaceous. Asexual reproduction takes place by various kinds of Sporangiospores or Conidia. Sexual reproduction takes place by plasmogamy followed by karyogamy. Different modes include gametangial copulation, gametangial contact, spermatization, somatogamy etc. *Penicillium* produces rami as a mode of asexually reproductive branching. Cleistothecium is produced as a result of their sexual reproduction. Asci are produced inside this structure. *Agaricus* is a common mushroom and can produce basidiocarp from secondary mycelia. Basidiocarp has gills which bear hymenium layer. Hymenium bears basidia with basidiospores. Mycorrhiza is a symbiotic association between fungi and roots of higher plants. They are basically of two types—Ecto and Endomycorrhiza. Another types Ectendomycorrhiza have characters of both. They are very important for transfer of nutrients from soil to host and from host to host. They also inhibit the growth of soil borne plant pathogens.

3.8 □ Exercises

Objective multiple choice questions:

1. The ascocarp of *Penicillium* is known as : a) Apothecium b) Cleistothecium c) Perithecium d) None of the above.
2. In Ascomycotina karyogamy occurs in : a) Ascogonium b) Antheridium c) Ascus d) Ascogenous hypha.
3. Which of the following is a coprophilous fungus? – a) *Ascobolus* b) *Puccinia* c) *Saccharomyces* d) *Penicillium*.
4. Which type of fruit body in fungi looks like a cup or saucer? – a) Apothecium b) Perithecium c) Cleistothecium d) Sclerotium.
5. Pseudomycelium is found in : a) *Synchytrium* b) *Rhizopus* c) *Mucor* d) *Saccharomyces*.
6. Ascogenous hyphae is produced from : a) Antheridium b) Ascogonium c) Ascogonium and antheridium both d) Ascus.

7. What is hysterothecium? a) unilocular perithecium b) Unilocular cleistothecium c) Unilocular ascostroma d) Bilocular and multilocular ascostroma.
8. The four nucleate stage of basidium is known as : a) Probasidium b) Metabasidium c) Holobasidium d) Basidium.
9. Dolipore septum is the characteristic feature of a) Ascomycetes b) Basidiomycetes c) Discomycetes d) Phycomycetes.
10. Which of the following type of spore is produced as a result of sexual reproduction? a) Zygosporangium b) Zoospore c) Conidia c) Chlamydospore.
11. Fairy ring producing fungus is : a) *Rhizopus* b) *Mucor* c) *Penicillium* d) *Agaricus*.
12. The fertile region of the fruit body of *Agaricus* is a) Pileus b) Hymenium c) Stipe d) Rhizomorph.
13. Where basidium is found in *Agaricus*? A) Gills b) Pileus c) stipe d) Rhizomorph.
14. Which class of fungi is known as 'Fungi imperfecti'? a) Zygomycetes b) Ascomycetes c) Basidiomycetes d) Deuteromycetes.
15. Which of the following processes is related to the growth of the mycelium? A) Clamp formation b) Binary fission c) Genome duplication and cell division c) clamp connection.
16. Which of the following mycelia plays major role in the formation of fruiting body? a) Primary mycelium b) Secondary mycelium c) Tertiary mycelium d) Secondary and tertiary mycelium.

Answers: 1(b), 2(d), 3(a), 4(a), 5(d), 6(b), 7(c), 8(b), 9(b), 10(a), 11(d), 12(b), 13(a), 14(d), 15(d), 16(c).

Answer the following questions:

1. Write the diagnostic features of fungi. (Ans. See the introduction section)
2. Define primary, secondary and tertiary mycelium in fungi. [Ans. See section 3.2(i)]
3. What is clamp connection? [Ans. See section 3.2(i)]
4. What is sclerotium? (Ans. See section 3.2)
5. What is stroma? (Ans. See section 3.2)
6. What is rhizomorph? (Ans. See section 3.2)

7. What is meant by dolipore septum? [Ans. See section 3.2(ii)]
8. What is lomasome? (Ans. See section [Ans. See section 3.2(ii)b]
9. What is Woronin body? [Ans. See section 3.2 (ii) c]
10. What is karyochoresis? [Ans. See section 3.2(ii)c]
11. What are the characteristics of the zoospore in fungi? [Ans. See section 3.3.2(i)]
12. Classify conidia on the basis of its developmental pattern. [Ans. See section 3.3.2(ii)]
13. Describe different types of conidial fructification produced in fungi. (Ans. See section 3.3.2)
14. Describe different types of ascocarp with diagram. (Ans. See section 3.3.4.1)
15. Define sterigmata. (Ans. See section 3.3.4.2)
16. Classify basidia on the basis of their structural morphology. (Ans. See section 3.3.4.2)
17. What is perisporeal sac? (Ans. See section 3.3.4.2)
18. What are ascogenous hyphae? (Ans. See section 3.3.4.1)
19. Write short notes on : a) Gametangial contact. (Ans. See section 3.3.5) b) Gametangial copulation(Ans. See section 3.3.5) c) Spermatization (Ans. See section 3.2.5) d) Somatogamy. (Ans. See section 3.3.5)
20. Draw and describe the conidial structure of *Penicillium*. (Ans. See section 3.4.2.1)
21. Draw and describe different types of sexual reproduction in fungi. (Ans. See section 3.4.2.2)
22. Draw and describe the structure of basidiocarp of *Agaricus*. (Ans. See section 3.5.2.5)
23. Define mycorrhiza. Classify mycorrhizae according to their structure. (Ans. See section 3.6.0)
24. What is VAM? Characterise VAM. (Ans. See section 3.6.2)
25. Describe the significance of mycorrhizae in agriculture and forestry. (Ans. See section 3.6.3).

Unit 4 Unifying Characters of Archaeogniatae

Structure

- 4.0 Objective
- 4.1 Introduction
- 4.2 Salient features of Archegoniatas
- 4.3 Summary
- 4.4 Exercises

4.0 Objective

After going through the unit, learners will be able to understand the salient features of the archaeogniate plants. They would realize how this group of plants were originated on earth through evolution. Learners will be able to describe the life cycle patterns, vegetative and reproductive features of these plants. They will be able to identify the plants belonging to this group from other plants growing in nature.

4.1 Introduction

Archaeogniatas are plants that bear archegonium as female reproductive organ. In plant kingdom the group of plants like Bryophytes, Pteridophytes and gymnosperms bear archegonium as their female reproductive organ and therefore these from a higher taxonomic group known as Archaeogniate.

The **archegonium** is a flask shaped female reproductive organ made up of mainly two parts such as **neck** and **ventre**. In algae the female reproductive organ is oogonium within which female gamete or egg nucleus is present. This oogonium is considered as precursor of archegonium. In some lower groups of algae, the structure of oogonium is simple and in some higher algal groups such as Charophyceae, the oogonium is more evolved and complex. This complexity in the structure of oogonium has evolved to provide more protection to the female gamete. Such type of complexity in oogonial structure in course of evolution has given rise to archegonium, which is more adapted in terrestrial environment.

According to Bower (1908) Archaeogniatae arose from aquatic ancestors. Among the aquatic plants the bryophytes resemble the green algae (Chlorophyceae) in the following

aspects ; 1) Starch as the metabolic product. 2) Nature of pigments in assimilatory tissue 3) Cellulose as the principal cell wall constituents. On the basis of such resemblances, it was concluded that Chlorophyceae was the nearest ancestral algal relative of the archegoniate bryophyte.

Fritsch (1916, 1945) postulated that the archegoniate plants have evolved from algal ancestor by the following evolutionary modifications in their structure:

- a) Firstly, heterotrichous thallus organization was originated in which there were two systems such as prostrate and aerial system. Differentiation in two systems is regarded as the probable starting point for the evolution of land forms. This habit is observed in the order Chaetophorales of the class Chlorophyceae.
- b) Next, parenchymatous structure was developed in the upright filament which is exemplified in the members of Fucales and Laminariales.
- c) Then, apical growing point in the aerial erect branch was established as found in Chaetophorales.
- d) Origin of dichotomous branching was the next evolutionary change that occurs in the aerial part of the plant body.

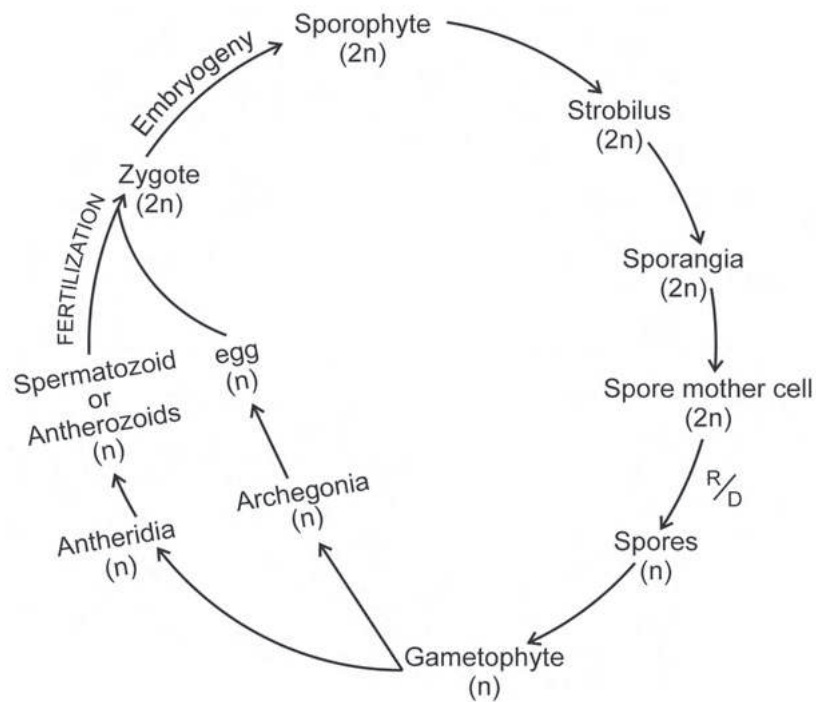

Word diagram 4.1. Life cycle pattern of a homosporous Archegoniate

- e) Elimination of prostrate system.
- f) Differentiation of vascular system in the aerial part as evidenced by the presence of sieve tube like element in *Macrocystis*.
- g) Development of cuticle on the surface of aerial axis.

According to Fritsch (1945) among the archegoniatae, the members of Bryopsida represent the evidence of their evolutionary origin from algae. The protonemal stage of mosses (Bryopsida) is considered as equivalent to the prostrate system of the heterotrichous filament of algae. The erect system of the heterotrichous filament on the other hand is considered as homologous to the stalked gametophore of the mosses.

4.2 □ Salient features of Archegoniates

- i) Among the archegoniates bryophytes are amphibians. They bear adaptive features to grow in aquatic as well as in terrestrial environment. Water is essential for them to accomplish the act of fertilization. The first land plant with vascular cylinder belongs to this group with all terrestrial features. The land plants with archegonia like pteridophytes and gymnosperms also belong to this group. The following characteristic evolutionary changes have been noticed among archegoniates:
 - a) Thalloid habit of bryophytes have changed or evolved to form arborescent habit in gymnosperms.
 - b) In primitive archegoniates like bryophytes the absorption and anchorage organ is rhizoids. Such structures have been evolved to form root system of higher archegoniates like gymnosperms concurrently with the evolution of vascular system.
 - c) In Bryophytes the thallus contains air pore through which gaseous exchange is made. Associated with the process of terrestrialization such pore was evolved into stomatal aperture.
 - d) In Bryophyte there is no vascular structure. Due to the growth in terrestrial environment vascular tissue appears first in pteridophyte in the form of protostelic organization. Clear evolutionary progress from prtostele to siphonostele is observed among the pteridophyte and the evolutionary process is culminated in gymnosperms by the formation of most advanced form of siphonostele.

- e) The sporophyte of early archegoniates like bryophytes were lacking in assimilatory organs and therefore were dependent on the gametophyte for food and nutrition, since the latter had photosynthetic tissue. In course of evolution assimilatory properties were acquired, which are represented by appearance of air pore in the sporophyte of Anthocerotales and development of spongy tissue with epidermal stomata like openings in the sporophyte of Bryopsida. Further evolutionary progress is noted in the members of primitive pteridophyte like Psilophyta, Lycophyta etc. where microphyllous leaves in addition to chlorenchymatous stem serves as assimilatory organ. In higher group of archaegoniates like gymnosperms and Filicopsida the megaphyllous leaves with leaf trace and leaf gap have evolved. Thus among archaegoniates a distinct evolutionary trend from a leafless to highly elaborate assimilatory megaphyll is seen.

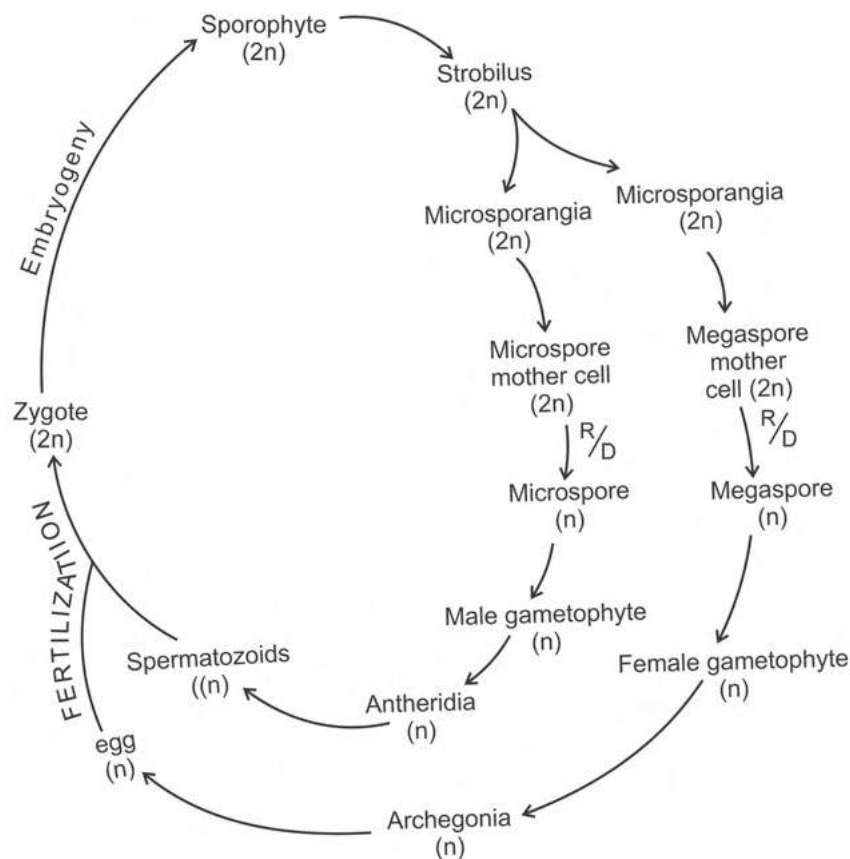

Word diagram 4.2. Life cycle pattern of a heterosporous Archegoniate.

- ii) In the life cycle of archaegoniates there are two distinct phases such as haploid gametophyte and diploid sporophyte. In bryophytes the gametophytic phase in the life cycle is predominant and the sporophytic phase is short lived and indistinct. In course of evolution the sporophytic phase becomes prolonged and independent. In Pteridophyte the span of gametophytic phase has become reduced. The maximum reduction in the span of gametophytic phase and elaboration of sporophytic phase is noted in archaegoniates like gymnosperms where the main plant body itself is sporophyte and occupies major part of the life cycle.
- iii) In archaegoniates the female reproductive organ archegonium is produced from an initial called archaegonial initial. The archegonium consists of two parts such as neck and venter. The neck contains cover cells at its apex and neck canal cells within (except in gymnosperms where neck canal cells in archegonium are absent). The venter is made up of ventral canal cell and egg. The archaegonia in Hepaticopsida remain embedded in the gametophytic tissue.

In hepatics like *Marchantia* the archegonia are found to be distributed on the lower surface of the rays present on the discs of the archaegoniophore. Archaeogonia in such cases remain protected by protective devices like pseudoperianth or perigynium.

In Anthocerotopsida the archaegonia are borne in clusters inside specialized cavity called archaegonial chamber. In the members of Bryopsida the archaegonia are found in a cluster on the apex of specialised branch called archaegonial branch. Such archaegonial cluster remains intermingled with hair like structure called paraphyses and protected externally by structures like perichaetal leaves. In pteridophytes, the archaegonia are distributed in female prothallus in heterosporous members and in prothallus of homosporous forms. In Gymnosperms the archaegonia are found in the female gametophyte formed inside the ovule. The archaegonial initials are originated from the primary haploid endosperm tissue situated towards the micropylar region of the ovule. The structural simplification of archaegonia is noticed in gymnosperms where the neck is indistinct and devoid of neck canal cells. In some advance gymnosperms like the members of Gnetopsida, the archaegonia formation is entirely absent and free female nucleus is formed in the female gametophyte without any archaegonia. So, from archaegoniates to higher non- archaegoniate gymnosperms, a clear trend of

evolutionary simplification in the structure of archaegonia and also a trend towards complete elimination of the same are observed.

- iv) Among archaegoniates the evolutionary trend from homospority to heterospority and ultimately to seed habit is a unifying feature. All archaegoniate bryophytes are homosporous. Some pteridophytes are homosporous where the spores are almost alike and on germination give rise to prothalli that bear both male and female sex organs (**Word diagram of life cycle pattern 4.1**). In other pteridophytes, the phenomenon of heterospority is manifested by the formation of two different types of sporangia such as larger megasporangia from which large megaspores are formed and smaller microsporangia from which small microspores are produced (**Word diagram of life cycle pattern 4.2**). The megaspores give rise to female prothalli which bear archegonia and the male prothalli are derived from microspores. Such heterosporous condition in course of evolution gives rise to seed habit as manifested in Gymnosperms.

4.3 □ Summary

Archegoniates and the plants which bear archegonium as their female reproductive organ they include Bryophyta, Pteridophytes and Gymnosperms. Thalloid habit of Bryophyta has gradually evolved to form absorbent habit of gymnosperms. In archegoniates there are two distinct phases in life cycle-haploid and diploid. In Bryophytes the predominant phase is haploid phase but in gymnosperms the sporophytic body is much more elaborate. The evolutionary trend that is observed in archegonites is from homospority to heterospority and ultimately develop the seed habit. The gametophyte in advanced members are reduced to prothallus. The megaspores give rise to female prothalli whereas the male prothalli are derived from microspores.

4.4 □ Exercises

Objective multiple choice questions

1. Archaeogoniates are: a) Bryophytes b) Pteridophytes c) Gymnosperms d) Bryophytes, Pteridophytes and Gymnosperms.
2. In which group of plants the archaegonium first appeared? A) Algae b) Moss c) Fern d) Gymnosperm.

3. Which group of plants gave rise to first land plant? a) Archaeogoniate b) Aquatic algae c) Fungi d) Bryophyte.
4. Which archaeogoniate group has short lived sporophytic generation? A) Bryophyta b) Pteridophyta c) Gymnosperm d) All the above.
5. First archeogoniate land plant with vascular bundle is a) Bryophyta b) Trachaeophyta c) Pteridophyta d) Thallophyta.

Answers: 1(c), 2(b), 3(a), 4(a), 5(c).

Answer the following questions

1. What are archaeogoniates? Why archeogoniates are called primitive land plants? (Ans. See section 4.1)
2. Draw and describe the structure of archegonium. (Ans. See section 4.1)
3. Characterise the life cycle of archaeogoniates. (Ans. See section 4.1)

Unit 5 □ Bryophyta

Structure

- 5.0 Objective**
- 5.1 Introduction**
- 5.2 Distribution**
- 5.3 General characters of Bryophytes**
- 5.4 Salient features of Hepaticopsida**
- 5.5 Salient features of Anthocerotopsida**
- 5.6 Salient features of Bryopsida**
- 5.7 Range of thallus organization in Bryophytes**
 - 5.7.1 In Hepaticopsida**
 - 5.6.2 In Bryopsida**
- 5.8 Ecological importance of Bryophytes with special mention of *Sphagnum***
- 5.9 Summary**
- 5.10 Exercises**

5.0 □ Objectives

After going through this unit learners would be able to differentiate Bryophytes from other cryptogamic plants. They will be able to explain the terrestrial and aquatic features of Bryophytes. They will understand the diversity among this group of plants in respect of their vegetative and reproductive structures. The learners will also be able to know how bryophytes could be exploited for ecological and economic purposes.

5.1 □ Introduction

Bryophytes are rootless, leafless, cryptogamic plants. The plant body is a thallus, without any conducting system and exhibits autotrophic mode of nutrition. The term bryophyte was first coined by Braun (1864). Bryophytes are commonly found to grow in highly humid terrestrial environment. They may grow on rock surface, old abandoned wall surface where water content of the substratum is very high. Though they grow in damp and humid places, water is essential requirement for fertilization to occur.

5.2 □ Distribution

Bryophytes possess many features of adaptation to grow both in aquatic and terrestrial environment and therefore they are considered as amphibians in plant kingdom. Besides the earlier mentioned common distribution range, bryophytes are found to grow in the following exceptional habitat:

Habitat	Examples
1. Fresh water aquatic environment (free floating)	1. <i>Riccia fluitans</i>
2. Fresh water aquatic environment (submerged)	2. <i>Riccia affinis</i>
3. Marine Bryophyta	3. <i>Scopania undulata</i>
4. Parasite on the bark of other trees	4. <i>Zygodon conoidens</i> , <i>Bryum capillare</i>
5. On the surface of the dead log of tree	5. <i>Papillaria flavolimbata</i>
6. On the leaves of other plant	6. <i>Cephalozia</i> , <i>Ephemeropsis</i> , <i>Crossomitrium</i> etc.
7. Marine habitat	7. <i>Barbula torquata</i> , <i>Torula princeps</i>

5.3 □ General characters of Bryophytes

- 1) The plant body is thalloid, dorsiventrally differentiated or sometimes the plant body is small stalk like gametophore which remains covered with spirally arranged leafy appendages.
- 2) The thalli remain attached to the substratum by **rhizoids**. The rhizoids are usually unicellular and are of two types such as **smooth walled** and **tuberculate**. In some members (e.g in *Funaria* of Bryopsida) the rhizoids are multicellular and obliquely septate. Rhizoids are usually associated with **multicellular scales** which also serve as absorbing and anchoring organ.
- 3) On the basis of morphological features of thallus, bryophytes have been categorized into three broad classes, such as a) **Hepaticopsida** (commonly called Liverworts) b) **Anthocerotopsida** (commonly called Hornworts) and c) **Bryopsida** (commonly called Mosses).
- 3) The vegetative body is devoid of conducting tissues like xylem and phloem.
- 4) There are two stages in the life cycle such as gametophyte and sporophyte. The former is haploid and dominant phase whereas the latter is diploid and short lived.

The sporophyte is incapable of assimilation due to lack of assimilatory tissue and therefore dependent upon the gametophyte for nutrition. The gametophyte bears sex organs. The male sex organ is called antheridium and the female sex organ is called archegonium.

- 5) The spermatozooids are motile and bear two flagella. The flagella are of smooth or whiplash type. The spermatozooids are carried by water current to the archegonia to bring about fertilization. Thus water is essential for the process of fertilization.
- 6) Zygote is the first cell of the sporophytic generation. Zygote is formed after fertilization within the archegonium and its subsequent development occurs within it following mitotic division. The zygote first divides transversely during the onset of embryogeny and the embryo that is ultimately produced following further divisions is known as **exoscopic** embryo. Embryo gradually differentiates into sporophyte.
- 7) The venter of archegonium in some hepatics divides periclinally and forms a protective layer surrounding the sporophyte which is called **calyptra**. The calyptra is therefore gametophytic in origin.
- 8) The sporophyte is usually differentiated into foot, seta and capsule. In some members sporophyte lacks seta (e.g. *Corsinia*). Foot and seta is completely absent in the sporophytes of some members (e.g. *Riccia*). In between foot and seta occurrence of meristematic zone is found in the members of Anthocerotopsida (e.g. *Anthoceros*).
- 9) The sporophyte develops spore producing organ or sporogonium from which numerous spores are produced. Inside the sporogonium there are spore mother cells which undergo reduction division to form haploid spores. The sporogonium in the members of Anthocerotopsida contains a sterile central strand called **columella**.
- 10) The spores produced from sporophyte are identical in shape and size and therefore are called homosporous. Inside the sporogonium of some members, hygrosopic devices like elaters, pseudoelelers etc. are developed from sterile sporogenous tissues which help in the dispersal of spores.
- 11) Spore is the first cell of gametophytic generation. It germinates to form an initial filamentous structure called **protonema** on which buds are formed, such buds are gradually differentiated into thalloid gametophyte or stalked gametophores.
- 12) The alternation of generation in Bryophyte is heterologous type, that is gametophytic and sporophytic phase in the life cycle are morphologically dissimilar.

5.4 □ Salient features of Hepaticopsida:

- (i) The plant body is green, thalloid, dorsiventrally differentiated. On the ventral surface of the thallus unicellular rhizoids and multicellular scales are present. Rhizoids are of two types such as **smooth** walled and **tuberculate**.
- (ii) The vegetative cells are of two types such as chloroplast containing cells and colourless, storage parenchyma cells. In the latter type storage materials in the form of oil bodies are observed.
- (iii) The sex organs (male antheridium and female archegonium) remain embedded in the vegetative tissues of the thallus. In some members antheridia and archegonia are produced on a specialised stalk developed from the thallus called antheridiophore and archegoniophore respectively.
- (iv) With some exceptions (e.g. *Marchantia*), the sporophyte may be simple in its structure and does not show any differentiation into foot, seta and capsule. The sporophyte is entirely dependent on gametophyte for its nutrition.
- (v) The sporogenous tissue is derived from **endothecium**. The zygote divides and re divides to form a mass of tissue which on periclinal division forms two layers, the outer amphithecium and inner endothecium.
- (vi) In some members the sterile sporogenous tissue gives rise to hygroscopic, both ends tapering, spirally thickened, unbranched sterile structure called **elaters**. The elaters help in the release of spores from capsule. In some members (e.g. *Riccia*) the sterile sporogenous tissue forms nutritive tissue for the spore mother cells called **nurse cells**. **Fig. 5.1**

Example : *Riccia*, *Marchantia* [Fig.5.2]

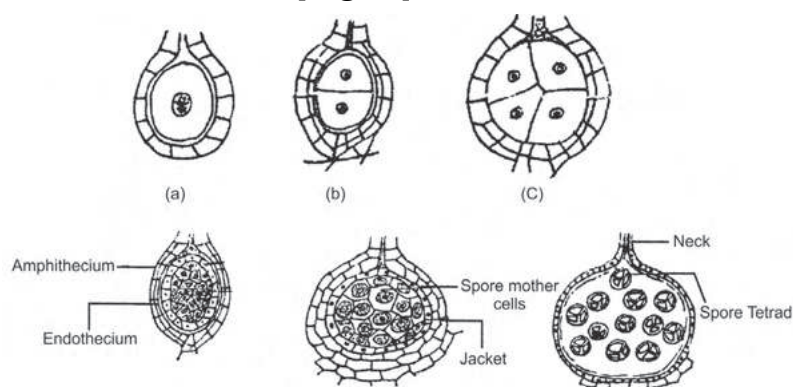

Fig. 5.1 : Different stages of the development of sporophyte of *Riccia* (a – f). [For description see the text]

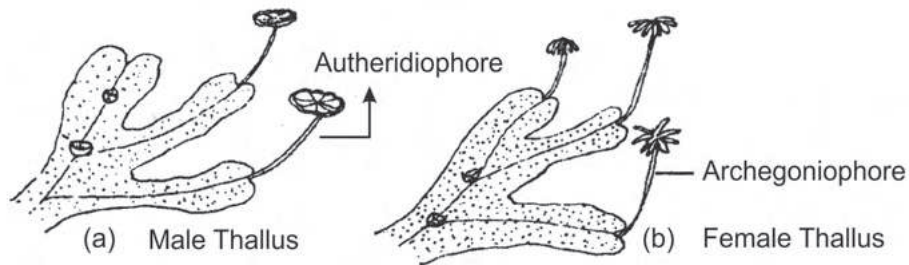

Fig. 5.2 : Morphology of the gametophyte of *Marchantia*. (a) Male gametophyte, (b) Female gametophyte.

5.5 □ Salient features of Anthocerotopsida

- (i) Plant body is thalloid, dorsiventrally differentiated, sporophyte attached to the gametophyte appears horn like in structure and therefore the members are called hornworts.
- (ii) From the ventral surface of the thallus unicellular rhizoids are produced. No scales are found.
- (iii) Internal tissue differentiation in the thallus is absent. The vegetative cells of the thallus are homogeneous, contain chloroplast with pyrenoid.
- (iv) The antherial and archegonial clusters remain embedded in the antheridial and archegonial chambers respectively. Such sex organ bearing chambers are produced inside the thallus.
- (v) The sporophyte is elongated, cylindrical, differentiated into foot, meristematic zone and capsule. It is developed from the dorsal surface of the thallus. Due to the presence of meristematic tissue, the sporophyte can exhibit unlimited growth.
- (v) A central sterile strand derived from the endothecium is found in the sporophyte and it is called **columella**. It provides mechanical strength to the sporophyte.
- (vi) The sporophyte is externally covered by multilayered cells, which contain chloroplast and intercellular spaces. Stomata like pores are also observed on the wall of the sporophyte. The wall of the sporophyte is derived from outer amphithecium.

- (vii) The inner amphithecium gives rise to sporogenous tissue. The sporogenous tissue gives rise to a sterile blunt ended, branched, transversely septate, hygroscopic structure in addition to fertile spore mother cells; such sterile structures are called **pseudoelelers**. It helps in spore dispersal from the capsule.

Example; *Anthoceros* [Fig 5.3]

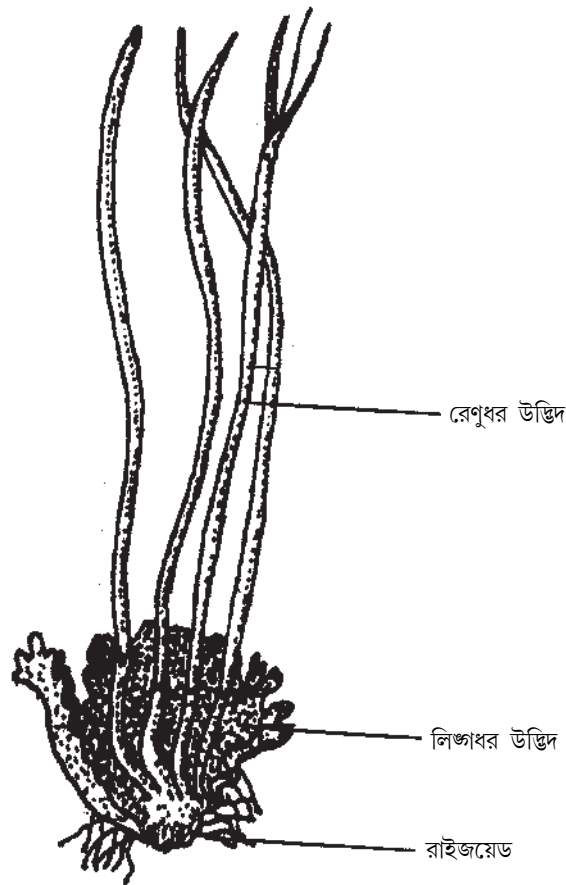

Fig. 5.3 : Morphology of the plant body of *Anthoceros*.

5.6 □ Salient features of Bryopsida

- (i) The gametophyte is made up of filamentous protonema and vertically elongated stalk like gametophore. The basal end of the gametophores contains a bunch of multicellular branched rhizoids. The gametophore is covered with small spirally arranged leaf like outgrowth. [Fig 5.4]

- (ii) The sexorgans are developed in aggregate or clusters at the apex of the branch of gametophores. The branches bearing antheridial and archegonial clusters are called antheridial and archegonial branch respectively.

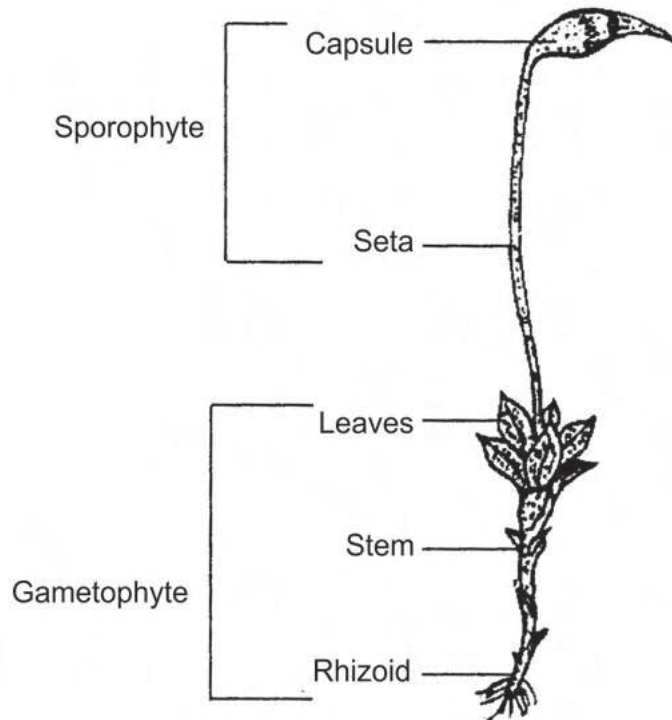

Fig. 5.4 : Morphology of the gametophore of *Funaria*.

- (iii) Some hair like structures are found to remain intermingled with antheridial clusters. Such hairs like structures are called **paraphyses**. Both the antheridial and archegonial clusters remain covered outside by much thin leaf like structures called **perichaetial leaves**.
- (iv) The sporophyte is differentiated into foot, seta and capsule. Seta is slender, long, and bear capsule at the apex.
- (v) At the basal region of the capsule there is a swelled region with centrally located spongy tissue called apophysis. Stomata are found on the wall of the apophysis.
- (vi) Columella is present at the central region of capsule which is derived from inner endothecium. The outer endothecium gives rise to sporogenous tissue.
- (vii) No elaters and pseudoeleters are found in the capsule. The spores are produced inside a sac like structure of the capsule which is called spore sac.

- (viii) At the apex of the capsule cap like **operculum** is found which is detached off from the apex of the capsule on maturity.
- (ix) Just below the operculum 32 teeth like structures are arranged in two alternating rows (16+16) in the form of a ring, such teeth like structures are called **peristome teeth**. Peristome teeth play significant role in the dispersal of spores from the capsule.

Example: *Funaria*, *Pogonatum*, *Polytrichum* etc. [Fig. 5.5]

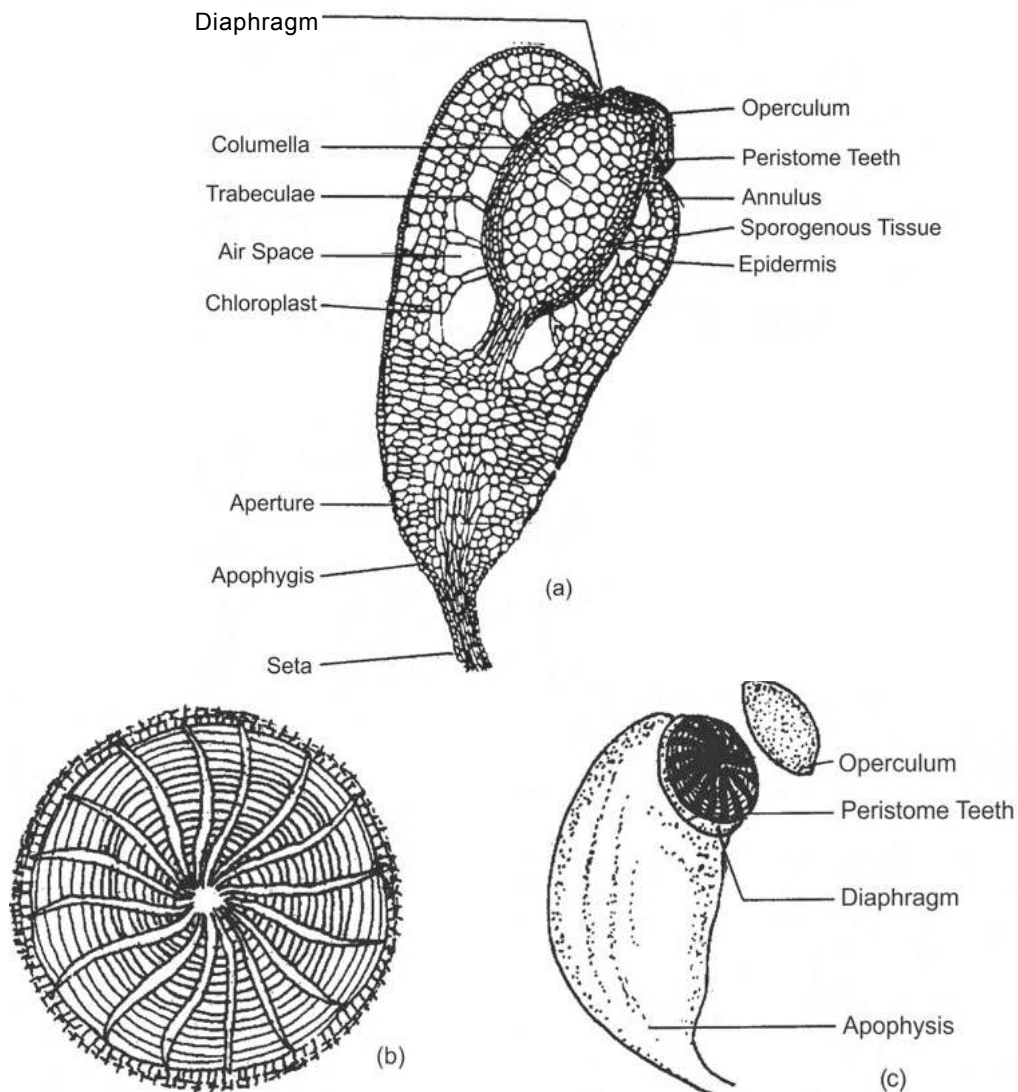

Fig. 5.5 : (a) VLS through the Capsule of *Funaria*, (b) structure and arrangement of peristome teeth. (c) Top view of the apical portion of the capsule of *Funaria*.

5.7 □ Range of thallus organization in Bryophytes

A great diversity of thallus organization is noticed in Bryophytes. On the basis of morphology the thalli of Bryophytes have been classified into two broad categories, such as: i) **Thallus like gametophyte or thallose** and ii) **leafy gametophyte of foliose**. Sufficient differences in thallus organization exist between the two. The variability in size of the thalli is also noted in Bryophytes. The smallest Bryophyte is *Zoopsis argentea* which is only few mm in length. (**Fig 5.6 A & B**). The longest plant body in bryophyte is noted in *Frontinalis antipyretica* which is about 50-70cm in length. Among thalloid gametophytes the largest plant body is found in *Monoclea forsteri*. Its length and breadth may be upto 20cm and 5cm respectively.

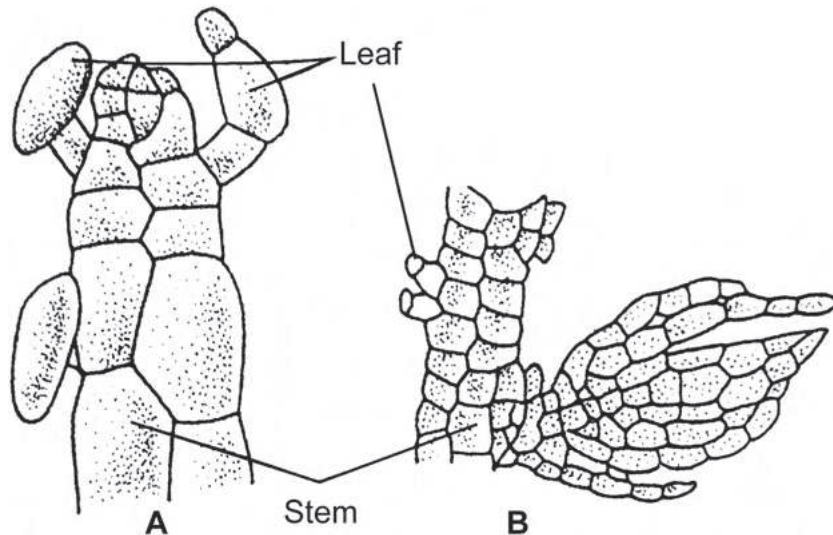

Fig. 5.6 : **A.** Immature plant of *Zoopsis argentea* where the leaves are arranged in three rows. **B.** Part of a mature plant.

i) **Thallose Gametophyte:** Thallose gametophyte in bryophyte is considered as primitive and this type is observed in the orders Marchantiales, Jungermanniales and in the class Anthocerotopsida. The thallus is dichotomously branched, dorsiventrally differentiated and green with rhizoids emerging out of the ventral surface of the thallus. Thalli have a distinct midrib along the length as found in *Riccia*, *marchantia*, *Podomitrium*, *Metzgeria*, *Dendroceros* etc. In the genera like *Monoclea*, *Riccardia* etc. the thallus is lacking of any midrib. Extensive variation in respect of dichotomy of the thalloid gametophyte is observed among the different members. In *Riccia* and *Marchantia* the dichotomies are very closely located and the thalli are aggregated to form rosette organization. In *Riccardia*, the dichotomy

is unequal and the one axis of dichotomy is considerably larger than other. The shorter branches of the dichotomies appear as lateral branches and give rise to pinnate branching pattern of the thallus. One to three times repeated dichotomy of the thallus is observed in *Cosima* and *Monoclea*. In *Targionia* though number of dichotomy is limited but from the midrib towards the ventral surface many adventitious branches are produced. The members of Metzgerineae (e.g. *Hymenophyllum*, *Makednothallus* etc.) are characterized by the presence of a rhizoid bearing rhizomatous prostrate axis from which multiple cylindrical aerial erect branches are produced which are dichotomised repeatedly to form a fan shaped photosynthetic thallus organization.

In *Treubia insignis*, the gametophyte is made up of a cylindrical prostrate fleshy axis on which large leaves are arranged in two rows. Besides, scale like leaves are also found to be arranged on the dorsal surface of the axis in two alternate rows. In *Fossombronia* also lobed leaves are found to be arranged on the axis in two rows. In Metzgeriales and Sphaerocarpaceles the axis of the gametophyte is flat and bears small leaves on it which are arranged in definite rows. All these type of thallus organization is considered as the intermediate between the thallose and foliose type.

Leafy form or foliose gametophyte: This type of thallus organization is found in the members of Hepaticopsida and Bryopsida.

5.7.1 In Hepaticopsida

The foliose form of thallus organization found in the following orders of this class:

- i) **Sphaerocarpaceles:** In *Sphaerocarpos* the gametophyte is made up of a dichotomously branched central axis on which leaves or lobes are arranged in two different lateral rows in an alternate manner. Besides, central or middle lobes are present on the axis ahead of the point of dichotomy. These middle lobes are called **angle leaves**. In *Geothallus*, in addition to middle lobes a projection called **lappets** is found on the dorsal surface on the axis. The presence of air pockets in the gametophyte of this plant is another important feature.
- ii) **Calobryales:** Here the gametophyte is characterized by underground leafless, rhizoid less, rhizomatous axis, from which many aerial erect leafy axes develop. On the axis many flat, isometric leaves are arranged in three different rows. The leaves in one row are characteristically smaller than other two (Example: *Calobryum*, *Haplomitrium*).

- iii) **Takakiales:** *Takakia* is the only member of this order. The gametophyte of this plant is subterranean, rhizomatous and rhizoid less from which isophyllous type of aerial stem is produced. The leaves of the gametophyte are bifid towards the base.
- iv) **Jungermanniales :** The members of this order where the gametophytes are leafy are called **acrogynous jungermanniales**. Here the leaves are arranged in three rows. Two dorsal rows on the lateral side and one ventral row of small or minute leaves. The latter are called **amphigastria**. The amphigastria may be either reduced or absent in *Plagiochila asplenoides*, *Marsupella emarginata*. The amphigastria and other dorsal lateral lobes are identical in shape and size in *Herberta aduncea*. (**Fig 5.7**) Variability in respect of morphology of the leaves among the gametophytes is observed. The leaves are bilobed in *Lophocolea* and *Herbesta*, trilobed in *Bazzania trilobata* and tetralobed in *Trichocolea tomentella*. The lateral leaves are generally arranged in a single

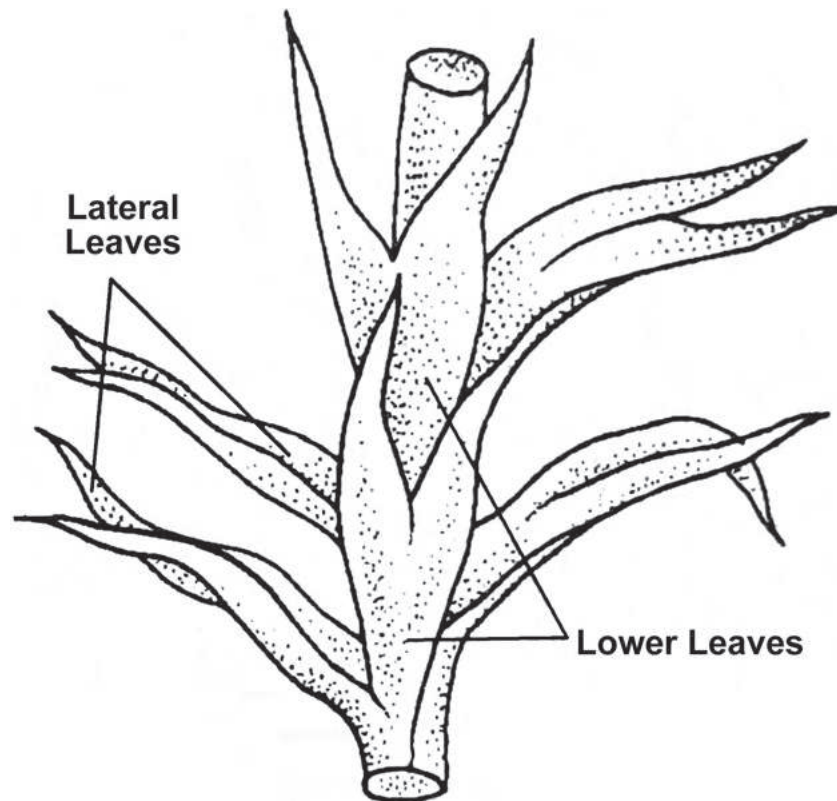

Fig. 5.7. Arrangement of leaves on the ventral surface of aerial axis of *Herberta aduncea*. The leaves are bifid and arranged in three rows.

plane. In others the leaves form a **complicated bilobed** organization. In such organization the lateral leaves are not arranged in a single plane and being folded they form a constriction at their junction called **keel**. The leaves of the complicated bilobes may be identical (e.g. *Marsupella*) or different. Where different, the ventral lobes are called **postical lobe** and the dorsal lobes are called **antical lobe**. In *Porella* and *Radula* the antical lobes are larger whereas in *Scapania* and *Diplophyllum* the postical lobes are larger. The antical and postical lobes in *Porella* and *Radula* are called **lobes** and **lobules** respectively. (Fig 5.8 A, B

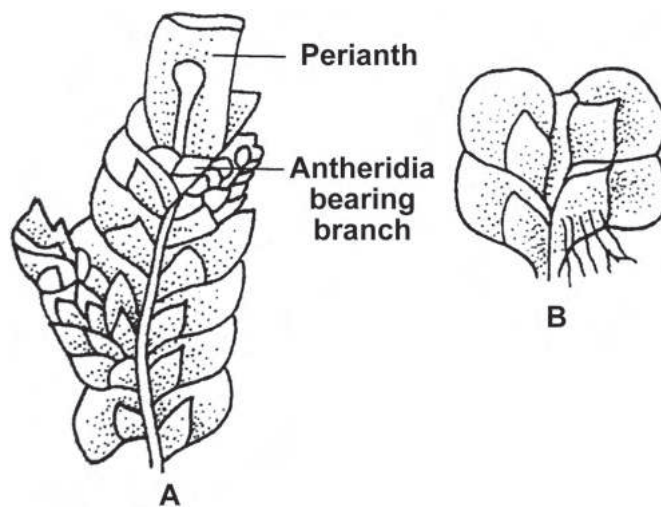

Fig. 5.8. Axial leaves are absent on the ventral surface of the gametophyte of *Radula complanata*

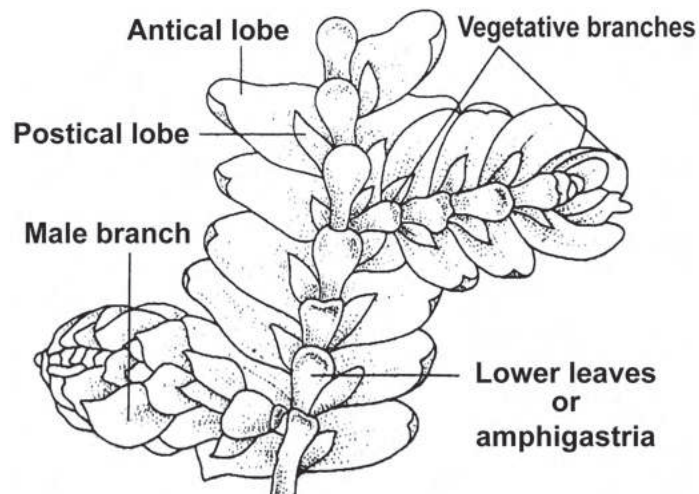

Fig. 5.9. Arrangement of leaves on the gametophyte of *Porella*.

& 5.9) In *Frullania*, the smaller ventral lobes are differentiated into **stylus** and **lobules**. The lateral lobes in some genera of the family Lejuniaceae constitute water sac whereas in Frullaniaceae only lobules take part in the formation of water sac. In *Lepidolaena*, the water sacs are helmet shaped and both the lateral and ventral leaves are involved in their construction.

The leaves of the lateral lobes are transversely arranged and they may become obliquely placed due to disproportionate growth of the dorsal and ventral surface of the axis. When growth of the dorsal surface of the axis becomes more, it gives rise to **succubus arrangement** where the apical end of the leaves remain attached with posterior end of the upper leaves growing in the same side (e.g. *Chiloscyphus polyanthus*, *Lophozia hatchery*, *Cephalozia* etc.). More growth of the gametophytic axis at the ventral surface gives rise to **incubous arrangement**, where the anterior end of leaves remain in an overlapping manner with the posterior end of the upper leaves located on the same side of the axis (e.g. *Bazzania trilobata*, *Calypogeia neesiana*, *Porella platyphylla* etc.).

Two types of branching patterns are observed among the members of acrogynous jungernanniales, such as (i) Terminal branching and (ii) Intercalary branching. In terminal branching existence of a single leaf is visualized at the base of each branch. This type of branching pattern is observed in the genera like *Frullania*, *Porella*, *Microlepidozia* etc. The intercalary branches usually develop from the lateral and ventral surface of the axis. This type of branching pattern is observed in the genera like *Micropterygium*, *Scapania*, *Plagiochia*, *Herberta* etc.

5.7.2 In Bryopsida

The members of this class are commonly known as mosses. The gametophytic plant body is stalk like and called gametophore which may be very small and microscopic (e.g. *Buxbaumia*, *Ephemerum*, *Ephemeropsis* etc.) or may be enlarged and may attain upto 40-70 cm (e.g. *Dawsonia*) height. The gametophore is leafy. The leaves are very small, sessile and simple with serrated margins, spirally arranged. **(Fig 5.10)** In *Fissidens* and *Bryoxiphium*, the leaves are arranged in opposite manner. The branching pattern of the gametophore is always lateral and never axial. Dichotomous branching pattern is absent in mosses. The lateral branches are emerged from the lower surface of the leaf. Based on the branching pattern, the mosses have been classified into two types such as: a) **Acrocarpus mosses** and b) **Pleurocarpus mosses**.

In **acrocarpous mosses** number of lateral branches is less. The axis of the gametophores is straight and its growth becomes limited due to the development of the cluster of archegonia at the apex. The sporogonium is terminal in position due to the terminal position of the female sex organ that is archegonium. The lateral branches develop below the terminal archegonial cluster either singly or in opposite pair or sometimes in whorl.

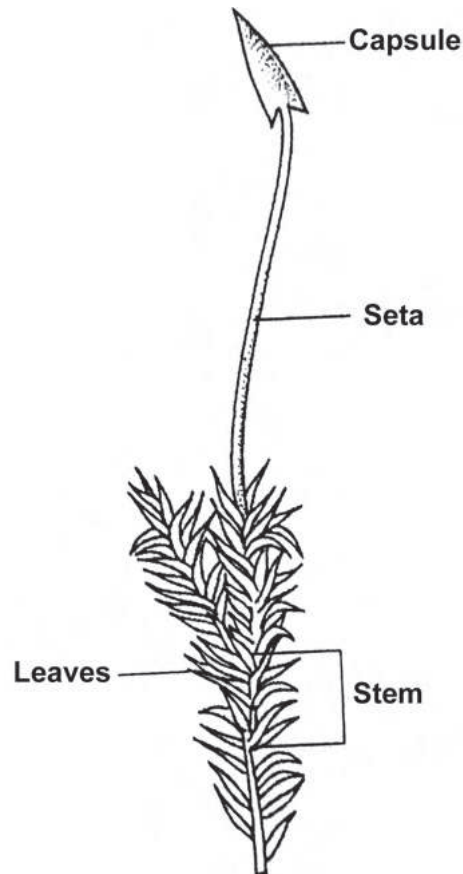

Fig. 5.10. Sporogonium bearing female plant of *Polytrichum Commune*.

In **pleurocarpous mosses** the gametophore is prostrate, from which pinnate branching pattern develops laterally. The lateral branches divide repeatedly and form bipinnate or tripinnate types of branching pattern. The archegonial clusters are produced on the apex of lateral branches instead of the apex of the main axis. So the growth of the main axis of the gametophores is unlimited and the length of the axis of the gametophores is comparatively greater than acrocarpous mosses. In *Climacium dendroides* and *Thaumatococcus alopecurum* the gametophores is prostrate from which secondary branches are produced. Whorls of

lateral branches towards the apex of such secondary axis produce a dendroid type of thallus organization. In some members of Hepaticopsida (e.g. *Trichocolea tomentella*, *T. paraphyllina* etc.) and Bryopsida (e.g. *Plagiothecium deplanatum*, *P. geophyllum* etc.) a small chlorophyllous outgrowth is found at the base of the leaves or at the base of the branches. Such outgrowths are called **paraphyllia**. Such paraphyllia form capillary films that play role in water holding and absorption like sponge. They also help in external capillary conduction.

5.8 □ Ecological importance of Bryophytes with special mention of *Sphagnum*

Bryophytes are important component of ecology. The ecological role of bryophytes can be discussed under the following heads:

- a) **Role of Bryophytes in plant succession:** Succession is a natural phenomenon in which a plant community is gradually replaced by other plant community due to some topographical changes in the substratum in which they grow and such process of replacement continues until a stable or permanent vegetation is established. Each stage of succession is called sere. Bryophytes play significant role in the constitution of seral stage. Bryophytes grow in the area where nutrient concentration and water holding capacity is very low. They form a dense mat like vegetation in such area and by their repeated death and growth cycle the substratum becomes rich in humus and favourable for the growth of microorganisms. The growth of microorganisms changes the nutritional parameters of the site and makes it suitable for the growth of other plant community. In addition, the increased water holding capacity of the substratum is also responsible for the colonization of herbaceous plant community. It has been recorded that *Saxifraga cotyledon* germinates only among the mosses. The other rock loving species which usually appear in the moss mats are *Sedum*, *Thymus*, etc. Thus bryophytes play significant role in the succession like xerosere (where succession begins in the water xeric environment) and litho sere (where succession begins on stone surface).
- b) **Role of Bryophyte in animal succession:** The growth of mosses in the form of dense mat creates an environment favourable for the growth of different animals like rhizopods, rotifers, nematodes and ciliates. Thus the moss population

in a particular area constitute a substratum that helps in the colonization of soil fauna. Snails and slugs are found to lay their eggs inside the layer made by gametophore of mosses. Different animals like spiders, millipeds, centipeds, crustaceans etc. make their existence in the bryophyte community because such community provides biological resources for their survival.

- c) **Role of bryophyte in nitrogen fixation:** Some nitrogen fixing cyanobacteria colonize inside the thallus of bryophyte as endophytic member. *Nostoc* is an ideal example of such type of endophytic association found in the thallus of *Anthoceros*. The alga enters through the slime pore of the thallus and form endophytic colony inside a chamber in the thallus called mucilaginous cavity. Being heterocystous, the alga can fix atmospheric nitrogen. So the growth of *Anthoceros* in the agricultural field is the indicator of high nitrogen content of the soil.
- d) **Role of bryophyte in controlling soil erosion;** Dense mat formation by bryophyte population on soil surface reduces the rain water flow and facilitates the percolation of water below the surface layer. Thus surface soil remains protected from being eroded by rain water current. The rhizoidal mass in addition to scales of the gametophyte of bryophytes holds soil particles tightly and prevents their transport by various means.
- e) **Role of bryophyte in maintaining water balance in forest ecosystem:** Bryophytes particularly some mosses and *Sphagnum* could hold huge amount of water and moisture. The growth of such bryophyte population in rain forest helps to keep the environment moist and cool. Such environment having huge moisture facilitates the growth of different moisture loving plant species. It has been suggested that the huge water and moisture retaining ability of bryophytes might have role in the controlling flood like natural disaster.
- f) **Ecological importance of Sphagnum:** The dead parts of the plant body of *Sphagnum* are partially decomposed by water in bogs and accumulates at the bottom year after year and form a compact carbonised dead plant deposit called the **peat**. Peat is brown in colour and a spongy substance. As *Sphagnum* plays significant role in the formation of peat, it is called as **peat moss**. Sphagnum peat has the following economic value: i) The thick deposits of peat are cut into blocks and dried. Being rich in carbon the dried peat blocks are used as fuel.

There are many factories in foreign countries like France where peat is used for making illuminating gas. ii) Cellulose present in the peat is broken down into sugar by chemical treatment which on fermentation produces ethanol. iii) Peat is used to obtain ammonium sulphate as by-product during production of gas from it iv) Nitrates, brown dye and tanning materials are produced from peat. It is also used in the production of ammonia, peat tar and paraffin. v) Peat is employed as mattress filler and bedding material for domesticated animals after removing sticks and coarse materials from it. vi) *Sphagnum* peat is added to the soil to improve its texture and water holding capacity. It also helps to increase the humus and organic content of the soil. vii) Cleansed peat of *Sphagnum* is used for preparation of bed for germination of seeds. It is also used as a packing for grafting scions to protect them against drying influence of the surrounding air. viii) Peat is used as a packing material for fruits, fish, eggs and meat for cold storage.

Due to high moisture retaining ability dried *Sphagnum* is used as a packing material for shipment of living plants, vegetables, cut flowers, perishable fruits, bulbs and tubers. Peat moss serves as a suitable material for surgical dressing because of its great absorbent power and slight antiseptic properties. *Sphagnum* dressing has been proved cooler, softer and less irritating than those made with cotton. The plant body is cleansed, dried and sterilized and is employed as a substitute of gauze to dress wounds and making absorbent bandages in the treatment of boils and discharging wounds.

- g) Bog succession:** *Sphagnum* plays significant role in bog succession from open water to climax forest. Due to excessive growth of the plant in shallow water body or lakes, a dense mat like vegetation is formed giving the appearance of solid soil. Such areas are called **quacking bogs**. Because of high moisture content of that area the site becomes favourable for the germination of seeds of hydrophytic plants and small herbs. The older parts of these plants including *Sphagnum* gradually die and settle at the bottom after detachment. Thus such shallow water bodies or lakes in course of time become filled with partially decomposed old parts of mosses and other hydrophytic plants. So the area which was originally a sterile sheet of water, become converted into solid soil supporting vegetation. Eventually the small hydrophytic plants including herbs disappear and replaced by mesophytic type. Thus *Sphagnum* plays role in bog succession from open water to climax forest.

- h) Role of mosses as rock builder:** Many mosses like *Bryum*, *Hypnum*, *Fissidens* and others grow in association with algae (like *Chara*) in shallow lakes and water body rich in calcium bicarbonate. Such plants cause decomposition of bicarbonate ions by abstracting free CO_2 and precipitate insoluble calcium carbonate. The latter on exposure hardens to form calcareous rock like deposits around these plants. The travertine rock deposits are used as a building stone.
- i) Medicinal importance of Bryophytes:** There are scanty reports on the medicinal importance of bryophytes. Still, many species are considered useful for treatment of various ailments. *Marchantia polymorpha* is used to cure pulmonary tuberculosis and affliction of liver. The species has been reported to have anti tumour property. The species like *M. stellata*, *Polytrichum commune* etc. also have the same property. The tea like extract obtained from *Polytrichum commune* is used as a drink to remove kidney stone. The decoction of *Sphagnum* is used in the treatment of acute haemorrhage and diseases of the eye. According to Grieve (1931), a distillate of peat tar known as sphagnol has been effectively used in the treatment of skin disease. *Sphagnum* is used for making absorbent bandages. Besides, many species of Bryophytes have antibiotic properties. Hayes (1947) reported that aqueous extract of *Conocephalum conicum* is antibiologically active. It has been reported that two species of *Sphagnum* (*S. Portoricense* and *S. strictum*) has antibacterial property. They are found to inhibit the growth of *Staphylococcus aureus* and *Pseudomonas aeruginosa* in vitro.
- j) Use of Bryophytes as food:** Bryophytes are not directly used as food. However, there are examples of domesticated animals using bryophytes as their food. Lid and Miedell (1933) reported that the capsule of *Bryum* and *Polytrichum* constitute the chief diet of Norwegian grouse chicks. Hone (1934) and others reported that Alaskan reindeer grazes upon *Polytrichum*, *Aulacomnium turgidum* and *Hylocomium alaskanum*. Haines (1877) reported that *Sphagnum* is used as an ingredient in the preparation of bread by the tribal people called Laplander. *Physcomitrella patens* is a good example of edible bryophyte whose protein content is very high (more than 70%).
- k) Use of Bryophytes as pollution indicator:** Bryophytes in general are sensitive to air pollutants. Due to the high sensitivity to air pollutants, bryophytes are

found to grow densely in the hilly areas where the level of pollutants is comparatively low. On the other hand, bryophyte population is scanty in the industrial area because high concentration of industrial pollutants in the atmosphere. There are many bryophytes which can tolerate the existence of high level atmospheric pollutants. The existence and rich growth of such tolerant bryophyte population serves as an indicator for the occurrence of high level of pollutants in the atmosphere. Bryophytes in general cannot tolerate the atmospheric SO₂ concentration beyond 0.017 ppm as it cause rapid mortality of bryophyte population. Nevertheless, some exceptional members of bryophytes are there (such as *Bryum argenteum*, *Ctenidium molluscum* etc.) which can grow in the areas where the So₂ concentration exceeds beyond that limit. The growth of such bryophytes indicates atmospheric pollution by SO₂.

A new concept of **bryometer** has come up in this regard. It is a glass made chamber in which bryophytes are grown in a controlled environment where different concentration of pollutants are supplied artificially to study the growth and behaviour of plant body of a particular species in respect of that pollutant level. The tolerance limit of different pollutants by different species of bryophytes could also be determined with the help of such device. *Orthotrichum obtusifolium* is a hyperaccumulator of fluoride and serves as fluoride indicator.

Besides, bryophytes can absorb different heavy metals like lead, mercury, zinc, cadmium etc. from soil and accumulate in their vegetative body in a high concentration. Thus they play significant role in the removal of harmful metals from soil. *Sphagnum fimbriatum*, *S.memorum* etc. can accumulate cadmium (Cd) in their body and therefore can serve as indicator of heavy metal pollution. Similarly, *Dicranella varia* and *Aerobryopsis longissima* serves as indicator of lead (Pb) and Chromium (Cr) respectively.

5.9 □ Summary

Bryophytes are rootless, leafless cryptogamic plants. Thallus is without any conducting tissues. Rhizoids are rootlike structures which remain attached to the substratum. Hepaticopsida and Anthocerotopsida are completely thalloid. Members of Bryopsida are called mosses. The vegetative body is devoid of xylem and phloem. Hepaticopsida have dorsiventrally differentiated structure. The sporogenous tissue is derived from endothecium in them. Anthocerotopsida also has dorsi-ventrally differentiated thallus. Mosses have comparatively elaborate sporophytic body which bear peristome teeth which aid in spore

dispersal. Bryophytes are important in plant succession and control soil erosion. *Sphagnum* is known as reat moss. Some have medicinal importance. They are pollution indicators and some genera are used as food.

5.10 □ Exercises

Objective multiple choice questions

1. Peristome teeth are found in the genus: a) *Riccia* b) *Anthoceros* c) *Funaria* d) *Marchantia*.
2. Which of the following species of *Riccia* is aquatic? – a) *R. fluitans* b) *R. discolour* c) *R. gangetica* d) *R. crystallina*.
3. *Anthoceros* is commonly known as _____ (Fill in the blank)- a) Stone wort b) Liver wort c) Horn wort d) Bladder wort.
4. Which of the following moss lacks peristome teeth ? a) *Funaria* b) *Sphagnum* c) *Polytrichum* d) *Pogonatum*.
5. In which bryophyte seta is absent in the sporophyte ? a) *Riccia* b) *Marchantia* c) *Porella* d) *Sphagnum*.
6. Columella is the part of : a) Capsule b) seta c) Foot d) rhizome.
7. Which class of bryophytes has multicellular or septate rhizoid? A) Hepaticopsida b) Anthocerotopsida c) Bryopsida d) None of the above.
8. Which of the following bryophytes produces antibiotic?- a) *Barbula* b) *Riccia* c) *Marchantia* d) *Anthoceros*.
9. Which of the following bryophytes is marine? a) *Riccia gangetica* b) *Funaria hygrometrica* c) *Riccia fluitans* d) *Scopania undulata*.
10. What is the term used to denote the leaf of *Funaria*? a) Phylloid b) Cauloid c) Columella d) Paraphyses.
11. Where the entire endothecium is converted into columella? a) *Riccia* b) *Marchantia* c) *Anthoceros* d) *Funaria*.
12. The eleter in *Marchantia* is : a) Haploid b) Diploid c) Triploid d) Polyploid.
13. In which bryophyte the sporophyte has meristematic tissue? a) *Riccia* b) *Marchantia* c) *Anthoceros* d) *Polytrichum*.

14. The number of peristome teeth in *Funaria* is : a) 8 b) 16 c) 32 d) 64.

Answers: 1(c), 2(a), 3(c), 4(b), 5(d), 6(a), 7(c), 8(a), 9(d), 10(a), 11(c), 12(d), 13(c), 14(c) .

Answer the following questions

1. Write the salient features of Bryophytes. (Ans. See section 5.3.1)
2. What is calyptra? (Ans. See section 5.3)
3. What do you mean by exoscopic embryo? (Ans. See section 5.3)
4. Characterise Hepaticopsida. (Ans. See section 5.4)
5. What is meant by nurse cell? (Ans. See section 5.4)
6. What is eleter? State its function. (Ans. See section 5.4)
7. Distinguish between eleter and pseudoleter. (Ans. See section 5.4 & 5.5)
8. Write the salient features of Bryopsida. (Ans. See section 5.6)
9. What are perichaetal leaves? (Ans. See section 5.6)
10. What are peristome teeth? Mention their function. (Ans. See section 5.6)
11. Write a short note on the thallose gametophyte in Bryophyte (Ans. See section 5.7)
12. Describe different types of thallus organization of foliose gametophytes in Bryophyta. (Ans. See section 5.7.1 & 5.7.2)
13. Distinguish between acrocarpous and pleurocarpous moss. (Ans. See section 5.7.2)
14. Write short notes on :
 - a) Role of Bryophyte in plant succession .[Ans. See section 5.8(A)]
 - b) Bog succession.[Ans. See section 5.8(g)]
 - c) Medicinal importance of Bryophytes.[Ans. See section 5.8(i)]
 - d) Role of Bryophytes as pollution indicator. (Ans. See section 5.8(k)]
 - e) Use of Bryophytes as food. [Ans. See section 5.8(j)]

Unit 6 □ Pteridophyta

Structure

- 6.0 Objective
- 6.1 Introduction
- 6.2 General characters of Pteridophyta
- 6.3 Early Land Plant : *Cooksonia*
 - 6.3.1 Description of the plant :
- 6.4 *Rhynia*
 - 6.4.1 Discovery
- 6.5 Ecological role of Pteridophytes
- 6.6 Economic importance of pteridophytes
- 6.7 Summary
- 6.8 Exercises

6.0 □ Objective

Pteridophytes are vascular cryptogamic plants. They flourished in pre historic ages. Majority of extant plants are herbaceous in nature. You will learn about their general characteristics, structure, reproduction and economic importance from this unit.

6.1 □ Introduction

Pteridophytes are land vascular cryptogamic plants which are placed after bryophyte in terms of evolutionary aspects. They are shade loving plants growing in hilly as well as plane areas with high moisture level. They flourished in the prehistoric ages during Devonian and Carboniferous era. Unlike bryophytes the sporophytic stage is dominant in the life cycle. The sporophyte is independent since it is actively assimilatory in nature. The main plant body is sporophyte which is differentiated into root, stem and leaves. The vascular tissue of the sporophyte is made up of xylem and phloem. There is a great diversity in the habit and habitat of the sporophyte. Though majority of sporophytes are herbaceous in nature, *Cyathea spinulosa* is a tree. *Lygodium japonicum* is a climber. Some are epiphyte e.g. *Drynaria*. Even some species are found to grow in saline soil e.g. *Acrosticum aureum*. The species of

Marsilea, *Azolla* etc are aquatic. In India more than 1200 species are found to grow out of which 193 species are endemic. After going through this chapter learners would know the diagnostic features of pteridophytes. They would be able to distinguish these groups of plants from other groups and will be able to identify them. They will be able to recognize the features of land plants of geological ages. Different field of applications of Pteridophyte will be inculcated in their mind.

6.2 □ General characters of Pteridophyta

The salient features by which pteridophytes could be distinguished from other group of plants are as follows:

- (a) The sporophyte is differentiated into root stem and leaves. In some cases rhizoids are present instead of leaves.
- (b) There are two kinds of leaves on the sporophyte and accordingly the sporophyte may be such as microphyllous and megaphyllous. The leaves are sessile. In some cases colourless scale leaves are found (e.g. *Psilotum*). In microphyllous genera the leaves are small, without any leaf traces. These leaves are simple, without any mid vein and these are projected out as a lateral enation (e.g. *Lycopodium*, *Selaginella*). In the megaphyllous genera, leaves are large with distinct mid vein. Prominent leaf trace and leaf gap are present in such leaf. Leaves are compound and the mid vein is branched. (Fig.6.1)

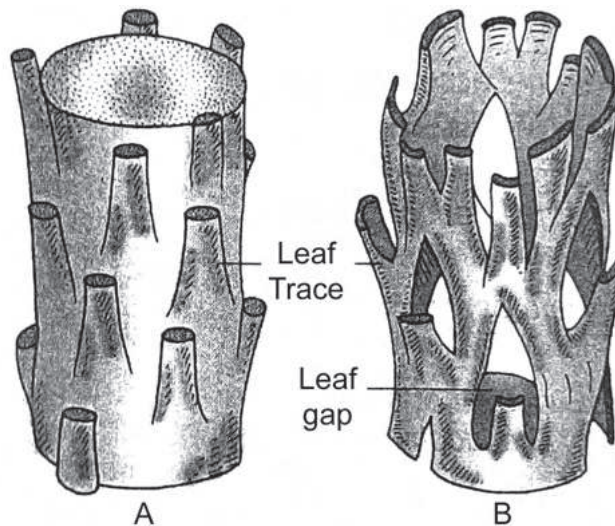

Fig. 6.1. Presence of leaf trace only in microphyllous leaves & Presence of both leaf trace and leaf gap in megaphyllous leaves.

- (c) The axis of the sporophyte is dichotomously branched. Two types of branching patterns are observed such as monopodial and dichotomous.
- (d) The axis of the sporophyte is provided with vascular tissue system. The vascular bundle is made up of xylem and phloem. As cambium is absent in the bundle, so the secondary growth of the stem does not occur (except: *Botrychium*, *Lepidodendron*, *Calamites*).
- (e) The stele or central cylinder of the stem or aerial axis is of two types, such as **protostele** and **siphonostele**. In the former type parenchymatous pith inside the central cylinder is absent and there is a solid xylem core at the centre of the stele. Contrary to this, parenchymatous pith at the centre of the stele is the identifying feature of siphonostele. Variation in the structural organisation of both protostele and siphonostele is observed in different members of pteridophyte. In *Lycopodium*, *Selaginella*, *Psilotum* etc. the stele is of protostelic type whereas in *Botrychium*, *Equisetum* etc. the stele is siphonostelic type. The **dictyostelic** structure of stelar organization is found in *Pteris*, *Polypodium* etc.
- (f) The sporophyte propagates by the production of spores. Spores are of two types, smaller spores are called microspores and the larger spores are called megaspores. The microspores and megaspores are produced in microsporangium and megasporangium respectively. The number of microspores per microsporangium is far larger than the number of megaspores per megasporangium. However, in some members all spores as well as sporangia are of identical type. These members are called **homosporous** (e.g. *Lycopodium*). The members, where two morphologically distinguished types of spores are produced, are called **heterosporous** (e.g. *Selaginella*, *Marsilea*). The microspores germinate to form male gametophyte bearing male sex organ or **antheridia** whereas the megaspore germinates to form female gametophyte bearing female sex organ or **archegonia**. In homosporous members the gametophyte produced as a result of germination of spore bears both male and female sex organs. In *Equisetum* the spores though identical in shape and size but on germination some of them gives rise to male gametophyte and the others give rise to female gametophyte. The phenomenon of such morphologically identical but behaviourally different spore production is termed as **incipient heterospory**. This feature is considered as intermediate evolutionary form between homospory and heterospory. The heterospory in course of evolution gives rise to **seed habit**.
- (g) The antheridia are shortly stalked or stalkless, pear shaped, remain covered with jacket layer. Inside the antheridia androcytes differentiate. Each androcyte gives rise to a motile, uninucleate and flagellate, spermatozoid or antherozoid. Archegonia are flask shaped having a swollen basal end called venter and an elongated neck.

Inside the venter of matured archegonium a single egg is present. The neck of immature archegonium contains neck canal cells which disintegrate upon maturity.

- (h) Like bryophytes, water is essential in Pteridophytes to bring about fertilization. The flagellated spermatozoids reach the cover cells located at the apex of archegonium by swimming and one of them ultimately reaches to the egg after passing through the neck canal of the archegonium to carry out fertilization.
- (i) The sporangium remains associated with a leaf like structure called sporophyll. The microsporangium bearing leaves are called **microsporophylls** and megasporangium bearing leaves are called **megasporephylls**. The microsporophylls and megasporophylls are aggregated to form an organised structure called **strobilus or cone**. In *Ophioglossum* sporangia do not bear any sporophylls and being aggregated to form a specialized structure called **fertile spike**. In *Marsilea*, *Azolla* etc. the micro and mega sporangia are borne inside a sac like structure called **sporocarp**. In some ferns the sporangia are arranged in groups below the sporophyll (e.g. *Dryopteris*) or along the margin of it. Such sporangial aggregates are called **sori** (singular: sorus). When sori are developed continuously in close proximity along the margin of sporophylls, then such type of sorus is termed as **coenosorus** (e.g. *Pteris*). (Fig 6.2)

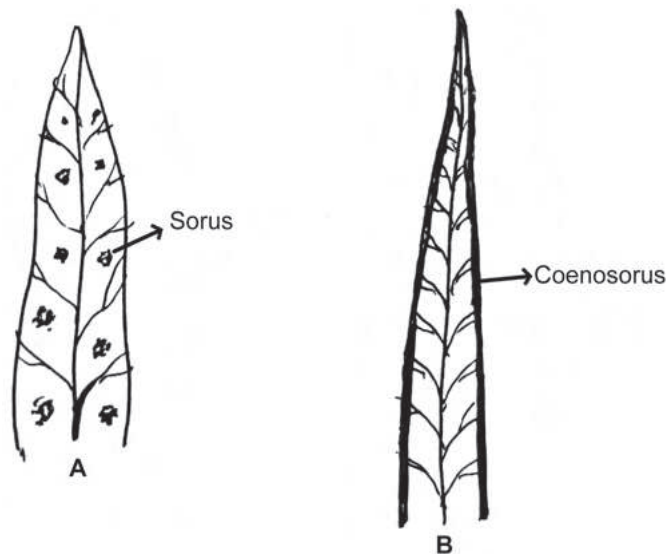

Fig. 6.2 : A. Distribution of sori in megaphyllous leaf of fern, B. Coenosorus.

- (j) On the basis of ontogenic pattern, the sporangial developments are of two types such as: a) Eusporangiate type b) Leptosporangiate type.

Eusporangiate type: In this type of development sporangium originates from a single initial cell. Such initial undergoes transverse division to form an outer and inner cell. Part of the

sporangial wall develops from the outer cell and the remaining part of the sporangial wall develops from the adjacent cell. The inner cell derived from initial cell gives rise to sporogenous tissue. So the sporangial development in this type actually occurs from a group of initials. This kind of sporangial development pattern is known eusporangiate. Example: *Psilotum*, *Lycopodium*, *Selaginella* etc. (Fig 6.3)

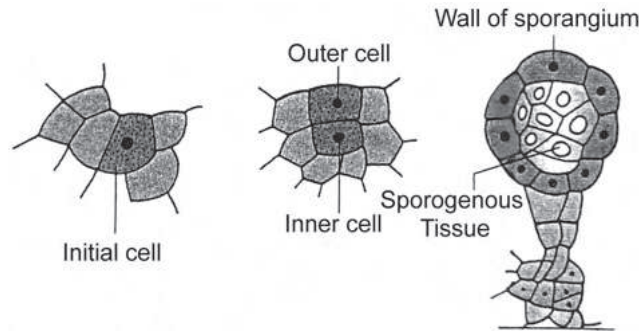

Fig. 6.3 : Eusporangiate type of sporangial development.

Leptosporangiate type: Here also the sporangium develops from a single epidermal cell which divides transversely or obliquely into two cells. Out of these two cells the lower derivative does not take part any more in the formation of sporangium. The whole sporangium entirely differentiates from the outer cell only (Example: *Salvinia*, *Pteris* etc.).(Fig 6.4)

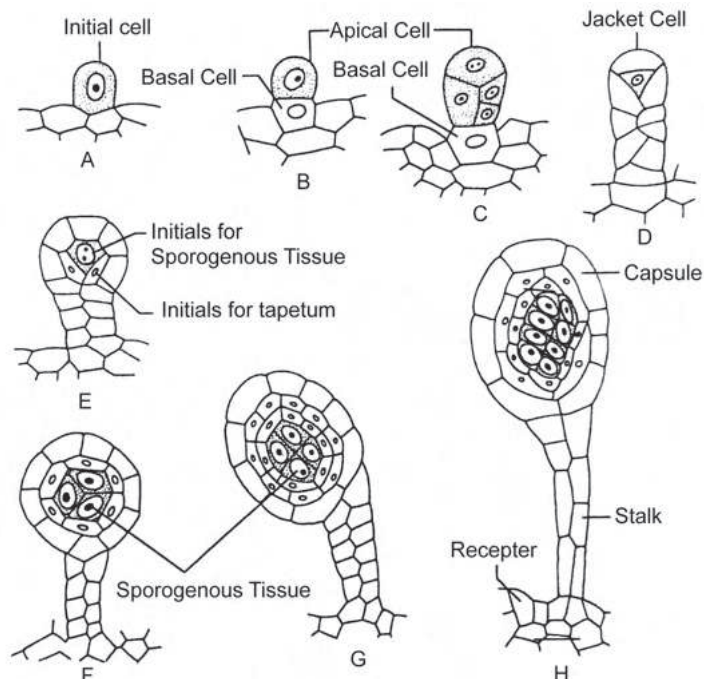

Fig. 6.4 : Leptosporangiate type of sporangial development. (A – H)

- (k) On the basis of the arrangement of the sporangia inside the sorus, three types of sori in pteridophyte have been recognised: (a) The sorus in which all the sporangia originate, grow and mature at the same time, such sorus is called **simple sorus** (Example: *Botrychium*, *Ophioglossum* etc.) (b) **Gradate sorus** : The central sporangia in this type of sorus develops and mature first and the peripheral sporangia mature later (Example :*Marsilea*, *Hymenophyllum* etc.) (c) **Mixed sorus** : In this type of sorus mature and immature sporangia remain mixed together (*Marsilea*, *Hymenophyllum* etc.).(Fig 6.5)

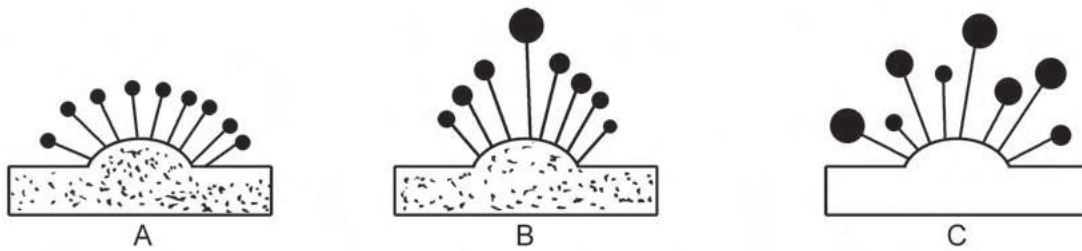

Fig. 6.5 : Different types of sorus in fern. A. Simple sorus, B. Gradate sorus C. Mixed sorus.

- (l) The sporangial wall of fern is made up of two types of cells. Thick walled cells are called **annulus** and thin walled cells are called **stomium**. (Fig 6.6)

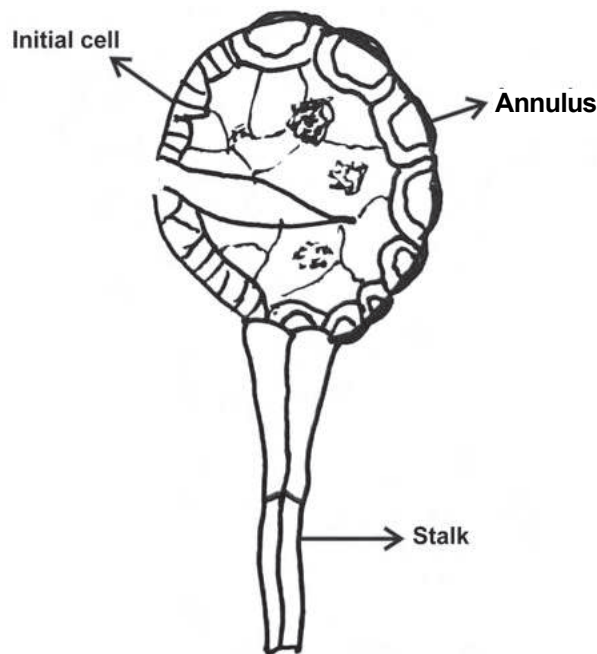

Fig. 6.6 : Structure of a sporangium of fern.

- (m) The spore germinates to produce gametophyte. When development of gametophyte from spore starts when the spore remains inside the sporangium, such gametophyte is called **endosporic type** (Example: *Selaginella*, *Isoetes*). When development of the gametophyte takes place exclusively under external environmental condition after the spore being released from the sporangium, such gametophyte is **exosporic type**.
- (n) Zygote is produced as a result of fertilization which by repeated mitosis forms multicellular embryo. On the basis of the divisional pattern of zygote, embryos are of two types such as: (a) **Exoscopic embryo**: In this type the zygotic division produces two daughter cells, the cell located towards the neck of the archegonium produces shoot of the sporophyte. Example: *Psilotum*, *Equisetum* etc. (b) **Endoscopic embryo**: Here the two daughter cells produced as a result of zygotic division remain arranged in such a manner that the lower most one that is the cell located towards ventre gives rise to the shoot. This type of embryo is found in the genus like *Lycopodium*, *Selaginella*, *Isoetes* etc.
- (o) The alternation of generation in pteridophytes is heteromorphic type which means that the gametophytic and sporophytic stages are morphologically different. The life cycle pattern in homosporous and heterosporous forms is given in the Unit IV (Archegoniate).

6.3 □ Early Land Plant: *Cooksonia*

Discovery: It is the first land vascular plant on earth which was initially discovered in the year 1937. The fossil remains of this plant in majority have been discovered from Britain. This plant was distributed on different places earth from 433 to 393 million years ago during middle of the Silurian to early Devonian. William Henry Lang first described this plant and the plant was named after Isabel Cookson who was the co-worker of Lang. The fossil plant was placed under the division Rhynophyta by Gifford and Foster (1989).

6.3.1 Description of the plant

The sporophyte of the plant has been described on the basis of fossil records. The plant is simple in its structural organisation and attains only few centimetres in length. *Cooksonia* is considered intermediate between bryophyte and terrestrial land plants. The plant body was rootless, leafless, and simple in its organization and assumed to have

emerged from a horizontally grown rhizomatous axis. The evidence of latter is absent due to lack of preservation. The aerial axis was cylindrical dichotomously branched and bears terminal sporangia. The sporangia are flat, more or less disc like, bear spores of identical shape and size within. The growth of the aerial axis has been terminated by the development of sporangia. **(Fig6.7)**

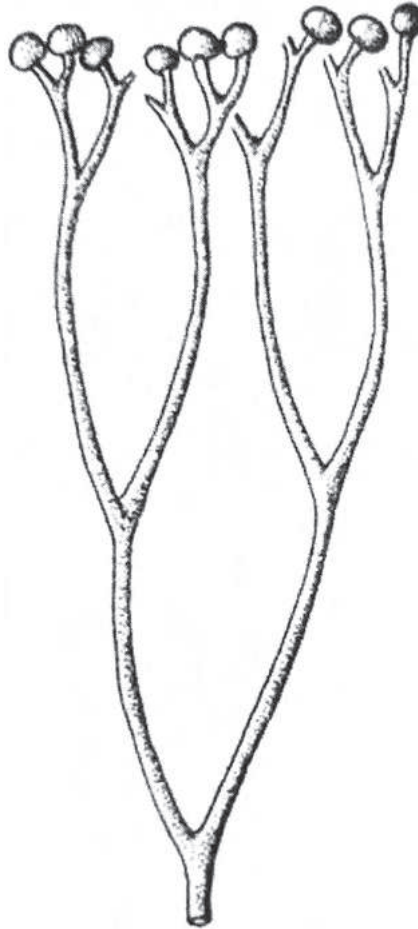

Fig. 6.7 : *Cooksonia caledonica*

The diameter of stem in *Cooksonia* may vary according to the species. The breadth of the stem may vary from 0.03 mm to 3.0 mm depending upon the species. Great diversity in shape and size of spores and sporangia are also observed. A central granular dark region is found in some preservation at the centre of the stem along the length of the aerial axis which is assumed as water conducting vascular tissue. In some specimen stomata are observed on stem surface. The greater number of stomata indicates apical end of the stem.

It is assumed that the stomata plays role in gaseous exchange and transpiration driven water transport in the stem. In some specimens hemispherical outgrowth is present at the basal end of the stem which contains assimilatory tissue and stomatal aggregates at the epidermal region. Such outgrowth is considered as homologous to the apophysis of mosses.

According to Gonez and Gerrienne (2001) the sporangia are trumpet shaped and characterized by the presence of a terminal cap like structure called operculum. The operculum disintegrates on maturity and helps in the release of spores from sporangia. According to Gonez et al *Cooksonia* probably had six species. The species like *Cooksonia pertoni*, *C. Paranensis* and *C. banksii* are similar in respect of the sporangial structure. All these species have trumpet shaped sporangia. The stem of *C. Paranensis* is to some extent thinner than *C. partoni*. The stem of *C. bohémica* is very sturdy and branched. Due to lack of preservation the structure of spornagia here is not so prominent. This species has been discovered from the same bed from which *C. hemispherica* was discovered. The shape of the sprorangia in *C. hemispherica* is however hemispherical. In *C. cambrensis* the shape of the sporangium is spherical.

6.4 □ *Rhynia*

6.4.1 Discovery

Two scientists Kidston and Lang first discovered this fossil plant from Rhynie chert bed of Scotland in the year 1917. The plant was distributed luxuriantly during Middle Devonian (Pragian stage, around 410 million years ago). The plant body was very simple and primitive, without having any root and leaves. There are two systems in plant body, such as horizontally growing subterranean rhizomatous axis and vertically elongated aerial axis. The aerial axes are dichotomously branched and bear sporangia at the apex of it.

The species that was discovered by Kidston and Lang in 1917 was *R. gwynne-vaughnii*. In 1920 they segregated the genus into two different species such as *R. gwynne-vaughnii* and *R. major*. A new concept on *R. major* was introduced by D.S. Edward in 1986. He observed that there is no thickening in the xylem of the stem of this species. So he changed the name of the genus of this species as *Aglaophyton major*. In the year 1980, Remy and Remy (1980) discovered the male gametophyte of this species and named it as *Lynophyton rhyniensis*. The comparative account of these two species is described below:

<i>Rhynia gwynne-vaughanii</i>	<i>Rhynia major</i>
<p>External morphology of the aerial axis: The diameter of the aerial axis is about 3.0 mm and it attains a height of about 20mm. The aerial axis is cylindrical gradually become tapering towards the apex. In the aerial axis dichotomous, monopodial or adventitious branching pattern is observed. Aerial axis bears stomata. Stomata remain covered by two spherical guard cells. The presence of stomata indicates assimilatory nature of the stem. Just below the stomata of the aerial axis some hemispherical outgrowths are usually found which contain fungal infected necrotic tissue inside.</p> <p>Internal morphology of the aerial axis: The cortex of the stem is internally differentiated into outer and inner cortex. The outer cortex is made up of homogeneous densely arranged, elongated cells. The inner cortex is made up of isodiametric parenchymatous cells with intercellular space. Evidence of VAM (Vesicular arbuscular mycorrhiza) infection is found in this region. The outer and inner cortex is found to remain delimited by some brown coloured objects which are without of any definite shape and size. The stele is protostele having a central solid xylem core surrounded by a phloem layer; Xylem strand is terete and endarch. The cells of the xylem is characterised by having spiral or annular thickening.</p>	<p>External morphology of the aerial axis: Though this species is morphologically identical with <i>R. gwynne-vaughanii</i>, still some differences are there. The diameter of the aerial axis of this species may attain upto 6.0mm. The height of the aerial axis is also greater than <i>R. gwynne-vaughanii</i> and it may attain height upto 15cm-50 cm. The aerial axis is dichotomously branched and the branching occurs at a comparatively wide angle of upto 90° and bears some adventitious branches on it. The stem is round, smooth, unornamented.</p> <p>Internal morphology of the aerial axis: The epidermis of the stem is plain and remains covered with thick cuticle. The stem surface bears stomata. The latter remain associated with two kidney shaped guard cells. The cortex of the stem is differentiated into outer and inner cortex. <i>Aglaophyton</i> is among the first plants known to have had a mycorrhizal relationship with fungi, which formed arbuscules in a well defined zone in the cortex of its stems. The stem shows typical protostelic organization. There is a central xylem core surrounding which phloem layer is present. Xylem is terete and endarch. Xylem lacks any secondary thickening bars which is more like that of the water conducting system of mosses (hydromel).</p>

Reproductive structure: The sporangia are borne singly on the apices of some aerial branches. Each sporangium is oval or slightly cylindrical structure with a little greater diameter than that of the aerial branch on which it is developed (4 mm long and 1mm broad). Spores are isospores. **(Fig 6.8)**

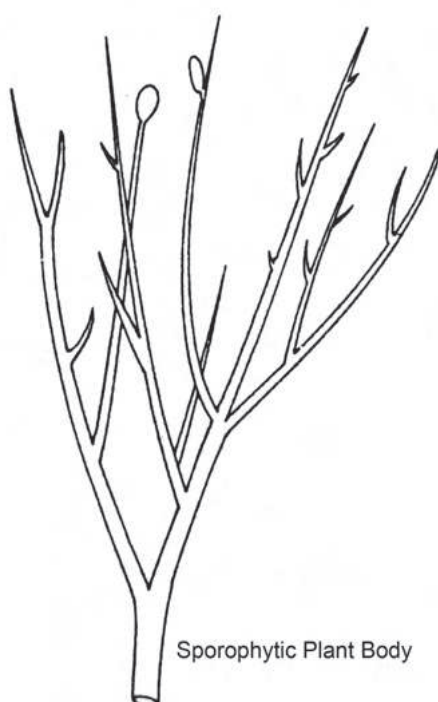

Fig. 6.8 : Sporophyte of *Rhynia gwynne-vaughanii*.

Reproductive structure: The aerial branches are terminated with elliptical thick walled paired sporangia (12 mm long and 4 mm in breadth), which when mature, open through spiral slits, so the sporangia appear to be spiral in form. Spores are isospores bearing trilete marks. **(Fig 6.9)**

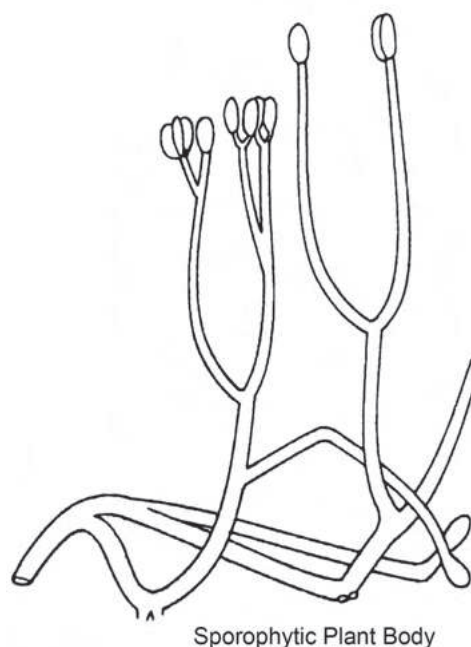

Fig. 6.9 : Sporophyte of *Rhynia major*

6.5 □ Ecological role of Pteridophytes

Pteridophytes have the following ecological role :

- a) **Role of Pteridophyte as ecological indicator (EI):** Pteridophytes play important role as ecological indicator by their existence in a particular ecological

environment, their sensitivity to different ecological factors and their diversity as well as species richness. Pteridophytes serve as the indicator of the following parameters of the ecosystem:

- (i) **Classification of soils , vegetation and ecosystem** : There is a strict correlation between the species specific occurrence and distribution of pteridophytes with the type of soil, vegetation and ecosystem. Through extensive survey of such species specific distribution and occurrence, it could be possible to predict the nature of soil, vegetation and ecosystem of a particular area.
- (ii) **Environmental integrity**: In forest ecosystem two important factors such as reduction of solar irradiation and high level of humidity influence the species richness and abundance of Pteridophytes. If such two important parameters are altered due to some anthropogenic factors, it will reduce the density of pteridophyte population. On the contrary, well preserved habitat in forest ecosystem is correlated with high species diversity and richness of pteridophytes. Thus high species diversity and richness of the population of the pteridophyte serves as an indicator of environmental integrity.
- (iii) **Disturbances**: Disturbances of a given natural area generally promotes at first the simplification of its community structure. This is usually reflected by reduction of species richness and diversity of pteridophytes and other species. As pteridophytes are more sensitive to ecological disturbances, their population reduction in a particular area could be recognised easily in comparison to other group of plants. Thus it serves as an indicator of ecological disturbances of that area.
- (iv) **Regeneration and restoration of habitat**: Pteridophytes serve as indicator for regeneration and restoration of habitat. The areas where vegetation loss occurs due to natural calamities like fire, frost etc., in such areas appearance of the pteridophyte is indicative of natural restoration. Thus pteridophytes serve as first regenerated vegetation in an area where there was a loss of any previous vegetation.
- (v) **Climate changes**: Expansion and retraction of climate sensitive pteridophytes indicate the climate changes of a particular area. Sensitive pteridophytes can be considered as good ecological indicators for monitoring such temporal and spatial changes.

- (vi) **Contamination of air soil and water:** Pteridophytes serve as indicator of contamination of heavy metals (like arsenic, lead, antimony, chromium, gold etc) in aquatic and terrestrial ecosystem. Some species of pteridophytes are hyperaccumulator of different such contaminants and increase of the contaminants beyond the tolerance level may cause their foliar and other internal tissue injury. The level of contamination thus could be measured by the concentration of accumulated contaminants in the tissue of such indicator species of pteridophyte.

The sensitive species however become eliminated from the growing site due to such contamination and such elimination could also serve as good indicator. Many species of genera like *Blechnum*, *Pteridium*, *Elaphoglossum* etc have been reported to serve as good indicator of different pollutants and heavy metals. *Equisetum arvense* serves as gold indicator and that is why the plant is commonly known as 'Goldrush'. This species acts as hyper accumulator of gold. The dense growth of this species in a particular area indicates the existence of the ores of gold. It has been observed that 4.5 ounce of gold could be stored by one ton of the sporophyte of *Equisetum*.

- (vii) **Association with other groups of organisms:** Pteridophytes can be employed to indicate the presence of other species in a given site. Pteridophytes provide unique ecosystem that facilitates colonization and association of other species with them. In case of the pteridophytes grow in association with other species, the growth of that particular species of pteridophyte indicates the obvious existence of other, such species are called **keystone species** (e.g. tree fern, litter basket fern etc.). Thus a particular taxon may be utilized for estimation of the diversity of other associated taxa or taxon in a particular habitat or a set of habitats.
- (b) **Role of Pteridophyte in nitrogen fixation:** Among pteridophytes the fern *Azolla* is ecologically important since it adds nitrogen to the soil from atmosphere. The fixation of nitrogen by *Azolla* is indirect. Blue green alga named *Anabaena azollae* lives endophytically in *Azolla* plant and fix atmospheric nitrogen. The alga contains heterocyst within which nitrogen fixing enzyme nitrogenase is present in oxygen protected state and cause nitrogen reduction. So growth of *Azolla* in agricultural field is beneficial for the supply of nitrogen to crop plants. Fixed nitrogen passes through food chain into the body of different animals including human beings. The growth of *Azolla* in agricultural field not only adds nitrogen to the field but also it acts as bio herbicide. The thick growth of the sporophyte

on the surface of water forms a mat like covering that prevents penetration of sunlight at the bottom of the field. Thus the seed of the weeds cannot grow in absence of light. The growth of *Azolla* also reduces the temperature of the stagnant water in the rice field which also adversely affects the germination of seeds of different weeds. Thus *Azolla* plays ecological role in the regulation of nitrogen cycle through mobilization of nitrogen from atmosphere into the food chains.

- (c) **Role of pteridophyte to provide microhabitat:** Pteridophytes provide shelter and shade to smaller plants and animals. Some ground vegetation prefers to grow under the shade and moist environment provided by pteridophytes. Pteridophytes also harbour different microorganisms and small animals in them. Thus this group of plants has immense role in maintaining flora and faunal diversity.
- (d) **Role of pteridophytes in succession:** Plant succession is a process by which a nonlife habitat is converted into stable forest vegetation after passing through multiple stages. Each stage is known as a sere. One seral stage is replaced by the other and the process is continued until a stable or climax vegetation is attained. Such seral stage may be constituted and dominated by the pteridophytes. The death and decomposition of the plant body of pteridophytes of a seral community changes the substratum in such a way that it becomes helpful for further colonization of different herbaceous plant community. In this way pteridophytes regulate ecological succession.

Role of pteridophytes in prevention of soil erosion: The rhizomatous stem and the adventitious roots emerged out of it hold the soil particles tightly and prevent soil erosion. The pteridophytes growing on the slopes of hill prevent erosion of soil effectively by acting as soil binder.

Agricultural role of Pteridophytes: Pteridophytes could be exploited to convert a salt contaminated sterile land into a fertile cultivable land. *Acrosticum aureum* is a salt tolerant pteridophyte that can grow in saline soil and accumulate salt in its body after absorption. Such plant is cultivated in land which attains high salt concentration due to inundation by sea water. The repeated cultivation of the plant removes high salt concentration from such salt contaminated land. Thus pteridophytes play vital role in soil reclamation.

6.6 □ Economic importance of pteridophytes

Pteridophytes have high economic values. These plants could be used as food, fodder, medicines. Some species have aesthetic value. The economic importance of pteridophytes is described below:

- A) Use of pteridophyte as food:** The rhizome, immature frond, shoot etc. of many ferns are used as food. The tribal people of hilly region use underground rhizome and immature frond of *Asplenium* as their food. In Malaysia the rhizome of *Blechnum orientalis* is used as food. The immature frond of *Ceratopteris thalictroides* is used as vegetables. Similarly, the immature frond of *Diplazium esculentum* is eaten directly by mixing it with salad. The shoot tip as well as rhizome of *Nephrolepis biserrata* is also edible. Different species of *Angiopteris* are taken in India as an enriched source of starch. Arrowroot like substance is produced from the rhizome of *Pteris* in China. In Philippines the leaves and rhizomes of two species such as *Pteris ensiformis* and *Helminthostachys zeylanica* are eaten after boiling. In the same country, the immature leaves of two species such as *Phymatosorus longissimus* and *Microsorium alternifolium* are also taken as food. A type of starch is extracted from the sporocarp of *Marselia drumondii* which is used to make a type of cake called 'nardoo' by the tribes of Australia. *Matteuccia struthiopteris* serves as a common spring vegetable in Canada and America.
- B) Medicinal importance of pteridophytes:** Pteridophytes play immense role in curing various types of ailments or diseases. Different species of the genus *Lycopodium* have immense medicinal values. It is used in the preparation of homoeopathic medicine. *L. inundatum* produces fixed oil which is used as an important component of different medicine. The extract of *L. clavatum* is used as kidney stimulant. The extract of *Dryopteris filix-mas* is used to treat tapeworm infection. A medicine obtained from *Selaginella botryoides* is used to cure liver ailments. *Equisetum arvense* has been described as "Herba Equiseti" in the German Pharmacopia. This species has diuretic property. The ash obtained from this species is used to cure acidity and other digestive ailments. The medicine obtained from *E. debile* is used to cure gonorrhoea. Besides, many other important species of pteridophytes are used to cure different diseases as described below in the tabular form:

Scientific name	Parts used	Applied for curing of the diseases.
1. <i>Adiantum capillus-veneris</i> L.	Leaves	Cough and throat infection
2. <i>Actinopteris radiata</i> L.	Whole plant	Anthelmintic property and used to treat menstrual disorder.
3. <i>Acrosticum aureum</i> L.	Rhizome	Healing of wounds
4. <i>Asplenium falcatum</i>	Whole plant	Jaundice, malaria, enlargement of spleen.
5. <i>Botrychium lunaria</i> L.	Leaves and roots	Amoebiasis
6. <i>Cephalomanes javanicum</i> (Bl)	whole plant(Dried)	Headache
7. <i>Ceterach officinarum</i> Willd.	Whole plant	Diuretic, coagulation of blood
8. <i>Cheilanthes farinosa</i> Kaulf.	Roots	Stomach ache, skin diseases
9. <i>Cibotium barometz</i> L.	Roots	Relief in cervical pain
10. <i>Marselia minuta</i> L.	Leaves	Epilepsy
11. <i>Helminthostachys zeylanica</i> L.	Whole plant	Treatment of scitica
12. <i>Hemionitis arifolia</i> (Burn)	Leaf extract	Curing burning lesion
13. <i>Lemmaphyllum carnosum</i> L.	Leaves	Stone of urinary bladder and rheumatism
14. <i>Lygodium flexuosum</i> L.	Leaves	Ulcer, skin diseases and healing of wounds.
15. <i>Lygodium japonicum</i> L.	Leaves	Medicine for cough.
16. <i>Nephrolepis cordifolia</i> L.	Fronde	Cough relief
17. <i>Ophioglossum pendulum</i>	Leaves	Hair growth stimulant

Reference: Ethnobotanical Leaflets 12:281-285 (2008); A review on the potential uses of ferns by Mannam, M.M., Maridas, M. & Victor, B.

- C) Insecticidal properties of fern:** Different species of fern could be exploited to control harmful insects and pests. Filicin obtained from *Dryopteris flix mas* is an example of such compound which has insecticidal property. The anihelminthic property of the same compound has also been reported. **Phytoecdysones**

obtained from the fern leaves prevent the development of insect larvae. Ferns prevent themselves from insect attack by production of this compound. The crude extract of leaf of ferns has been proven to have toxic activity against the insects like *Spodoptera littura* and *Helocoverpa armigera*. The leaves of *Phymatosorus scolopendria* are kept under the bed to prevent bugs.

- D) Uses of fern as ornamental plant:** Different species of fern are used as ornamental plant. *Psilotum* is commonly known as Whisk fern which is used in green house for decoration. *Lycopodium volubile* is used in table decoration. *L. obscurum* is commonly known as Christmas green. This species used in Christmas decoration. Some epiphytic species of *Lycopodium* is commonly known as hanging basket. This plant is also used in decorating rooms. *Selaginella serpens* can change the colour of its leaves periodically and due to this reason such species is used as ornamental plant. Different species of *Drynaria* is grown in tub and used in indoor decoration. *Pteris vittata* and *Adiantum sp* is cultivated as ornamental plant in garden. Due to the characteristic properties possessed by *Pityrogramma chrysophylla* (commonly known as golden fern) and *Hemionitis arifolia* (Rabbit ear fern) is cultivated in the garden as ornamental plant.
- E) Use of fern as fodder:** Different pteridophytes are used as animal feed. The corm of *Isoetes* is used as food of the domestic animals like duck, rat, pig etc. Animal feed mixed with *Azolla* increases cow milk production. Different species of *Marsilea* is used as feed for domestic animal.
- F) Use of pteridophyte as green manure:** *Azolla* is used as biofertilizer since its growth in rice field increases crop productivity by adding atmospheric nitrogen to the soil. The endophytic alga *Anabaena azollae* lives inside the frond of *Azolla* and perform this function by its heterocyst. It has been proved that 30-38% rice production could be increased by using *Azolla* as biofertilizer in rice field. The reasons behind the increase in productivity by application of *Azolla* are as follows: (a) The thick layer of growth of the plant on the water surface prevents penetration of sunlight at the bottom and thereby inhibits germination of seeds of weed. So weeds could not propagate in presence of *Azolla* in rice field.
- (b) The growth of *Azolla* reduces water temperature to some extent and depresses the germination of weeds.

- (c) Nutrients in flood water can not directly be absorbed by rice plant. *Azolla* can accumulate nutrients from flood water and provide these after *Azolla*'s decomposition.
- (d) Under the mat of *Azolla* the floodwater pH does not turn alkaline which prevents alkaline reactions that reduce ammonia loss.

At present *Azolla*-rice-duck integrated cultivation approach is being followed in foreign countries like Japan. *Azolla* increases fertility by adding nitrogen to the soil. On the other hand the ducklings during roaming in the rice field take some young leaves of *Azolla* plant and insects or rice plant. Both of which are helpful for the growth of duckling by serving as protein source. Moreover, *Azolla* prevents the growth of weeds. Duck on the other hand contributed to *Azolla* by eradicating *Azolla* insect pest, and spreading *Azolla* by its movement. Ducks' excreta may supply phosphorus to *Azolla*. This rice- duck - azolla system is now being adopted by organic farming farmers.

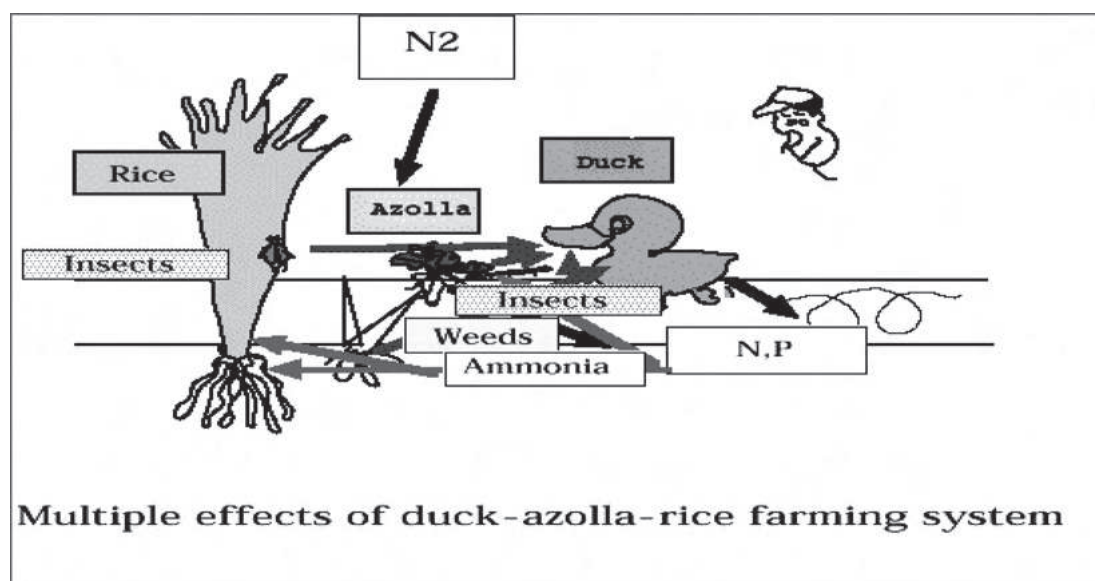

- G) Use of pteridophyte as a polishing material:** The vegetative body of the sporophyte of different species of *Equisetum* (e.g. *E. Hyemale*) being rich in silica, it is used as polishing material of furniture and utensils.
- H) Use of pteridophyte as beverage:** A tea like extract is obtained on boiling the dried sporophyte of *Dryopteris fragrans* which is taken as stimulating beverage by the tribal people of Europe.

6.7 □ Summary

Pteridophytes are differentiated into roots, stem and leaves. They have well developed xylem and phloem some members are homosporous while others are heterosporous with plant bodies producing morphologically two different kinds of spores. Sporangia are two types – Eusporangiate and heptosporangiate. Early land plants like *Cooksonia* and *Rhynia* have distinctive structural features and produce isospores. They have significant ecological importance.

6.8 □ Exercises

Objective multiple choice questions

1. Which of the following species of pteridophyte is known as ‘Goldrush’- a) *Lycopodium clavatum* b) *Selaginella repunda* c) *Psilotum nudum* d) *Equisetum debile*.
2. Which of the following pteridophyte is known as Maiden hair fern? a) *Fucus* b) *Adiantum* c) *Dryopteris* d) *Pteris*.
3. The name of the heterosporous fern is –a) *Lycopodium* b) *Dryopteris* c) *Marselia* d) *Equisetum*.
4. Which of the following ferns is used as biofertilizer? A) *Anabaena* b) *Nostoc* c) *Marselia* d) *Azolla*.
5. Ligule is found in a) *Selaginella* b) *Marselia* c) *Equisetum* d) *Pogonatum*.
6. Which pteridophyte is known as resurrection plant ? a) *Equisetum* b) *Selaginella* c) *Marselia* d) *Psilotum*.
7. Name the pteridophyte where vascular tissue is found in the gametophyte. a) *Azolla* b) *Selaginella* c) *Psilotum* d) *Marselia*.
8. Which one is a rootless and leafless pteridophyte? a) *Equisetum* b) *Selaginella* c) *Psilotum* d) *Lycopodium*.
9. Which of the following is known as tree fern? a) *Cyathea* b) *Marselia* c) *Lycopodium* d) *Equisetum*.

10. Name one pteridophyte that grows in saline soil. a) *Lygodium japonicum* b) *Ophioglossum reticulatum* c) *Acrosticum aureum* d) *Psilotum nudum*.
11. Sporocarp is found in which of the following genera ? a) *Dryopteris* b) *Lycopodium* c) *Marselia* d) *Selaginella*.
12. Where incipient heterospory is found ? a) *Selaginella* b) *Equisetum* c) *Dryopteris* d) *Lycopodium*.
13. An edible aquatic fern is – a) *Selaginella* b) *Marselia quadrifolia* c) *Calamites* d) *Dryopteris flix-mas*.
14. Which of the following types of leaves lack leaf gap? a) Megaphyllous leaf b) Microphyllous leaf c) Isophyllous leaf d) Mega and isophyllous leaf.
15. Which pteridophyte has elater? a) *Psilotum* b) *Lycopodium* c) *Equisetum* d) *Dryopteris*.

Answers: 1(d), 2(b), 3(c), 4(d), 5(a), 6(b), 7(c), 8(c), 9(a), 10(c), 11(c), 12(b), 13(b), 14(b), 15(c).

Answer the following questions

1. Classify pteridophytes on the basis of ontogenetic pattern of sporangial development.
2. What is meant by coenosorus? (Ans. See the general characters of pteridophyte)
3. Distinguish between: a) Microphyllous and Megaphyllous Pteridophytes (Ans. See the general characters of pteridophyte)
 - a) Exosporic gametophyte and endosporic gametophyte. (Ans. See the general characters of pteridophyte)
 - b) Eusporangiate fern and Leptosporangiate fern. (Ans. See the general characters of pteridophyte)
 - c) Exoscopic and endoscopic embryo. (Ans. See the general characters of pteridophyte)
4. Write a brief note on the soral types in pteridophytes. (Ans. See the general characters of pteridophyte)
5. What are the characters of fern sporangium? (Ans. See the general characters of pteridophyte)

6. Mention the Geological occurrence of *Cooksonia*. (Ans. See section 6.3)
7. Describe the *Cooksonia* plant with diagram. (Ans. See section 6.3.1)
8. Give a comparative account on the morphology of *Rhynia gwynne-vaughani* and *R. major*. (Ans. See section 6.4.1)
9. Why *Rhynia major* was renamed as *Aglaophyton major*. (Ans. See section 6.4.1)
10. Mention the geological occurrence of *Rhynia* plant. (Ans. See section 6.4.1)
11. How pteridophytes serve as ecological indicator? (Ans. See section 6.5)
12. Write short notes on :
 - (a) Role of pteridophyte in plant succession. [Ans. See section 6.5(d)]
 - (b) Use of Pteridophyte as food. [Ans. See section 6.6(A)]
 - (c) Medicinal importance of Pteridophyte. [Ans. See section 6.6(B)]
 - (d) Insecticidal property of fern. [Ans. See section 6.6(C)]
 - (e) Use of pteridophyte in green manure. [Ans. See section 6.6(F)]
 - (f) Used of fern as ornamental plant. [Ans. See section 6.6(D)]

Unit 7 □ **Gymnosperm**

Structure

- 7.0 Objectives**
- 7.1 Introduction**
- 7.2 Geological occurrence and evolutionary origin**
- 7.3 habit and habitat of Gymnosperms**
- 7.4 General characters of Gymnosperms**
- 7.5 Cycas**
 - 7.5.1 External morphology**
 - 7.5.2 Anatomical structure of stem**
 - 7.5.3 Anatomy of leaf**
 - 7.5.4 Anatomy of root**
 - 7.5.5 Reproduction of *Cycas***
- 7.6 *Pinus***
 - 7.6.1 External features**
 - 7.6.2 Internal morphological features of *Pinus***
 - 7.6.3 Reproductive structure**
- 7.7 Economic and ecological importance of Gymnosperms**
- 7.8 Summary**
- 7.9 Exercises**

7.0 □ **Objectives**

After going through this unit the learners will be able to understand the diagnostic features of gymnosperms by which this group of plants could be separated from other groups. They could recognise these plants growing in natural habitat. They will also be able to describe the vegetative and reproductive characters of these groups of plants and their economic importance.

7.1 □ Introduction

The word ‘Gymnosperm’ was first used by Theophrastus in 300B.C. in his book “Enquiry into Plants”. The word Gymnosperm is made up of two separate words such as *Gymnos* means naked and *sperma* means seeds. So, Gymnosperms are naked seeded plants whose seeds or ovules are not hidden or protected by ovary and be fertilized in open or exposed condition. These plants belong to an evolved group higher in rank than pteridophytes.

7.2 □ Geological occurrence and evolutionary origin

Fossil records reveal that gymnosperms originated on earth during Palaeozoic era approximately before 350 million years ago. They flourished with diversified characters from Upper Devonian period to present though some species have become extinct. However, their luxuriant growth occurred during Mesozoic era. Jeffery opined that gymnosperms have evolved from an advance pteridophyte belonging to the genus *Trimerophyton*. He suggested that *Trimerophyton* gave rise to **Pteridosperms** which are considered as primitive gymnosperms which have fronds like pteridophytes and seeds or ovules with primitive characters. Such primitive successors of *Trimerophyton* are also known as **seed ferns**. The seeds or ovules having primitive characters are called **preovules**. Later on, a separate order Pteridospermales for the pteridosperms or **seed ferns** has been created. The pteridosperms are considered as the progenitor of modern gymnosperms. A new concept came up after the discovery of *Archaeopteris*. The plant bears gymnospermous wood anatomy and pteridophytean reproductive structure and was placed in a separate group called **Progymnosperm**. On the basis of geological occurrence and evolutionary features possessed by them progymnosperms should occupy the position inbetween *Trimerophyton* and pteridosperms. Thus the evolutionary origin of gymnosperms could be presented as follows:

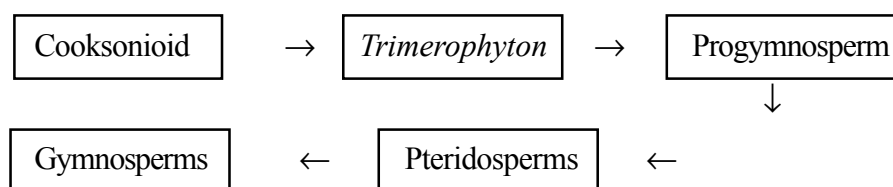

7.3 □ Habit and habitat of Gymnosperms

Most of the Gymnosperms are woody though some may be herbaceous or woody climbers. Some species of *Ephedra* that belong to the family Ephedraceae are herbaceous climbers (e.g. *E. gerardiana*). *E. foliata*, belongs to the same family is an example woody climber which possesses some xerophytic features. *Gnetum ula* belongs to the family Gnetales is another climber. The extant gymnosperms have been categorised into four major orders such as Cycadales, Ginkgoales, Coniferales and Gnetales, among which some of the living members of Cycadales and Ginkgoales are existing on the earth with retaining all primitive features possessed by their extinct predecessors. Therefore, such representatives are called living fossils. *Ginkgo biloba* is a good example of living fossil and it belongs to the order Ginkgoales which was originated during Mesozoic era and surviving on the earth with all its primitive features. Similarly, the members of Cycadales were originated during Mesozoic era and at present they are represented by nine genera distributed in tropical and subtropical region of the world. According to Sanjappa, in India, there are 48 species of gymnosperms which belong to 15 genera and 8 families. Among 48 species 10 are endemic and 26 are exotic and remaining is indigenous.

The members of Coniferales are mostly woody tree and commonly known as Conifers. They have formed dense evergreen forest in both northern and southern hemisphere. *Sequoia gigantea* is the largest gymnosperm belongs to this order which can remain alive more than 4000 years. The other economically important common genera of this order are *Pinus*, *Cedrus*, *Abies*, *Juniperus*, *Thuja* etc.

There are three living genera in the order Gnetales such as *Gnetum*, *Ephedra* and *Welwitschia*. Among them, the last one is monotypic. Only one species of the genus is found to grow in the desert area of South –West Africa. The name of this species is *W. mirabilis*. There are all together 22 monotypic genera in gymnosperms. The highest number of monotypic genera is found in the family Taxodiaceae and Cupressaceae. The genus *Gnetum* has 40 species and the genus *Ephedra* also has 30-40 species both of which are found to grow in tropical and temperate zone of the world such as Asia, Africa and South America etc. The genus *Welwitschia* is unique because it has underground stem of 1.2 m in diameter and only two oppositely arranged leaves are found in matured plant. Only three pairs of leaves are produced by the plant in its whole life span. The first pair is called cotyledonary leaves which are deciduous. The second pair is then emerged which are

persistent. The third and final pair of opposite leaves emerge only after the apical meristem ceases its activity. This final pair of leaf forms a scaly body at the apex of the stem.

7.4 □ General characters of Gymnosperms

- (1) The plant body is sporophyte, differentiated into root, stem and leaves. Usually tree in habit but some species are herbs or shrubs.
- (2) Sporophytes possess tap root system. In some genera mycorrhizal roots are found (e.g. *Pinus*). In *Cycas* roots with endogenously growing algae and they appear like coral. Such roots are called coralloid root.
- (3) The aerial stem is usually straight, branched or unbranched. In *Welwitschia*, the stem is subterranean or underground. Two types of branches such as long and dwarf shoots are found in the genera like *Pinus*, *Ginkgo*, *Larix* etc. Bunch of leaves are produced at the apex of the dwarf shoot.
- (4) The leaves in gymnosperm may be microphyllous or megaphyllous type. The leaves are simple or compound, evergreen, with parallel or reticulate venation. The immature leaves show circinate type of vernation. In majority of the members resin passages are found in the leaf. In Gnetales latex ducts are found in place of resin passage. The stomata in the leaves are sunken and may be of haplocheilic or syndetocheilic type.
- (6) The secondary woods in gymnosperm may be manoxylic or pycnoxylic type. In case of the former, the wood is characterised by the presence of broad medullary rays. Besides, the manoxylic woods are soft, porous, more parenchymatous, light in weight and are of less economic value. A single permanent layer of cambium is present in this type of wood. This kind of wood is characteristically present in the members of Cycadophyta. The pycnoxylic wood on the other hand is hard, heavy, less parenchymatous and with narrow medullary rays. Such characters of the wood add more economic value. In polyxylic wood, however, the cambium is present in multiple layers that lead to the formation of secondary xylem in a concentric manner. In gymnosperms the xylem characteristically lacks vessels and phloem lacks companion cells. The tracheids of the secondary wood contain bordered pit.

- (7) Gymnosperms are heterosporous, that means, two kinds of spores such as small microspores and large megaspores are produced. Microspores are produced in microsporangia and megaspores are produced inside the ovule. Microsporangia and ovules remain associated with leaves called microsporophylls and megasporophylls respectively. The sporophylls remain aggregated on an axis and form a structure called strobilus. Microspores produce male gametophyte whereas megaspores produce female gametophyte. The female gametophyte bears archegonia and never gets released from megaspore or ovule. The development of male gametophyte starts when microspores remain inside the microsporangia. Thus the development of gametophyte is endosporic type.
- (8) The ovules of gymnosperms are exposed, stalkless, and large. Largest ovule is found in *Cycas*. Each ovule remains covered by a single integument, differentiated into three layers; outer fleshy sarcotesta, middle stony sclerotesta and inner fleshy endotesta. Inside the integument nucellus tissue is present within which megaspore mother cell differentiates towards the micropylar end.
- (9) The megaspore mother cell undergoes meiosis and forms four daughter cells, out of which the lowermost one is functional and remaining three, disintegrate. The lowermost functional megaspore gives rise to female gametophyte after its enlargement. So the female gametophyte in gymnosperm is monosporic, except *Gnetum* which is tetrasporic.
- (10) During the development of female gametophyte free nuclear division of the functional megaspore followed by wall formation surrounding the daughter nuclei takes place (except *Gnetum*, *Welwitschia*). The female gametophyte thus becomes cellular and such cellular mass is known as **primary endosperm**. The endosperm of gymnosperm is haploid (n) and it is formed before fertilization. It is one of the important characters by which gymnosperms could be distinguished from angiosperms where the endosperm is formed after fertilization and it is triploid (3n). Archegonia differentiate towards the micropylar region of the primary endosperm (except *Gnetum*, where the free nuclear female gametophyte with one enlarged egg nucleus is formed).
- (11) The archegonium is made up of neck, ventral canal cell and egg. No neck canal cell formation takes place in the archegonium.

- (12) Microspore is the first cell of the male gametophyte. It has two layers, such as outer exine and inner intine. In the members of Pinaceae the exine layer becomes inflated and forms wing.
- (13) The male gametophyte is made up of prothallial cell, stalk cell, body cell and tube cell. No prothallial cell formation occurs in the members of Taxodiaceae, Cupressaceae, Cephalotaxaceae and Taxaceae. Again multiple prothallial cell formation takes place in Araucariaceae and Podocarpaceae. The body cell usually divides and forms two male gametes. More than two gametes are formed in *Cupressus*, *Juniperus* etc. The gametes may be ciliated or nonciliated types.
- (14) Gymnosperms are wind pollinated. The floating pollen grains in the air are caught up by the pollination drop that oozes out of the micropylar end of the ovule. Due to drying up of pollination drop pollen enters into the ovule and on germination brings about pollination. The pollen germinates to give rise pollen tube through which gametes proceed and fertilize egg. This kind of pollination where gametes need to move through pollen tube is known as **siphonogamy**. The male gametes are ciliated, and pollination mediated by ciliated gamete is known as **zoidogamy**.
- (15) After fertilization, zygote is formed. Zygote divides and re divides to form embryo. There are three stages of embryo development: a) Formation of free nucleated proembryo- produced as a result of multiple division of zygote nucleus. b) Formation of cellular proembryo- wall formation surrounding the nuclei makes this stage in which two distinct regions are differentiated such as lower primary embryonal region and upper cellular region. c) The embryo proper is produced from the primary embryonal region.
- (16) The seeds of gymnosperm contain multiple embryos. Such multiple embryo formation is known as polyembryony. Though multiple embryo formation occurs due to fertilization of egg in multiple archegonia, but only one attains maturity. In conifers, four cells of the embryo separate from each other and each of them gives rise to an embryo separately. This phenomenon is known as **cleavage polyembryony**. Though all four embryos differentiate but ultimately one attains maturity and others disintegrate.
- (17) The ovule after fertilization forms seed. The zygote present in the seed develops into embryo. Endosperm present as nutritive tissue inside the seed. Nucellus either disintegrates or may be present as remnants of degenerative tissue towards the micropylar end of the seed called nucellar cap. The innermost layer of the

integument forms tegmen and the hard sarcotesta of the integument forms testa of the seed.

7.5 □ *Cycas*

Cycas grows well in xeric habitat. It is a large tree and appears like a coconut tree. The stem is columnar covered by persistent leaf bases. In India *Cycas* is represented by six species, such as:

- i) *Cycas circinalis* L.: It is found to grow in the deciduous forest of South India. The stem is unbranched and attains 4m height. A carbohydrate commonly known as sago is obtained from the stem of this species.
- ii) *Cycas pectinata* Buch.-Ham.: This species is distributed mainly in Eastern India like Sikkim, Assam, Bihar etc. The plant attains a height of 3.5 m. At the base of the petiole some spiny outgrowths are observed. The male cone of this plant is slightly stalked, cylindrical and its height may attain upto 40cm.
- iii) *Cycas beddomei* Dyer.: This species is densely distributed in Kudappa region of Andhra Pradesh where it is commonly known as perita. The stem is dwarf, about 40 cm tall. Spine like structures are absent at the base of the petiole. Spines are replaced by dense hair.
- iv) *Cycas rumphii* Miq. The stem of this plant is branched. The leaves are 1-2 m in length and the stem attains about 4m height. This species are distributed in a dense frequency in Andaman and Nicobar Island.
- v) *Cycas revoluta* Thunb. It is a Japanese species growing as ornamental garden plant in India. Only female plant of this species is found. It is known as Tosso in Japan. It propagates by formation of bulbils.
- vi) *Cycas siamensis* Miq.: Though this species is exotic but cultivated in India as a garden plant.

According to Bierhorst (1971) there are twenty species of *Cycas*. The species other than the above mentioned six are *C. media*, *C. normanbyana*, *C. madagascariensis*, *C. taiwaniana* etc.

7.5.1 External morphology

Cycas is a terrestrial perennial plant. The sporophyte of this plant is differentiated into root stem and leaves. The stem is columnar, usually unbranched but rarely branched in some species. The leaves are pinnately compound and remain aggregated densely and spirally at the apex of the stem. The stem surface is covered by armour of persistent leaf bases. The vegetative reproductive organ of this plant is known as bulbil which is produced as bud like outgrowth at the base of the stem and remains partially covered by scaly outgrowth.

Two types of leaves are present on the plant such as – i) Green photosynthetic compound foliage leaf and ii) Scale leaf. The green, compound foliage leaves remain aggregated at the apex of the stem. Each leaf has a single hard rachis on which the leaflets or pinna are arranged on both the sides in a slightly alternate manner. The leaflets are sessile and the basal ones are comparatively stronger. The leaves are acute with entire margin. Due to the presence of thick layer of cuticle on the surface the leaves appear glossy. At the immature stage the leaves show circinate vernation.

The scale leaves are greater in number, brown, tough and they are found to be present more densely at the apex of the stem. Such scale leaves are alternately present with the green foliage leaves and serve as a protective organ of the immature green assimilatory leaves. (Fig. 7.1)

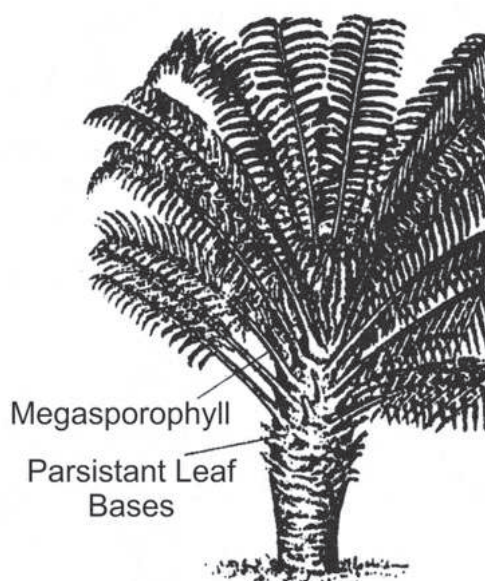

Fig. 7.1 : Mosphology of *Cycas* plant.

In *Cycas* tap root system is found which is greater in circumference and persistent. From such tap root system many adventitious roots come out, which grow parallel to the surface and then come out from the soil. Such ageotropic roots are initially infected by bacteria. The bacterial infection is followed by algal infection. An alga *Anabaena cycadae* (class: Cyanophyceae) enters into the root through the bacterial infection locus. The algal filaments grow rapidly both inter and intracellularly in the cortical region of the root. The

profuse growth of the algal filaments inside the cortical tissue forms a distinct algal zone. Due to repeated dichotomous branching of the root, it looks like a coral or knob. This special kind of root system of *Cycas* is known as **coralloid root** or **corallorhiza**. Having lenticel like apertures on the surface, such roots can perform aerial respiration. (Figs. 7.2a, b)

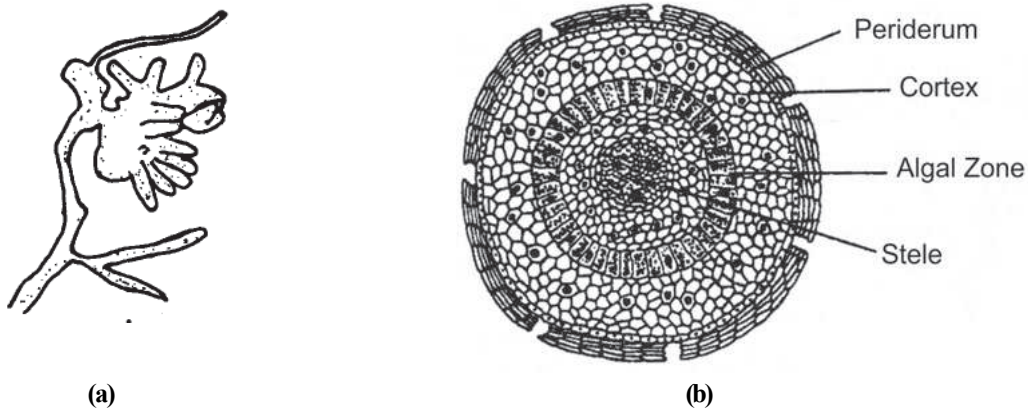

Fig. 7.2 : (a) Morphology of Corallorhiza, (b) Anatomy of Coralloid root.

7.5.2 Anatomical structure of stem

Internally the stem shows irregular outline due to persistent leaf bases on the surface. The following regions are found under microscopic observation:

- a) Epidermis:** It is the external layer of stem made up of highly cuticularised parenchymatous cells with persistent leaf bases.

Cortex: The extended parenchymatous region below the epidermis is known as cortex. The cells are densely arranged and filled with starch grains. Here and there in the cortex mucilage cavities are found which maintain their continuity with the mucilage cavity of pith and medullary ray. Another important character of the *Cycas* stem is the presence of girdling leaf trace. The leaf trace originates from the main vascular axis of the stem and before entry into the leaf base it encircles the entire cortex. Such leaf traces are called girdling leaf trace. (Fig. 7.3)

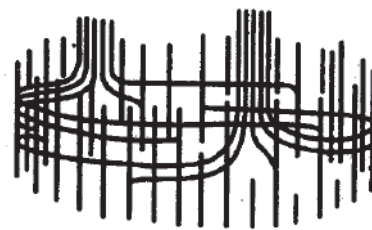

Fig. 7.3 : Girdling leaf trace in *Cycas*

Endodermis, pericycle and vascular cylinder: The endodermis and pericycle is not prominent. The vascular bundles encircle the central pith in a circular array. The vascular bundles are conjoint and collateral, open. Primary cambium is present inbetween xylem and phloem. The span of activity of such cambium is very short. Soon after the activity of primary cambium is ceased, secondary cambium is formed which is responsible for the formation of secondary xylem and phloem. Thus, secondary growth and successive rings of cambium formation is common in *Cycas*. Though secondary growth occurs but the amount of secondary wood is scanty. Medullary rays are present inbetween the vascular bundles. Xylem is made up of tracheids and xylem parenchyma. Vessels or trachaea are absent in the xylem. Phloem is made up of sieve tubes and phloem parenchyma. Companion cells are absent. The protoxylem tracheids have spiral thickening whereas metaxylem tracheids have scalariform thickening. Besides, bordered pits are present in alternate row in the metaxylem tracheids. (Fig. 7.4)

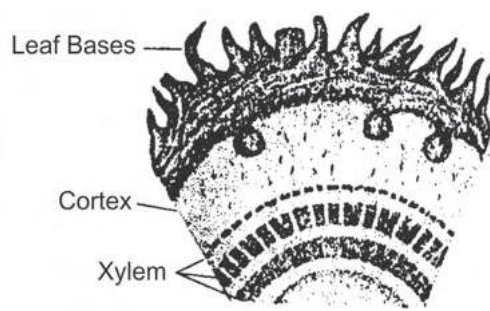

Fig. 7.4 : T. S. through the stem of *Cycas*.

7.5.3 Anatomy of leaf

The leaf of *Cycas* is made up of two parts such as i) rachis or midvein ii) Leaflets arranged on both side of rachis.

7.5.3.1 Rachis: The outline of rachis in TS is round. It is differentiated into three regions such as epidermis, cortex and central cylinder or stele. The epidermis is made up of cuticularised parenchyma cells. The outer cortex is made up of chlorenchymatous cells which constitute hypodermis. The inner cortex is made up of parenchymatous cells and within this region mucilage canals are found. Two endarch vascular bundles are found at the base of the rachis. Such bundles are divided into many fragments which remain distributed in the ground tissue by forming a ω (omega) shaped region. Each bundle is open, collateral and bears both centripetal and centrifugal xylem. So the bundles are diploxylic or

pseudomesarch type. Each bundle remains covered by sclerenchymatous sheath. Transition from endarch to exarch arrangement is observed when the bundles proceed more interior towards the leaf. (**Fig. 7.5**)

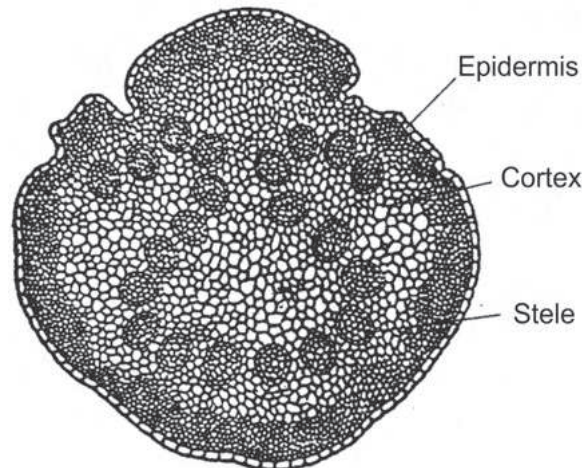

Fig. 7.5 : Anatomy of rachis of *Cycas*

7.5.3.2 Leaflets: T.S. through the leaflets reveals the following tissue differentiation.

- i) **Epidermis:** In the leaflet there are two epidermal layers. The upper epidermal layer is continuous, made up of parenchymatous cells which are heavily cuticularised. The lower epidermis is interrupted here and there by sunken stomata.
- ii) **Hypodermis:** Just below the epidermis hypodermis is present which is made up of uniseriately arranged cell. The same layer is also present above the lower epidermis. Being heavily thickened the hypodermal cells prevents excessive heating of the leaves.
- iii) **Mesophyll tissue:** The ground tissue of the leaf is differentiated into palisade and spongy region. The palisade region is made up of columnar, chloroplast containing cell whereas spongy region is made up of loosely arranged chloroplast containing cells with intercellular spaces.
- iv) **Transfusion tissue:** Inbetween palisade and spongy parenchyma cells some transversely arranged, lignified cells are present in three layers which extend from midrib towards periphery of the leaves; the tissue made up of such specialised cells are called transfusion tissue. As the mid vein does not produce any lateral

vein, the transfusion tissues perform lateral conduction of food. Besides, such tissue also provides mechanical strength to the leaf to some extent.

Vascular bundle: The vascular bundle of the leaf is made up of xylem and phloem. The xylem is present towards upper surface and phloem towards the lower surface of the leaf. Tracheids are abundantly present in the xylem. The protoxylems of the bundle remain encircle by metaxylems that means the vascular bundles of the leaves are mesarch. **(Fig. 7.6)**

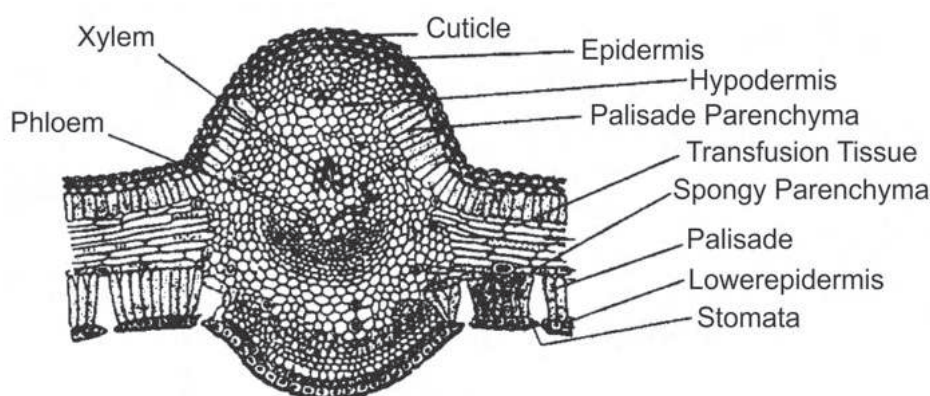

Fig. 7.6 : T. S. through the leaf of *Cycas*

7.5.3.3 The xerophytic features of *Cycas* leaves: The leaves of *Cycas* possess some specific characters that help the plant to grow under habitat where water availability is low. The important xerophytic characters of *Cycas* are listed below: i) The epidermis of leaf is covered with thick layer of cuticle. ii) The stomata are sunken type which prevents water loss from the plant. iii) Presence of primary and secondary transfusion tissue in the leaf. iv) Stomata are only restricted at the lower epidermis of leaf. iv) The leaves are restricted at the apex of the plant body and therefore the surface area for transpirational water loss is extremely reduced.

7.5.4 Anatomy of root

The root anatomy of *Cycas* is similar to that of dicotyledonous plants. The root epidermis is made up of single layer of parenchyma cells. Next to the epidermis, cortex is present which is made up of thin parenchymatous cells. The endodermis is the innermost layer of cortex which encircles the central cylinder or stele. The stele may be diarch or tetrarch. The xylem is exarch. The secondary growth occurs in the older part of root. The

number of phloem bundles is more or less fixed in different species. The root apex remains protected by root cap which differentiates from periblem. No calyptrogen formation is reported in any species. The structure of coralloid root is similar to primary roots. Thick algal zone is found in the cortex by disintegration of parenchyma cells. The common algal inhabitants inside the cortical region of the root are *Nostoc*, *Anabaena*, *Calothrix* etc. They help in the growth of host plant by fixing atmospheric nitrogen. **(Fig. 7.7)**

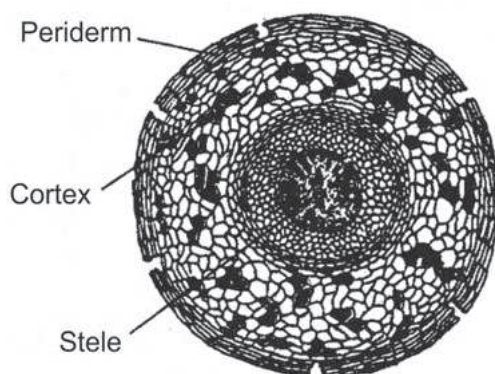

Fig 7.7 : Anatomy of root of *Cycas*.

7.5.5 Reproduction of *Cycas*

Vegetative reproduction is found in *Cycas revoluta*. It is the only species where vegetative reproduction takes place. Absence of sexual reproduction is due to the lack of male plants in India. The species reproduces vegetatively by bulbils that develop towards the base of the stem. Bulbils detach from the mother plant and develop into new individual. No seed formation occurs in this species as sexual reproduction is absent.

7.5.5.1 Sexual reproduction: *Cycas* is dioecious i.e. male and female reproductive organs are produced in different plants. The male reproductive organs are microsporophylls which are aggregated on an axis to form a club shaped structure, called male strobilus. The female reproductive organs are megasporophylls which do not aggregate to form any strobilus. The megasporophylls are borne in multiple numbers towards the apex of the stem of female plant. Usually a single male strobilus is developed at the apex of the stem. The growth of the male strobilus does not cease the growth of the main axis. At the axial position of the male strobilus vegetative bud is formed, the activity of which regulates the axial growth. So, the axis of the male plant of *Cycas* is known as sympodium. As the apical growth of the main axis continues the male strobilus takes the lateral position.

7.5.5.2 Male strobilus: The male cone of *Cycas* is enlarged, woody, elongated, club shaped structure with hemispherical apical end. The length of male cone may reach up to 40-50 cm. There is a central axis of the strobilus surrounding which microsporophylls are spirally and densely arranged. The microsporophylls at the apex and base of the strobilus are sterile. The remaining microsporophylls are fertile and bear sporangia. The microsporophyll gradually tapers towards its basal end and the apical end becomes expanded to form a sterile structure called **apophysis**. Just below the apophysis, on the abaxial surface of the sporophyll many sporangia are produced. The sporangia are aggregated to form sori. Microspores or pollen grains are produced inside the microsporangia. The wall of the sporangium according to some scientists is differentiated into exothecium and endothecium. Thickening of the outermost cell layer of exothecium occurs except in two rows of cells. The latter helps in the dehiscence of the sporangium along such longitudinal lines. The sporophylls are separated from each other due to elongation of the axis of the strobilus after attaining maturity. The cells of exothecium which are less thickened contract excessively due to loss of water from the sporangium. This contractile force helps the sporangium to get dehisced along the line of thin walled less thickened cells.

The spores of *Cycas* are dispersed through wind. The spore wall is thicker at both the poles. The spore wall is differentiated into outer exine and inner intine. The development of spores in the form of sorus, dehiscence of the sporangium along its length, presence of annulus, production of numerous microspores etc. are considered as the primitive characters of *Cycas*. (**Figs. 7.8**)

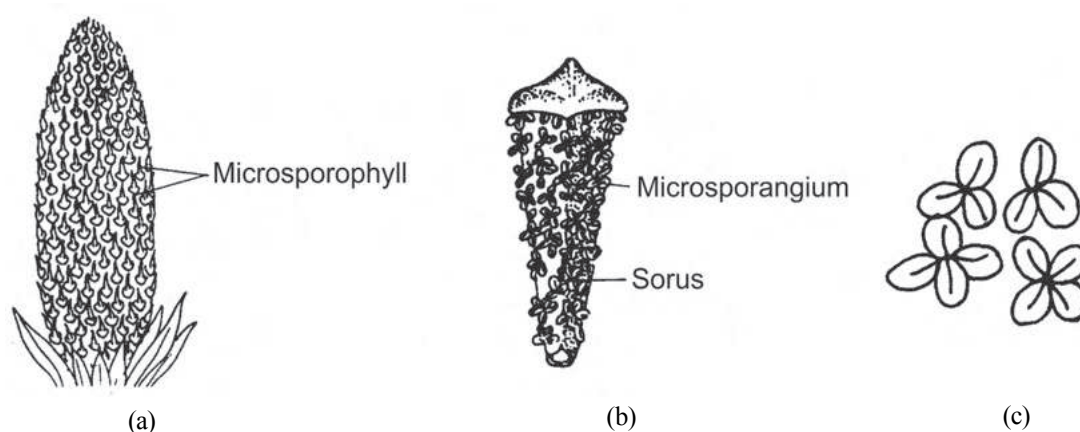

Figs. 7.8 : (a) Male strobilus of *Cycas*, (b) a single microsporophyll, (c) Sori of *Cycas*.

7.5.5.3 Megasporophylls: The megasporophylls are arranged in multiple layers at the apex of the plant body and remain intermingled with scales. The number of scales is greater than the number of assimilatory leaves. As the megasporophylls are loosely arranged, they never form any strobilar organization. The mature megasporophylls are located towards the lower end of the shoot apex whereas the immature ones are distributed towards the upper end of the shoot apex. The shoot axis of the female plant is monopodial since the meristem of the shoot apex can grow through the loosely arranged photosynthetic leaves and scale leaves. In *Cycas revoluta* the length of the megasporophyll ranges from 6-8 inches. The megasporophylls in this species are heavily elongated and consists of two parts- the upper expanded leaflike part and lower stalk like part. The leaf like extended part is acute and consists of many lobes. The ovules are arranged on both sides of the stalk like part and their number may vary from 2-10. The ovules remain covered by woollen or hairy outgrowth during immature stage which disintegrates on maturity. The matured ovules are orange or reddish in colour.

A clear trend of reduction in size, shape and structure of the megasporophyll is observed among different species of *Cycas*. In *Cycas rumphii*, the expanded portion of the megasporophyll is comparatively smaller in size than *C. revoluta*. The number of ovule per megasporophyll is 8. Further reduction in size of the megasporophyll is observed in *Cycas circinalis*. Here the number of ovule has been reduced to 4-5. In *C. thouarsii*, however, the megasporophyll has been reduced gradually and assumes the shape of pinnate compound leaf. The highest level of reduction in the number of ovules is observed in *C. normanbyana*. Here the number of ovules has become reduced to two. (Fig. 7.9)

7.5.5.4 Structure of ovule: The ovule of *Cycas* is enlarged and slightly flattened. It is covered by an integument which is

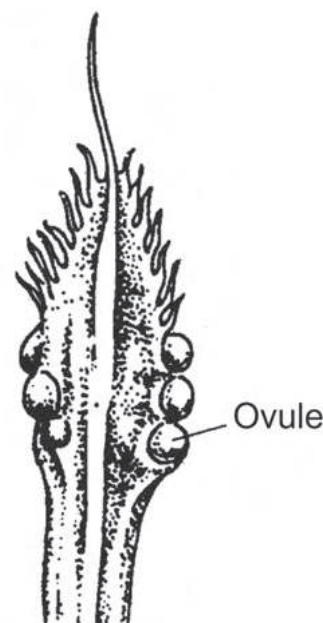

Fig. 7.9 : A megasporophyll of *Cycas*.

differentiated into three layers. The outer fleshy layer is called **sarcotesta**, middle stony layer is called **sclerotesta** and the innermost fleshy layer is called **endotesta**. The ovule is hard due to the presence of tough layer sarcotesta. The micropyle, chalaza and nucellus of the ovule remain in a straight line that means the ovule is orthotropous type. The endotesta of the integument surrounds the central nucellus tissue. The latter forms a protuberance towards the micropyle, which is called nucellar beak. Some cells of the nucellar beak disintegrate and form a chamber called pollen chamber where the pollen germinate after fertilization. The embryo sac is formed inside the nucellus. The embryo sac following the developmental stages becomes filled with a tissue called endosperm. The latter is also known as female prothallus, towards the micropylar end of which 3-6 archegonia are produced. Each archegonium is made up of two neck cells, one ventral canal cell and an egg. The neck of the archegonium is exposed in a cavity towards the micropylar end of the ovule called archegonial chamber. Such chamber is a basin shaped cavity formed as a result of spatial orientation of cells and tissues adjacent to the neck of the archegonia of the female prothallus. The archegonial chamber is located beneath the pollen chamber which remains filled with a liquid.

The vascular trace that enters at the base or chalazal end of the ovule divides thrice into three separate strands. The central strand extends vertically upto the base of the nucellus where it divides repeatedly to form many smaller strands. The two outer strands enter into sarcotesta on both sides of the ovule. After moving a little distance each of them divides dichotomously into larger exterior strand and inner small interior strand. The exterior ones proceed through the sarcotesta and terminate at the micropyle of the ovule. The interior branch enters into the sclerotesta and after piercing the latter enter into the endotesta.

(Fig. 7.10)

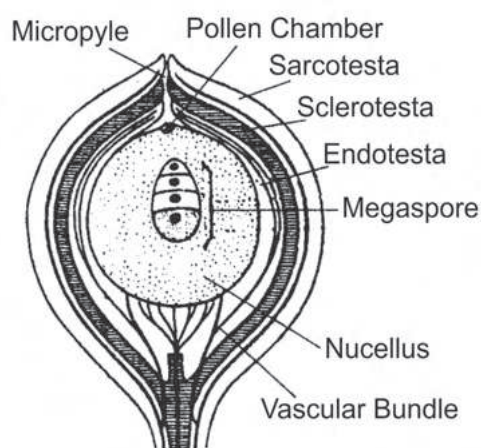
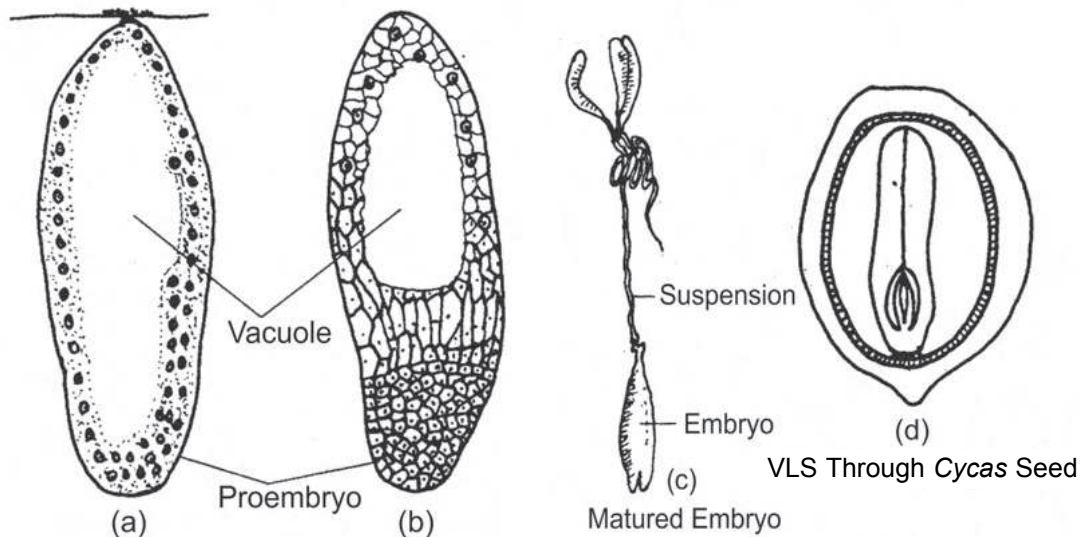

Fig. 7.10 : Structure of ovule of *Cycas*.

7.5.5.5 Pollination and fertilization: *Cycas* is wind pollinated. The pollen grains are released from microsporangia in three celled stage. A mucilaginous substance is oozed out through the micropyle of the ovule which is called **pollination drop**. The air borne pollen are caught in such drop. They reach at the pollen chamber due to drying up of the pollination drop. After pollination is over the passage of the micropyle is closed. The pollen germinates to produce pollen tube which proceeds through the nucellar tissue reach at the archegonial chamber where the apex bursts open to release the ciliated spermatozoids. The spermatozoid enters into the archegonium and fertilizes the egg nucleus present in it after a brief period of motility inside the fluid of the archegonial chamber. The fertilized egg ultimately produces multicellular embryo that remains embedded inside the seed.

7.5.5.6 Structure of seed: The integument layer of the ovule sufficiently hardens to form seed coat. The outer layer of the integument remains closely pressed over the hardy or stony scelerotesta. The innermost layer of the integument disintegrates. The endosperm tissue is located inside the integument. The embryo proper is located along the length of the seed at the central part of the endosperm tissue. The suspensors are present in aggregate towards the micropylar end in the form of condensed tissue. A pad like tissue region is observed at the radicle end which is known as coleorrhiza. It protects the soft apical end of the radicle. (Fig. 7.11).



Figs. 7.11 : Developmental stages of embryo in *Cycas* (a-c), Structure of a seed (d)

7.5.5.7 Systematic position: Division : Gymnosperm

Class : Cycadopsida

Order : Cycadales

Family : Cycadaceae

Genus : *Cycas*

Species : *circinalis* L.

7.5.5.8 Life cycle of *Cycas*:

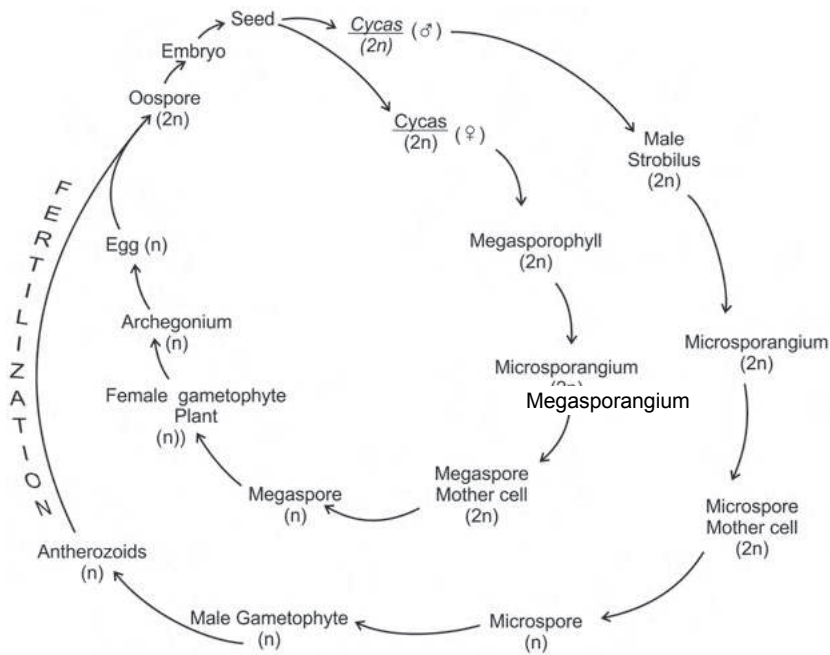

Word diagram 7.1 : Life cycle of *Cycas*

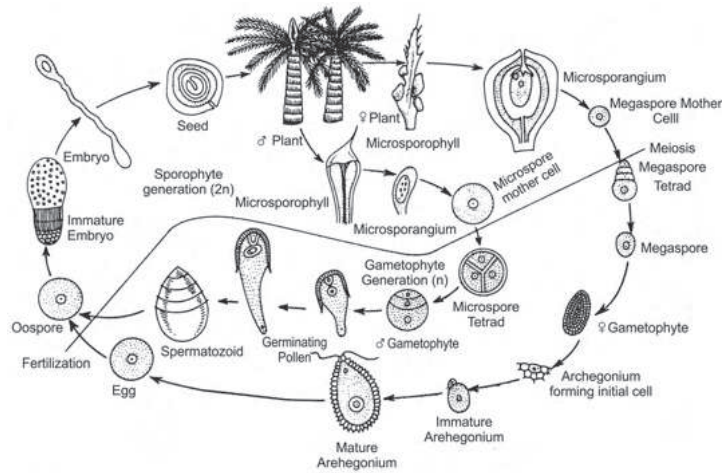

Life Cycle of *Cycas*

7.6 □ *Pinus*

Pinus is an important genus belongs to the family Pinaceae. It has 90-100 species distributed worldwide. The plants usually grow on the hill slope and form dense evergreen forest. In northern hemisphere dense growth of different species of this genus is observed. The resin and wood obtained from this plant is economically important. The seeds of few species are used as food.

In India distribution of six species of this genus is observed, which are as follows:

- a) ***Pinus roxburghii* Sarg (= *P. longifolia*):** This species is commonly known as **chir pine**. Its rich vegetation is observed in eastern and western Himalaya. Three needle shaped leaves in the form of bunch grows on the apex of dwarf shoot. The seeds are winged and edible. They are found to grow 1500- 7500 ft height above sea level. The height of the plant is about 50-60 mt, and the diameter of the stem ranges from 1.5 to 3.0 mt.
- b) ***P.wallichiana* A.B. Jacks.(=*P.excelsa*):** It is commonly known as **blue pine** that grows upto the height from 6000 to 11000 ft above the sea level. Luxuriant growth of this species is found in North Eastern Frontier Area (NEFA). The plant is typical pyramidal shape, 100-150 ft height and 8-10 ft diameter. A bunch consisting of five needles is found at the apex of dwarf shoot. Ten to twelve cataphylls remain spirally arranged surrounding the dwarf shoot. The cataphylls are also known as prophylls. The male cones are produced from the axil of the scale leaves present on the dwarf shoot.
- c) ***P.gerardiana* Wall.ex D.Don :** The seeds are sold in the market as chilgoza and therefore the species is known as **chilgoza pine**. This species is distributed in the North Western Himalaya at the height between 5000 to 12000ft. Dense vegetation is formed by this species in the Himalayan region of Kashmir. The dwarf shoot is characterised by the presence of three needle like leaves at the apex.
- d) ***P. kesiya* Royle ex Gordon (= *P. khasya*):** This species grows densely in the Khasi hill and therefore it is popularly known as **khasi pine**. This species is absent in Western Himalaya. The plant may attain a height of 75 -100 ft.

- e) ***P. merkusii* Jungh. & de Vriese:** This species could be distinguishable from other species by having two needle like leaves at the apex of dwarf shoot. The Eastern Himalayan region of India is the main site of distribution of this species.
- f) ***P. armandii* Franch.:** It is an exotic species brought from China with five needle shaped leaflets at the apex of the dwarf shoot. It is found to grow in the extended region of North East area of Assam.

7.6.1 External features

The main plant body is a perennial sporophyte, differentiated into root, stem and leaves. The plant looks like a pyramid because its lower branches are longer and the branches towards the apex gradually become shorter in length. The different parts of the sporophyte are described below:

1. **Long and dwarf shoot:** The bud present at the axil of the scale of the main axis gives rise to a branch of indefinite growth called **long shoot**. The length of the long shoots is greater towards the base and gradually become shorter at the apex of the plant body giving a pyramid shaped appearance of the plant body. The long shoot also possesses many scales. The bud present at the axil of such scale gives rise to **dwarf shoot**. The long shoot bears many scars on its surface which are produced as a result of shedding of the dwarf shoots. The male cone is produced from the bud developed at the axil of the scale leaves of long shoot.

The dwarf shoots are produced vertically from the long shoot. Their length may be 1-2". The number of scales on the dwarf shoot may vary from 10-12. The scales are called cataphylls. The first formed pair of cataphylls are opposite in their arrangement and are called prophylls. The remaining pairs are spirally arranged. The last formed pair of cataphylls is larger in shape. The terminal vegetative bud of dwarf shoot is short lived and it limits the growth of the axis after being inactivated. Needle like leaves are produced at the apex of the dwarf shoot in bunch. [Fig. 7.12]

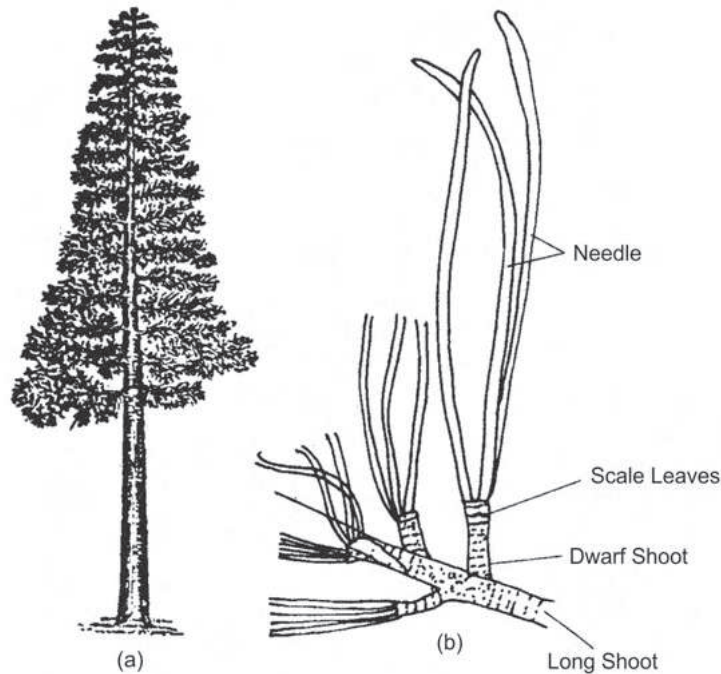

Figs. 7.12 : (a) Sporophytic plant body of *Pinus*. (b) Different parts of a shoot of *Pinus*.

2. **Leaves:** there are two types of leaves on the sporophyte. The green coloured photosynthetic foliage leaves, called needle and brown coloured leaves called scales or cataphylls. Needles are produced in bunch at the apex of the dwarf shoots. Such dwarf shoots with needles are called spur. Depending on the number of needles, the spurs may be monofoliar (e.g *P. monophylla*), bifoliar (e.g. *P.merkusii*), trifoliar (e.g. *P. roxburghii*), pentafoliar (*P. wallichiana*) etc. The needles are persistent and detach from the mother plant along with the detachment of dwarf shoot. Presences of thick cuticle, reduction in the surface area of the leaves (due to their typical needle shape) are important xerophytic characters of *Pinus* leaves.
3. **Root:** In *Pinus* though tap root system is observed but the roots could not penetrate deep into the soil due to their growth in stony soil of the hilly region. The primary tap root gives rise to lateral branches from which rootlets are produced that grow horizontally. Such rootlets are frequently infected by mycorrhizal fungus. Thus ectotropic mycorrhizal roots are very common in *Pinus*. The fungi belong to Boletaceae and Agaricaceae form mycorrhiza in *Pinus* root.

The mycorrhizal roots are identified by their short growth, lacking of root hairs and root cap.

7.6.2 Internal morphological features of *Pinus*

1. **Anatomy of stem:** The following tissue regions are visible in the TS through the stem of *Pinus*.
 - a) **Epidermis:** It is made up of single layer parenchyma cells. The cells are externally covered with thick cuticle.
 - b) **Cortex:** Just below the epidermis thick walled few layered hypodermis is present. Next to the hypodermis multilayered cortex is present which is made up of parenchyma cells. Inside the cortex many resin canals are present. The resin canal is encircled by a layer of parenchymatous epithelium. Exterior to the epithelium another thick walled cell layer is present which is called sclerotic sheath. The cells of the epithelium secrete resin inside the resin canal. Resin is used as natural source of turpentine. [Fig. 7.13]

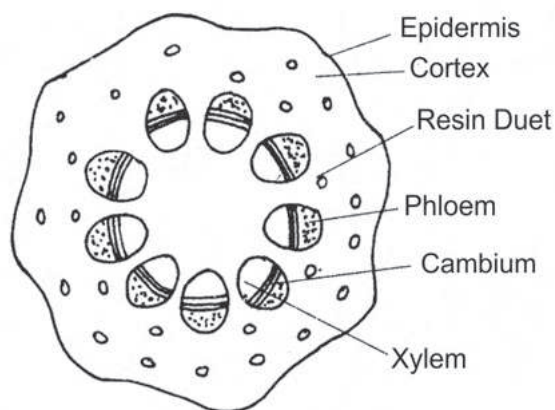

Pic. 7.13 : Diagrammatic representation of the T. S. through the stem of *Pinus*.

- c) **Stele:** The stele is siphonostelic i.e. parenchymatous pith is present at the centre which is surrounded by a ring of primary vascular bundles. The stele is delimited from the cortex by endodermis and pericycle. The vascular bundles are conjoint, collateral, and open and remain separated from each other by medullary rays. Primary xylem lacks tracheae and xylem fibres. Cambium ring formation takes place during secondary growth. The tracheids

of secondary xylem is characterised by a balloon like protuberance inside the cavity called tylosoid. Bordered pits are found on the wall of the tracheids. The protoxylem tracheids are characterised by spiral thickening whereas metaxylem tracheids have reticulate thickening. Besides wood rays are present in xylem. The phloem is made up of sieve tube and phloem parenchyma. Companion cells are absent. The sieve tubes are long and the transverse walls contain sieve plate. Albuminous cells are characteristically present in phloem tissue. The secondary wood of the stem has secondary medullary rays. The extrastelar secondary growth occurs by the activity of phellogen or cork cambium. Periderm formation occurs during secondary growth of stem. [Fig. 7.14]

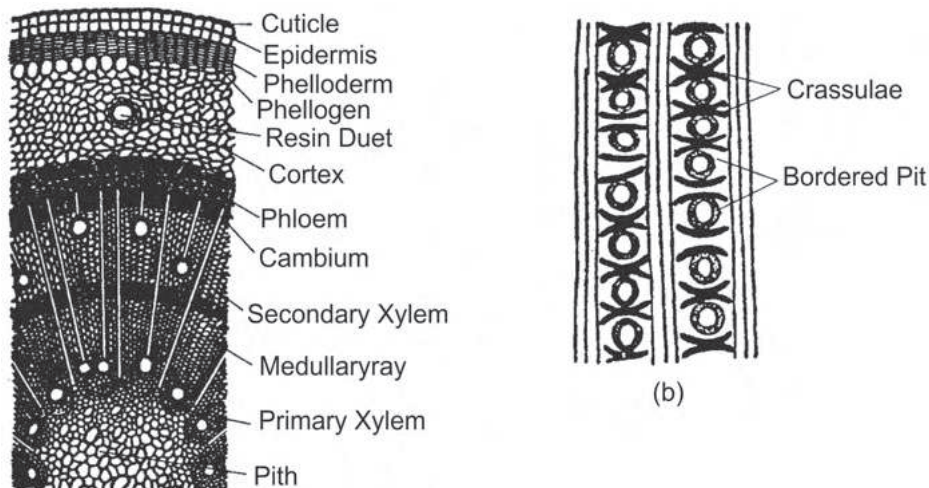

Fig. 7.14 : (a) T. S. through the wood of *Pinus*. (b) Xylem tracheid with bordered pit and crassulae.

- 2. Anatomy of root:** The root is covered by a external piliferous layer, the cells of which are densely arranged. Below the piliferous layer broad parenchymatous cortex is present. The stele of the root is encircled by endodermis and pericycle, the cells of which appear brown due to high content of tannin. The central cylinder of the root is mainly diarch, but sometimes triarch and tetrarch arrangements are also found in some species. The protoxylem is exarch. The protoxylems of vascular bundle of root form Y shaped organization. In between the arms of Y shaped protoxylem resin passages are present. Like stem the secondary growth occurs due to activity of phellogen or cork cambium. [Fig. 7.15]

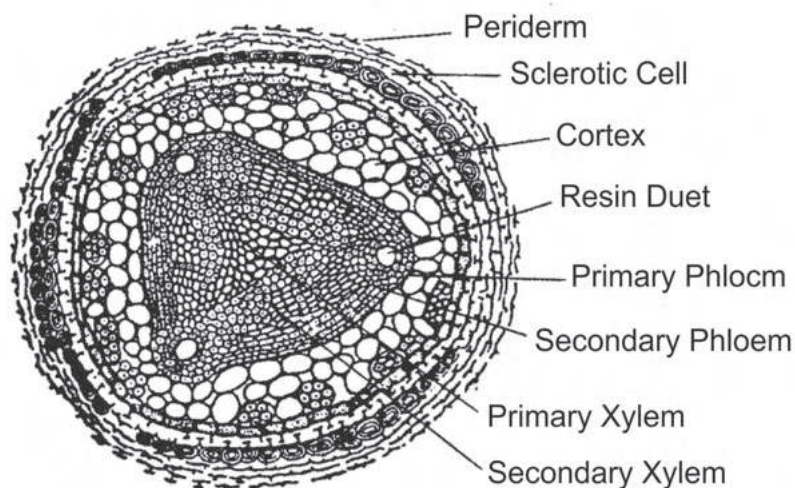

Fig. 7.15 : T. S. through the root of *Pinus*.

3. **Anatomy of leaf:** The TS through the leaf is more or less triangular in outline. The upper surface of the leaf is hemispherical and the lower surface is V shaped in outline. The anatomy of leaf shows typical xerophytic characters. The different tissue regions of the leaf are described below:
 - a) **Epidermis:** The epidermis of the leaf is parenchymatous, highly cuticularised. The continuity of the epidermal layer is interrupted by stomata. Stomata are sunken.
 - b) **Hypodermis:** The hypodermis of the leaf is multilayered and is made up of sclerenchyma cells. Below the stomata there is an air cavity which separates it from the hypodermis.
 - c) **Mesophyll :** The cells of the mesophyll tissue are not differentiated into palisade and spongy parenchyma. The cells are parenchymatous, thin walled and rich in chlorophylls and starch. Being rich in chlorophylls the cells can perform assimilation effectively. One important feature of the mesophyll cells is that their wall protrudes inside the lumen in the form of a finger like projection. Such projections are called arm palisades. They help in the aeration, absorption and deposition of excretory substances inside the palisade cells.

- d) Endodermis:** The central cylinder of leaf remains delimited from the cortex with the help of endodermis. The cells of this layer contain casperian strips at their junction.
- e) Pericycle :** This layer is present below the endodermis and is made up of many parenchyma cells as usual. Besides normal parenchyma cells two additional types of cells are present in the pericycle, such as: i) Albuminous cells: These cells are rich in protein and they help of transport of photosynthates from mesophyll cells to the phloem. ii) Tracheidal cells: These cells are located adjacent to the xylem tissue and resemble tracheids. They help in transport of water from xylem to mesophyll cells. Both the cells that is tracheidal and albuminous cells together constitute **transfusion tissue**. As the vascular bundles of leaf are not well developed that is why these tissues are formed to facilitate conduction. Other than transfusion tissue, some sclerenchyma fibres are present in the bundles which provide mechanical strength to the leaves.
- f) Vascular bundles:** The number of vascular bundles in the leaf is usually two though the number may vary according to species. The bundles remain separated from each other by sclerenchyma fibres. The phloem of the bundle is directed towards the upper hemispherical surface whereas the xylem is directed towards lower V shaped end of the leaf. The vascular bundles are conjoint and collateral. **[Fig. 7.16].**

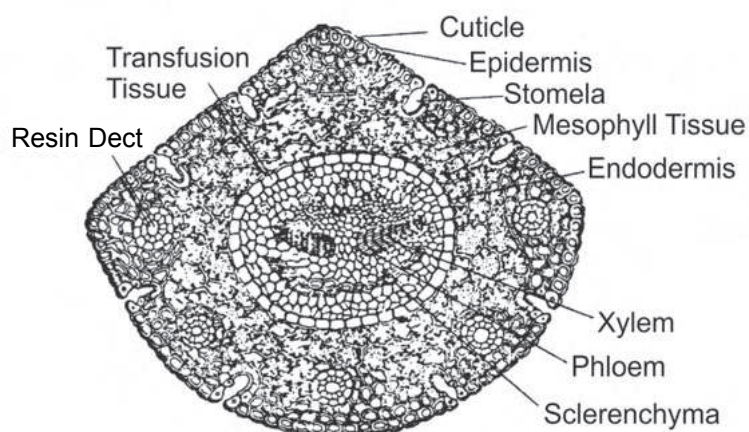

Fig. 7.16 : T. S. through *Pinus* needle.

7.6.3 Reproductive structure

Pinus is homothallic which means both male and female cones are present on the same plant. [Fig. 7.17]

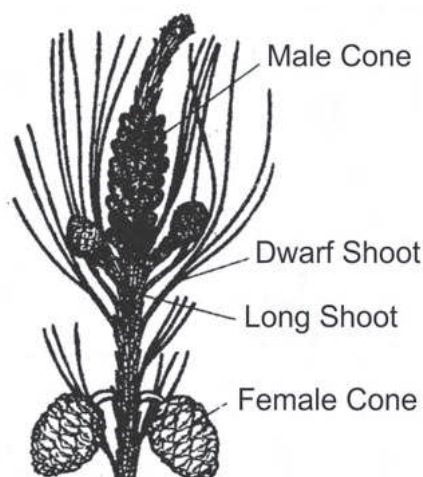

Fig. 7.17 : *Pinus* short showing position of male and female cone.

7.6.3.1 Male cone

The male cones or male strobili are produced in bunch at the apex of long shoot. Each strobilus is produced from the axil of the scale leaves. The bud present at the axil of scale leaf instead of producing dwarf shoot gives rise to male strobilus. Thus towards the apex of the long shoot the development of dwarf shoot is replaced by male strobilus. The number of strobili in the cluster may vary. In *P.wallichiana*, it is 15 whereas in *P.roxburghii* the number may extend upto 140. The length of male cone is 2-4 cm and it is slightly elliptical and shortly stalked. The male cones arise during the month of October- November and shedding of pollen from the strobilus usually starts at the beginning of April and it continues upto the month of June every year. Each strobilus is made up of a central axis surrounding which 60-140 brown coloured microsporophylls are densely and spirally arranged. The microsporophylls are stalked and they have an expanded apical part with acute apex called apophysis. On the upper surface of microsporophyll one pair of elongated microsporangia are produced.

7.6.3.2 Microsporangia

Are produced in eusporangiate manner. A group of hypodermal cell of the microsporophylls divide periclinally and form outer parietal cells and inner archesporium. The latter gives rise to spore mother cells which undergo reduction division to produce haploid microspores or pollen. The parietal cells divide periclinally and form the multilayered wall of the sporangium. The innermost few layers serve as nutritive tissue for the developing spores. Such nutritive layers are called **tapetum**. The microspores after attainment of maturity are released outside by bursting of sporangium along a longitudinal line of dehiscence.

7.6.3.3 Microspores

The microspores are small, boat shaped. They are covered with two layered envelope. The outer layer is called exine and the inner layer is called intine. The exine layer is highly inflated and forms two wing shaped structures called **sacci**. Thus the pollen grains in *Pinus* are bisaccate and winged. The wing like expanded exine provides buoyancy to the pollen grains and therefore the pollen could remain in a floating state for a long time in air. During the pollen shedding from microsporangia a yellow coloured cloudy mass is often seen to float in the air where there is a zone of dense vegetation of *Pinus*. Such yellow coloured floating spore mass of *Pinus* is known as ‘**Shower of Sulphur**’. The microspore wall also has a boat shaped marking called sulcus. The pollen grain of *Pinus* is therefore monosulcate type. [Fig. 7.18]

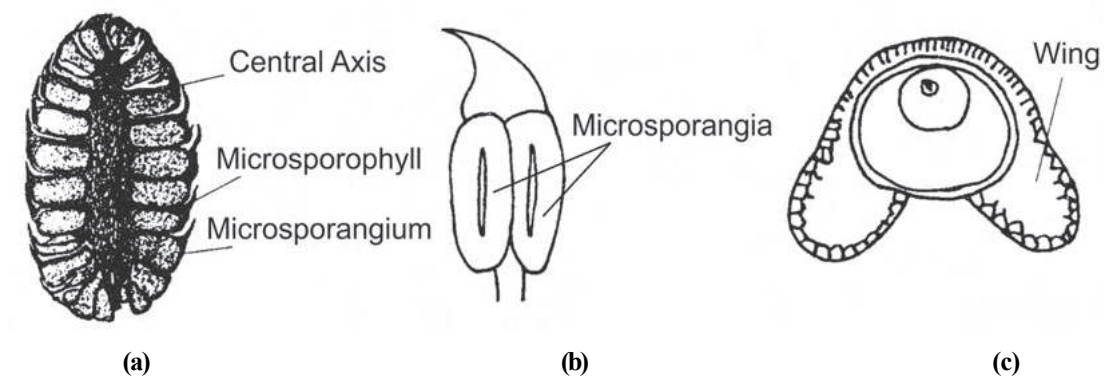

Fig. 7.18 : (a) VLS through the female cone of *Pinus*. (b) A single microsporophyll with two sporangia on its dorsal surface. (c) Winged pollen of *Pinus*.

Female cone: The female cones are larger in shape than male cones. These are produced at the sub-terminal location of the long shoot either singly or few in numbers. The bud presents in the axil of the sub terminal scale leaves give rise to the female strobilus. The number of the female strobilus at the apex of the long shoot though may vary from species to species but it never exceeds five. Each strobilus is 15-60 cm in length, brown coloured, woody and tough. The megasporophylls remain densely arranged in the female cone at the immature stage but separate from each other and loosely arranged on attaining maturity. There is a central axis of the female strobilus surrounding which megasporophylls are spirally arranged. Each megasporophyll is differentiated into two parts. The upper broad expanded ovule bearing part is known as **ovuliferous scale** and the lower small sterile basally attached scale like part called **bract scale**. The ovuliferous scale is thin at its base but the apical portion is expanded and forms a flattened rhomboidal apex called apophysis. At the centre of the apophysis a slightly elevated cone shaped region is found which is called **umbo**. The ovuliferous scale bears two ovules at its upper surface towards the basal end. The female strobilus usually emerges during the month of February – March but it takes about 22 months to release seeds from it. [Fig. 7.19]

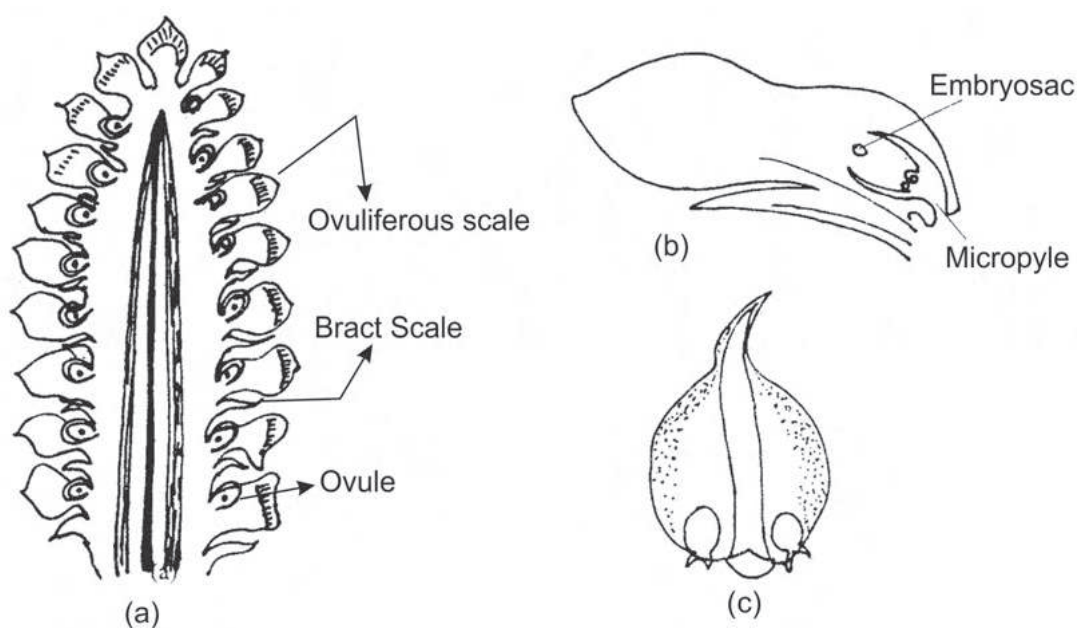

Fig. 7.19 : (a) VLS through the female cone of *Pinus*. (b) A single megasporophyll showing the position of ovule. (c) Top view of megasporophyll showing the position of two ovules on its dorsal side.

7.6.3.4 Structure of ovule

The ovule of *Pinus* is anatropous, that means ovules are inverted. The ovule is covered by a single integument differentiated into three layers. The outer layer is fleshy, called sarcotesta and middle layer is stony called sclerotesta and the innermost layer is known as fleshy endotesta. The integument encircles the female prothallus including nucellus of the ovule. The nucellus is fused with the integument at the chalazal end remains free at the micropylar end. Inside the nucellus megaspore mother cell differentiates which on reduction division gives rise to four haploid cells. The three upper cells of linear tetrad disintegrate and the innermost one becomes functional. The latter develops into female gametophyte. Towards the micropylar region of the ovule, the nucellar tissue disintegrates and forms a cavity called pollen chamber where the developmental stages of the pollen grain takes place after pollination.

7.6.3.5 Morphological nature of the ovuliferous scale of *Pinus*

Divergent views have been proposed by different Gymnologists to explain the morphological nature of the ovuliferous scale of *Pinus*. The different views are narrated below:

- a) According to Robert brown (1827) the ovuliferous scale is a free carpellary leaf that bears naked ovules and it emerges from the axil of the bract scale.
- b) Schleiden(1829) described ovuliferous scale as a placenta forming flattened axis and it is not at all a carpellary leaf.
- c) A. Brown (1842) opined that the ovuliferous scale is the first two leaves of the axis which are fused with each other.
- d) Dickson (1860) considered the ovuliferous scale as a small axis that bears a pair of ovule at its axillary position. This view was also supported by Goebel.
- e) Van Tieghem (1869) regarded the ovuliferous scale as the first formed leaf of a suppressed or dwarf axis that develops from the axil of the bract scale.
- f) Celakovsky (1879) described the ovuliferous scale as an outer integument which is located outside the ovule.
- g) Bessey (1892) supposed the ovuliferous scale as two fused outgrowths developed from the chalazal end of the two ovules.

- h) Chamberlain (1934) described the bract scale as megasporophyll from the axil of which ovuliferous scale has emerged. The ovuliferous scale is basically a modified shoot that bears megasporangium or ovule.
- i) According to Brachyblast theory proposed by Brown, the female cone is comparable to an inflorescence where the ovuliferous scale is a fertile two leafed dwarf axis which is axillary in position. Each leaf bears a single ovule at its upper surface.
- j) Delpino marked the ovuliferous scale as two lateral lobes emerged from bract scale which bend inward and fused with each other. According to Hirmer, the ovuliferous scale and bract scale are two different branches of the same sporophyll which have been split vertically. Most of the Morphologists support the view that the ovuliferous scale is a branch since it is axillary in position of the bract scale. The bract scale according to them is a scale leaf and the ovuliferous scale is a dwarf shoot.
- k) Florin (1951) on the basis of fossil evidences denoted the ovuliferous scale and bract scale as a seed cone complex. According to him the female cone is an inflorescence having a central axis homologous to rachis or peduncle. The bract scale developed on the axis is a true scale whereas the ovuliferous scale is a reproductive structure bearing modified shoot.

7.6.3.6 Pollination and fertilization

Like *Cycas*, *Pinus* is wind pollinated. During pollination a mucilaginous drop oozes out from the micropyle of the ovule in which the floating pollen grains are collected. Upon drying of such pollination drop the pollen reach at the pollen chamber where germination takes place. Pollen tubes produced as a result of germination of pollen grains pierce through the nucellar tissue and reach at the archegonial chamber. The pollen tube passes through the neck of the archegonium and reaches the venter where its apex bursts to release two gametes. One of the gametes disintegrates and the surviving one fuses with the egg nucleus to form zygote. The zygote undergoes the process of embryogeny and forms complete mature embryo.

7.6.3.7 Structure of Seed

Pinus produces winged seeds. A part of ovuliferous scale including the integument is responsible for the formation of winged structure of the seed. The integument layer forms the seed coat. The hardy or stony layer of the integument i.e. sclerotesta forms the testa and the inner endotesta if integument forms the tegmen of the seed. The seed is endospermic and within the endosperm embryo remain impregnated. At the micropylar end of the seed a remnant of nucellar tissue rests in the form of a cap which is called nucellar cap. The seed usually exhibit a prolonged period of dormancy and after that germinates to produce new individual. The germination of seed is epigeal type. [Fig 7.20]

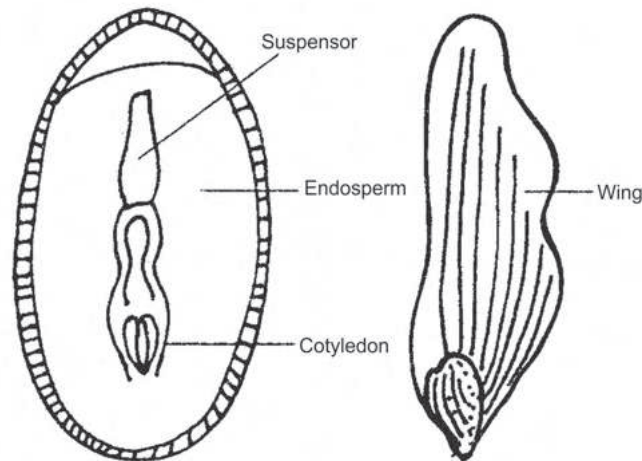

Fig. 7.20 : Structure of seed of *Pinus*

7.6.3.8 Systematic position of *Pinus*

Division : Gymnosperm

Class : Coniferopsida

Order : Coniferales

Family : Pinaceae

Genus : *Pinus*

Species : *roxburghii*.

7.6.3.9 Life cycle of *Pinus*

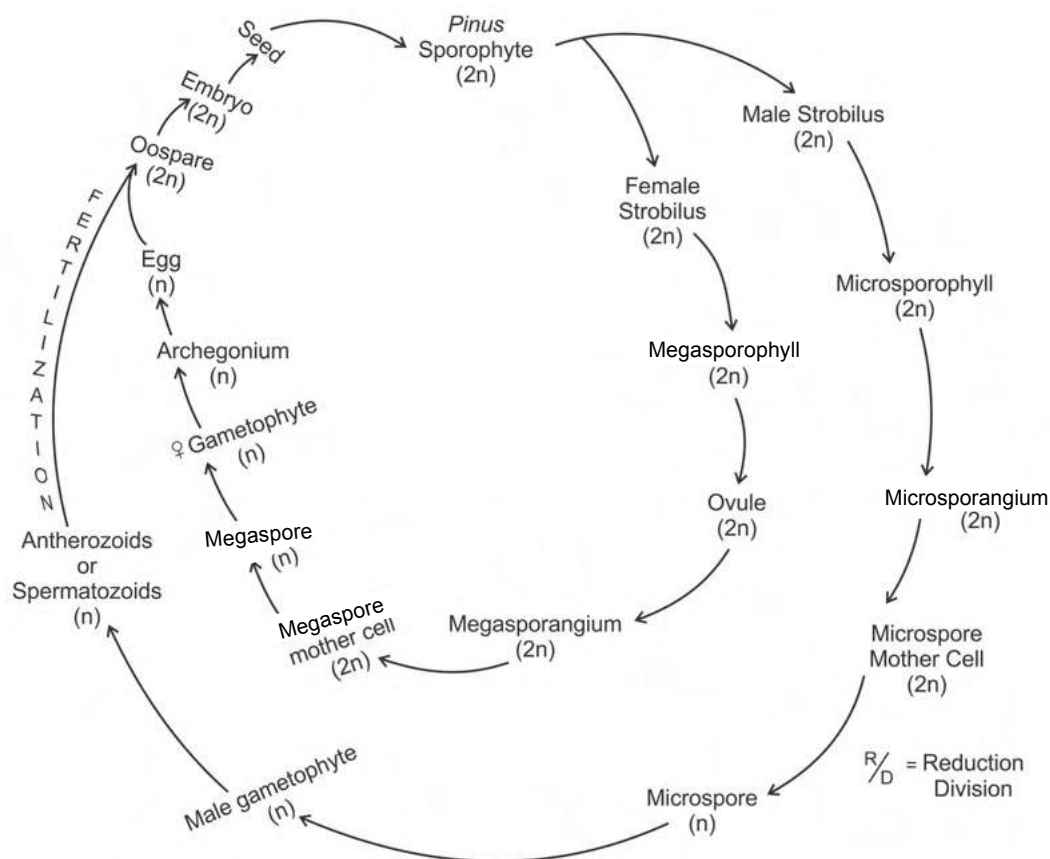

Word diagram 7.2 : Life cycle of *Pinus*

7.7 □ Economic and ecological importance of Gymnosperms

Gymnosperms have enormous economic importance which is described below:

- Gymnosperm as a source of wood:** Though gymnospermic wood is usually deficient of wood fibre but its high cellulose content makes it suitable for the use in the field where strength and durability is not a major concern. The wood is mostly used in preparation of match box, interior decoration, packing box, musical instrument, ply wood, paper pulp etc. In Europe, timber obtained from *Abies alba* is used in the carpentry. Two Indian species *Abies pindrow* and *A. spectabilis* is used mainly in making of ply wood and match box. Among Indian

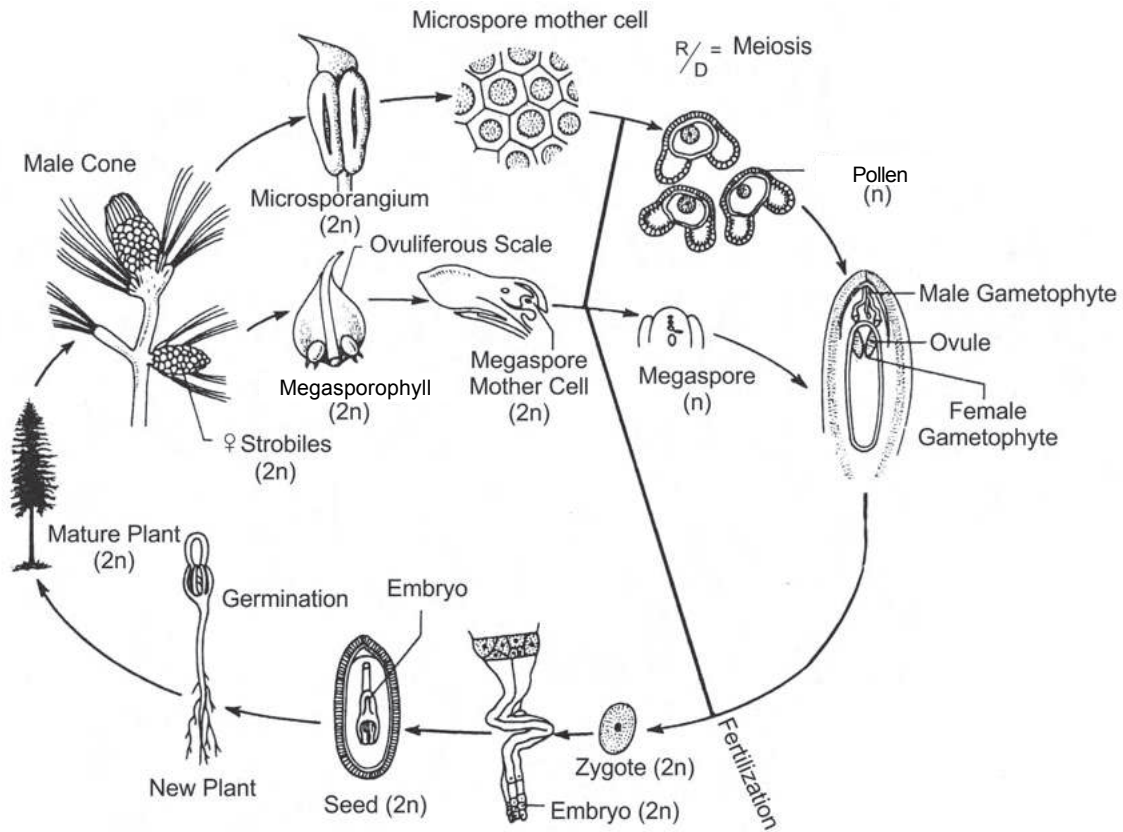

Life Cycle of *Cycas*.

species *Cedrus deodara* is very important since its wood is comparatively stronger and durable. The wood is also resistant to insect attack because of high content of resinous substances. The wood of this species is used therefore in making boat, wagon, furniture, poles etc. The timber of *Cryptomeria japonica* is also durable and in India the timber of this species is used in making roof and window pane. The soft timber obtained from Himalayan species *Juniperus macropoda* is used as pencil wood. The high quality timber yielding species of *Pinus* are *P.caribaea*, *p.palustris*, *P. sylvestris*, *P. contorta*, *P. densiflora* etc. The wood obtained from two Indian species such as *P. roxburghii*, *P. wallichiana* are frequently used in different purposes.

- b) **Gymnosperm as a source of resin:** Gymnosperms are ideal source of resins of high economic value. It is a water insoluble extract that increases longevity of wood by preventing its decay and insect attack. Among the gymnosperms Conifers

are important producer of high quality resin which is used in production of burnishes, enamel, plaster, medicines, and ointments and also as a sizing material of papers. Low quality resins are used in the production of printing ink, soap, oil cloth, insulating agents, adhesives, insecticides, shoe polishes, plastics and many other things. The aldehyde amended resin is mixed with lead and magnesium to produce a compound called metal resinates which is used as paint drier. The different types of resin obtained from gymnosperm is described below:

- i) **Rosin:** Oleoresin obtained from *Pinus* is commonly known as pine gum, pine pitch, turpentine etc. It contains rosin and volatile oil. Rosin is separated by way of distillation of oleoresin. The residue left after distillation of oleoresin is known as **colophony**. The important rosin producers are *Pinus palustris*, *P. nigra*, *P. roxburghii*, *P. caribaea* etc. Pure rosin known as burgundy pitch is obtained from *Picea abies*. Another species *Larix decidua* yields Venetian turpentine which is used in the preparation of burnishes, printing materials, veterinary medicines etc.
- ii) **Copal:** It is a type of hard resin with high melting point. The volatile oil content of this type of resin is low. Copal is available both in fossilised and extant form. The fossilized form of copal known as Kauri copal is obtained from the fossil plant *Agathis australis* which is very much available in Newzealand. Manila copal is another type of copal obtained from another species *Agathis alba*. Copal resin obtained from *Araucaria angustifolia* is aromatic. Wax is added with it to produce aromatic candle. Copal resin has wide application in interior decoration. It is widely used in the production of oil cloth, enamel, printing ink and sprit burnishes. Fresh copal resin of *Agathis araucana* is applied for healing wounds and removing spot of brushes formed due to beating. The other common copal resin yielding species are *Agathis vitiensis*, *A. macrophylla*, *A. ovata*, *A. brownie* etc.
- iii) **Sandarac:** It is a type of hard yellow or orange coloured light weight resin obtained from the stem of Gymnosperms. African sandarac is obtained from *Tetraclinis articulate* and the Australian sandarac is obtained from different species of *Callitris* such as *C. calcarata*, *C. glauca*, *C. verrucosa* etc. Sandarac is mainly used in metal burnishes. Application of sandarac in preservation of painting is not less important. It is also used as a sizing material of gold. Besides, it has wide application in the production of parchment paper, glass adhesive, porcelain etc.

- iv) **Canada balsam:** It is a resin of high refractive index, obtained from *Abies balsamea*, commonly known as balsam fir (Family =Pinaceae). It is used as a mounting medium for study of any biological object under microscope. In glass industry Canada balsam is used to join two lenses. Though *Abies balsamea* is the major producer of Canada balsam, it is also obtained from the species in a little amount like *Pseudotsuga taxifolia*, *Tsuga canadensis* etc.
- v) **Amber:** The fossilized resin of extinct conifer *Pinus succinifera* is known as amber. It is a bright yellow brown coloured crystal. Being multiplaner and transparent, it is used in jewellery. The surface of amber is usually studded with the imprint of different small insects, flowers etc. which not only adds more attractiveness to the crystal but also provides evolutionary information of insects and flowers of prehistoric ages. In X-ray therapy as well as in the preparation of medicine amber is widely used. Amber container is used in the preservation of blood sample because of its preventive property of blood coagulation. Besides, amber could be applied in making cigarette holder and mouth piece of the tube used for smoking.
- c) **Use of Gymnosperm as food:** An edible starch commonly known as ‘sago’ is obtained from the karnel of the seed as well as from the pith of the stem of different species of *Cycas* (e.g. *C. circinalis*, *C. rumphii*, *C. revoluta* etc). The starch obtained from *Zamia* and *Macrozamia* is known as arrowroot. The seeds of these plants are cooked by the tribal of Andaman and Nicobar Island. The seeds of *Pinus gerardiana* are also edible. The edible kernel of *Pinus pinea* is sold in the market of European country. In Italy the kernel of the same species is used in making a special kind of soup. In North America the seeds of the species like *P. cembroides*, *P. edulis*, *P. monophylla* etc. are used in making candy, sweets and nut coffee.
- d) **Gymnosperm as a source of volatile oil:** Almost all conifers produce volatile oil, some of which are used commercially. In Yugoslavia, a volatile oil is obtained from *Picea abies* which is used as a component of room spray and deodorant. Different types of cosmetics are produced from the volatile oil obtained from the species like *Tsuga canadensis*, *T.heterophylla*, *Picea mariana* etc. In India volatile oil of *Cedrus deodara* is used in the production of perfumes and soap. The oil obtained from this species is used for magnification of biological objects at the time of microscopic observation using oil immersion lens. Turpentine oil

is obtained from different species of *Pinus* as a product of distillation of its oleoresin. Such turpentine is used in medicine and in the production of enamel, wax, printing ink and paint. Turpentine is also used as solvent. Different esters of pinic acid are obtained from turpentine which has infection preventive properties. Besides, such esters are used as lubricant of jet aircraft. Volatile oil obtained from *Pinus* is used in metal extraction, painting of clothes and also as germicides.

- e) **Use of Gymnosperm as drug:** Ephedrin alkaloid obtained from different species of *Ephedra* has expectorant property and is used as a component of cough medicine. The alkaloid is obtained from the green branches from the species like *E. equisetina*, *E. gerardiana* etc. It also acts as bronchodilator. The alkaloid has its application in the preparation of nasal drop. The extract of the leaf of *Ginkgo biloba* is used in the treatment of headache. A 20 carbon containing trilactone known as ginkgolide, obtained from this species acts as inhibitory substance of platelets activating factor (Tredici, 1992). Taxol is another important alkaloid obtained from *Taxus brevifolia* which is used in the treatment of breast cancer, colon cancer and ovarian cancer. The leaves of *Taxus baccata* is applied in the treatment of bronchitis, asthma, epilepsy, indigestion etc. As the taxol yield of *Taxus brevifolia* is very low, it requires huge plant materials for extraction of the alkaloid. To meet the demand of these live saving drug huge natural plants therefore need to be destroyed. An innovative conservation strategy has been developed to protect the plant in natural environment. A fungus named *Taxomyces andreanae* lives inside the phloem tissue of the plant can produce the same alkaloid by way of genetic transformation due to its co existence. Now instead of collection of bark from the natural plant, the fungus is artificially cultured to obtain the alkaloid. Thus the strategy serves the dual purpose that is conservation of the plant in nature and extraction of alkaloid.

The dried stem of *Cycas pectinata* is ground and applied to strengthen the hair base. The same powder is used in washing of hairs in the tribal people of Assam. The extract of the young leaves of *Cycas revoluta* is used in the treatment of blood vomiting and gastritis. The pollen grains of *Cycas rumphii* have anaesthetic property. The scales present in the male cone of *C. rumphii* and *C. circinalis* is sold in the Indian market due to their balsamic property.

- f) **Use of gymnosperm as a source of tannin:** Tannin obtained from Gymnosperms is used in leather, petroleum and pharmaceutical industry. The

important tannin yielding species are *Tsuga Canadensis*, *Sequoia sempervirens*, *Picea alba*, *Dacrydium cupressinum* etc.

- g) Use of Gymnosperms in paper industry:** Different species of Gymnosperms are exploited for the production of paper pulp of high quality. Three Indian species such as *Picea smithiana*, *Abies pindrow* and *Pinus roxburghii* are important in this regard.
- h) Gymnosperms as a source of fatty oil:** The seeds of Gymnosperms are ideal source of fatty oil. As the seeds used as a source of fatty oil are also edible therefore use of such seeds for the purpose of extraction of oil has become restricted. The fatty oil obtained from *Cephalotaxus drupacea* is used as fuel in Japan. The fatty oil of *Pinus cembra* is edible and the oil is also used in the production of paint. Similarly the fatty oil of *Torreya nucifera* is edible and the same is applied in production of paint.
- i) Use of gymnosperm in decoration:** Species of *Picea* and *Abies* are used as Christmas tree for beautification of the ceremonial house. Different species of gymnosperms are used in the preparation of bonsai. *Cupressus funebris* is cultivated as ornamental plant in different religious places. The characteristic shape, size and growth habit of the conifer trees add elegance and beauty of the hilly region. Besides, different species of *Thuja*, *Cycas*, and *Araucaria* are cultivated in the garden as ornamental plant.
- j) Ecological role of Gymnosperm:** Gymnosperms have great ecological importance. Although their habitats range from tropical to desert, their centres of dominance are the cool-temperate zones of the Northern and Southern hemispheres. Conifers create ecosystem in the landscape formed by Gymnosperms. Conifer foliage is rich in organic acid, so its decomposition, in turn, makes the soil acidic and relatively low in nutrients. Only those shrub and herb species that can tolerate such soil conditions can grow in such place. The species which are tolerant to low light intensity can grow beneath the dense conifer crown. The acidity of soil where gymnosperms grow also hinders bacteria but favours fungi, so the decomposer microflora is strongly affected. Conifer foliage and wood are high in secondary metabolic compounds that inhibit grazing; therefore, mammals and insect diversity is low, as is that of insectivorous birds. The dense growth of conifers on the hill slope prevents soil erosion. It has been reported that gymnosperms play significant role in the absorption of green house gases from atmosphere and reduce the green house effect.

7.8 □ Summary

Gymnosperms include herbaceous members like *Ephedra*, climbers like *Gnetum ula* or large trees like the conifers. The main plant body is sporophytic. Some members like *Cycas* produce coralloid roots. *Pinus* produces dwarf shoot. Secondary wood may either be manoxylic or pycnoxylic. They are heterosporous. Ovules are naked or exposed. In *Gnetum* female gametophyte is tetrasporic. Fertilization is siphonogamous. *Cycas* has a large ovule with a 3 layered integument. Female gametophyte is tetrasporic. *Pinus* has long and dwarf shoot. The leaves are also two types — foliage leaves and scale leaves. Xylem shows bordered pits and crassulae. Male cones bear microspores. Female cones bear ovules on megasporophyll. *Pinus* ovule is anatropous. *Pinus* shows cleavage polyembryony. Gymnospermous plants are valued for wood, resin, amber, adhesive and some are edible too.

7.9 □ Exercises

Objective Multiple Choice Questions

1. Which of the following gymnosperms produce resin? a) *Cycas* b) *Pinus* c) *Gnetum* d) *Ginkgo*.
2. Which of the following is absent in the archegonium of gymnosperms? a) Neck cells b) Egg c) Neck canal cell d) Ventral canal cell.
3. Amber is related to which of the following genera? a) *Cycas* b) *Pinus* c) *Ginkgo* d) *Gnetum*.
4. Corallorhiza bearing gymnosperm is – a) *Pinus* b) *Cycas* c) *Gnetum* d) *Zamia*.
5. ‘Sago’ is obtained from the species of a) *Cycas* b) *Gnetum* c) *Cephalotaxus* d) *Ginkgo*.
6. Which of the following gymnosperms is used in cough medicine? a) *Cycas circinalis* b) *Pinus edulis* c) *Ephedra sinica* d) *Cedrus deodara*.
7. Who first coined the term gymnosperm? A) Aristotle b) Theophrastus c) Tansely d) Robert Koch.
8. Cancer medicine producing gymnosperm is – a) *Ginkgo biloba* b) *Taxus brevifolia* c) *Cycas rumphii* d) *Pinus pinea*.

9. What is sandarac? a) It is a type of yellow resin b) A kind of starch obtained from the stem of *Cycas*. c) An alkaloid used to treat cancer. d) A cough medicine.
10. The gymnosperms are – a) Insect pollinated b) Water pollinated c) air pollinated d) animal pollinated.
11. The endosperm of gymnosperm is – a) haploid b) diploid c) triploid d) tetraploid
12. The ovule of *Cycas* is a) Orthotropous b) Anatropous c) Hemianatropous d) Campylotropous.
13. Which of the following gymnosperms is commonly known as Chilgoza? a) *Pinus gerardiana* b) *Thuja* c) *Pinus wallichiana* d) *Cycas revoluta*.
14. Which of the following gymnosperms is called living fossil? a) *Gnetum* b) *Ginkgo biloba* c) *Taxus baccata* d) None of the above.
15. The spermatozoids of *Cycas* are- a) Large multiciliated b) Small non ciliated c) Large nonciliated d) Small non motile
16. Transfusion tissue of *Cycas* helps in – a) Photosynthesis b) Storage c) Conduction d) Respiration

Answers: 1(b), 2(c), 3(b), 4(b), 5(a), 6(c), 7(b), 8(b), 9(a), 10(c), 11(a), 12(a), 13(a), 14(b), 15(a), 16(c).

1. Write two important features of the pollen of *Pinus*. (Ans. See section 7.6.3.3)
2. Mention two salient features of gymnosperms. (Ans. See section 7.4)
3. Distinguish between the endosperm of angiosperm and gymnosperm. (Ans. See section 7.4)
4. What is meant by shower of sulphur? (Ans. See section 7.6.3.3)
5. What is transfusion tissue? Mention its functions. [Ans. See section 7.5.3.2(iv)]
6. What is polyembryony? (Ans. See section 7.4)
7. Why fruits are not produced in gymnosperm? (Ans. See section 7.4)
8. What is coralloid root? (Ans. See section 7.5.1)
9. What is ovuliferous scale? (Ans. See section 7.6.3.3)
10. Mention two xerophytic characters of the leaves of *Pinus*. (Ans. See section 7.6.1)

11. Name one gymnosperm where archegonium formation does not occur. (Ans. *Gnetum*)
12. Distinguish between manoxylic and pycnoxylic wood. (Ans. See section 7.4)
13. Name the layers of integument of *Cycas* ovule. (Ans. See section 7.5.5.4)
14. What is nucellar cap? (Ans. See section 7.6.3.7)
15. What is copal? [Ans. See section 7.7b(ii)]
16. What is Canada balsam? [Ans. See section 7.7b(iv)]
17. What is taxol? Mention its source and uses. [Ans. See section 7.7(e)]
18. What is ephedrine? Mention its source and uses. [Ans. See section 7.7(e)]
19. Distinguish between long and dwarf shoot. (Ans. See section 7.6.1)

Suggested Readings

- Alexopoulos, C.J, Mims, C.W. and Blackwell, M. Introductory Mycology, John Wiley & Sons.;
- Atlas, R.M. Principles of Microbiology, Mc Graw Hill
- Bhatnagar, S. P. & Moitra, A. Gymnosperm; New Age International.
- Dubey, R.C., Maheswari, D.K., A Text Book of Microbiology, S. Chand and Company Pvt. Ltd.
- Ganguly et al; College Botany (Vol II) New Central Book Agency, Kolkata.
- Ganguly, H.C & Kar, A.K. College Botany Vol. II, New Central Book Agency.
- Ganguly, H.C. & Kar, A.K., College Botany Vol II, New Central Book Agency.
- Ganguly, H.C. and Kar, A.K. College Botany Vol II New Central Book Agency.
- Gifford, E.M. & Foster, A.S. Morphology and Evolution of Vascular Plants, Freeman and Co.
- Kumar, H.D. and H.N. Singh; A Text Book on Algae, 3rd ed., Affiliated East-West Press Pvt. Ltd., New Delhi, 1982.
- Parihar, N.S. Introduction to Embryophyta: Vol.I Bryophyta, Central Book Depot.
- Pelczar, M.J., Chan, P.C.S. & Krieg, N.R., Microbiology, Tata Mc Graw Hill.
- Prescott, L. M., Harley, J.P., Klein, D. A., Microbiology (6th edition), Mc Graw Hill.
- Rashid, A., An Introduction to Bryophyta, Vikash Publishing House.
- S. N. Pandey and P.S. Trivedi; A Text Book of Algae, Vikash Publishing House Pvt. Ltd. 1996.
- Sharma, O.P. Text book of Algae (Tata Mc Graw Hill).
- Sharma, P.D., Fungi and Allied Organisms, Narosa Pub. House.
- Sikdar, J. Sen, K. Giri, P. Snatak Udvidbidya, Sem III, Santra Publication Pvt. Ltd.
- Sikder, J. Sen, K, Giri, P. Prarambhik Udvidbidya, Vol I ; Santra Publication Pvt. Ltd.

- Smith, G.M. Cryptogamic Botany Vol I (Tata Mc Graw Hill)
- Sporne, K.R. The Morphology of Gymnosperms; Hutchinson University Library.
- Sporne, K.R. The morphology of Pteridophytes , Hutchinson & Co.
- Stanier, R.Y., Ingraham, J.L., Wheelis, M.L. & Painter, P.R., General Microbiology, Macmillan Education Ltd.
- Vashista, B.R. Bryophyta, S. Chand & Co.
- Vashista, B.R., Sinha, A.K., Kumar A, Botany for Degree Students Fungi; S.Chand & Company Pvt. Ltd.
- Vashistha, B.R., Singh, A.K. and Singh, V.P., Algae (S, Chand & Co. Pvt. Ltd.)
- Vasishta, P.C. Gymnosperm; S.Chand & Company.
- Vasishta, P.C. Pteridophytes, S.Chand & Co.
- Webster, J., Introduction to Fungi , Cambridge University Press.

NOTES

NOTES
